

DICK SMITH'S FUN WAY INTO ELECTRONICS

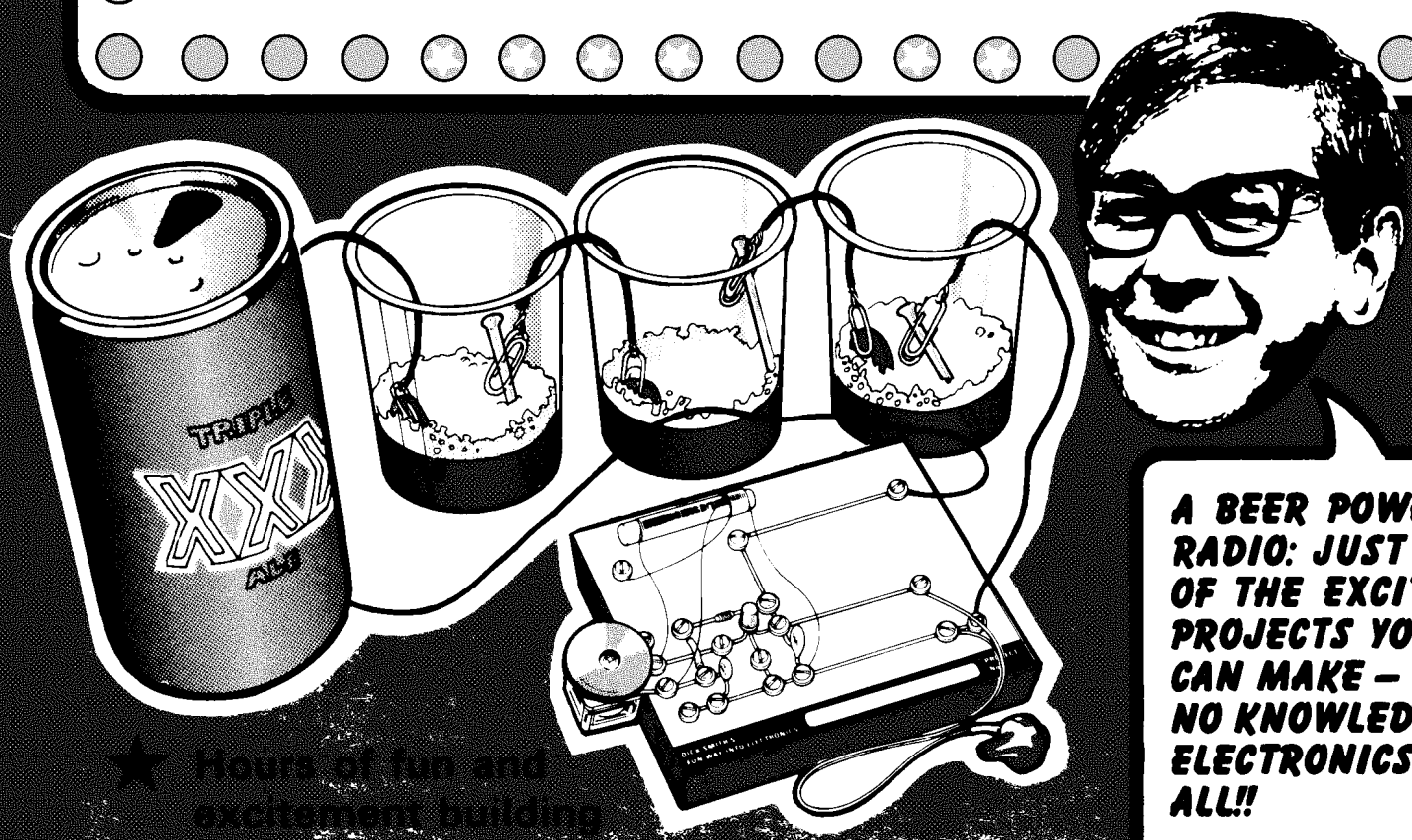

**A BEER POWERED
RADIO: JUST ONE
OF THE EXCITING
PROJECTS YOU
CAN MAKE - WITH
NO KNOWLEDGE OF
ELECTRONICS AT
ALL!!**

- ★ Hours of fun and excitement building 20 educational projects
- ★ Completely safe - ideal for all ages
- ★ Find out what electronics is all about - the fun way!

**ONLY
\$495***

written by DICK SMITH

EIGHTH PRINTING

**NO SOLDERING
REQUIRED**

DICK SMITH'S

Edited by Sam Voron & Ross Tester
Illustrated by Mike Middleton

Introduction	4
Getting started – and what you’ll need	5
What the components look like	6
How to read component codes	11
Making a success of your projects	12
Full list of the components we use	13

The projects:

1:A continuity indicator	14
2:A transistor tester.....	18
3:A water indicator	20
4:A light/dark indicator	22
5:The flasher	24
6:An electronic siren.....	26
7:A dog and cat communicator.....	28
8:A decision maker	30
9:Morse code communicator	32
10:Music maker	34
11:A sound effects generator.....	36
12:A crystal set.....	38
13:A one transistor amplifier	40
14:A beer powered radio.....	42
15:A two transistor amplifier	46
16:The world’s simplest transmitter.....	48
17:A more powerful transmitter	50
18:A CB radio receiver	52
19:An amateur radio receiver.....	54
20:A radio booster amplifier.....	56

About radio transmission and reception	58
--	----

The technical terms we use in this book.....	61
--	----

Cut-out project board overlays:

Projects 1, 2, 3, & 4.....	63
Projects 5, 6, 7, & 8.....	65
Projects 9, 10, 11, & 12.....	67
Projects 13, 14, 15, & 16.....	69
Projects 17, 18, 19, & 20.....	71

Let me introduce you to my fun way into electronics.

When I was eight years old, I became interested in radio. I still remember the night I built my first crystal set. Imagine the joy I experienced when it actually worked!

That night was the beginning of my career.

Not long afterwards, I started learning about radio and electronics, building projects as I went. The method I used was simple: take a piece of wood, and lay the components out in exactly the same pattern as the circuit. It might not have been the most technically correct method, but it sure taught me a lot about electronics and the way components work in circuits!

When I left school, I started my own electronics business. Now, along with many other electronics enthusiasts who started in similar ways to myself, we have a multi-million dollar, fully Australian owned electronics company.

I would not be in electronics if I did not love it as a hobby and have faith in its future. I hope my book will help you become part of this future.

You will find that it uses exactly the same approach in constructing projects as I did many years ago – simple breadboard wiring that is the same as the circuit diagram – with no soldering required!

If you are wanting to learn about electronics as a hobby, or have electronics in mind as a career, you'll find no better way of learning. I am sure you will find this book gives you the fun and enthusiasm that electronics gave me when I began, and still gives me today.

Have fun!

Dick Smith
VK2ZIP



This book is designed for the person who does not know a thing about electronics but would like to learn. Whether you are six or sixty, you will appreciate the simple and easy construction methods and descriptions. In no time at all you will be having fun constructing entertaining and educational projects.

All of the projects in this book actually do something: they work. While some of them, or their uses, might appear trivial to some, what you have to remember is that each project can be regarded as a 'building block'. All electronic circuits are really a number of these 'building blocks' strung together. For example, later in the book is a project called 'A decision maker'. You might wonder what on earth a circuit like this could be used for.

It may come as a surprise to learn that today's incredibly complex electronic computers contain thousands of circuits developed from this one!

Of course, computers use very involved construction techniques – but that is getting a little ahead of ourselves.

In order to make construction extremely easy without soldering (making it safe for even the youngest person) we use a method called 'bread-boarding'.

This involves some scraps of particle board (or other suitable board) 10cm x 12cm or slightly larger, and some self-tapping screws and washers.

The electronic components and wire links which actually make up the circuit are connected between these screws according to a plan printed in the back of this book. This plan shows the arrangement of components we have found to be most satisfactory, arranged according to a 'grid' of 1cm squares. Also marked on the plan is the position of each of the screws which hold the components in position.

The idea is to remove the overlay from the back of the book and glue it onto your particle board. (While we recommend particle board because of its availability and cheapness, any material can be used as a baseboard as long as it will not conduct electricity and is fairly easy to screw into. Note you cannot use any metallic material as the baseboard).

Once the plan is glued onto the baseboard, you can insert the screws in the positions shown and connect the components and wire links as shown by the plan underneath.

The result: an instant electronic circuit!

To summarize, then, You will need:

A 10cm x 12cm baseboard (we used 12mm particle board, but other board would be suitable)

Up to 28 self-tapping screws and washers to suit (No. 4, 12mm long self-tappers and 4BA washers are fine).

Hookup wire and tinned copper wire

Components as per individual parts lists, or see the full components listing on page 13.

Plus the following tools:

A small screwdriver and a pair of cutters or combination cutter/pliers.

A pair of scissors to cut out the project overlays.

A sharp knife or single edged blade to scrape insulation from some of the wire.

And finally, you must want to enjoy yourself!

If you're unsure about the technical terms we use in this book, you'll find them listed in a glossary on pages 61 and 62.

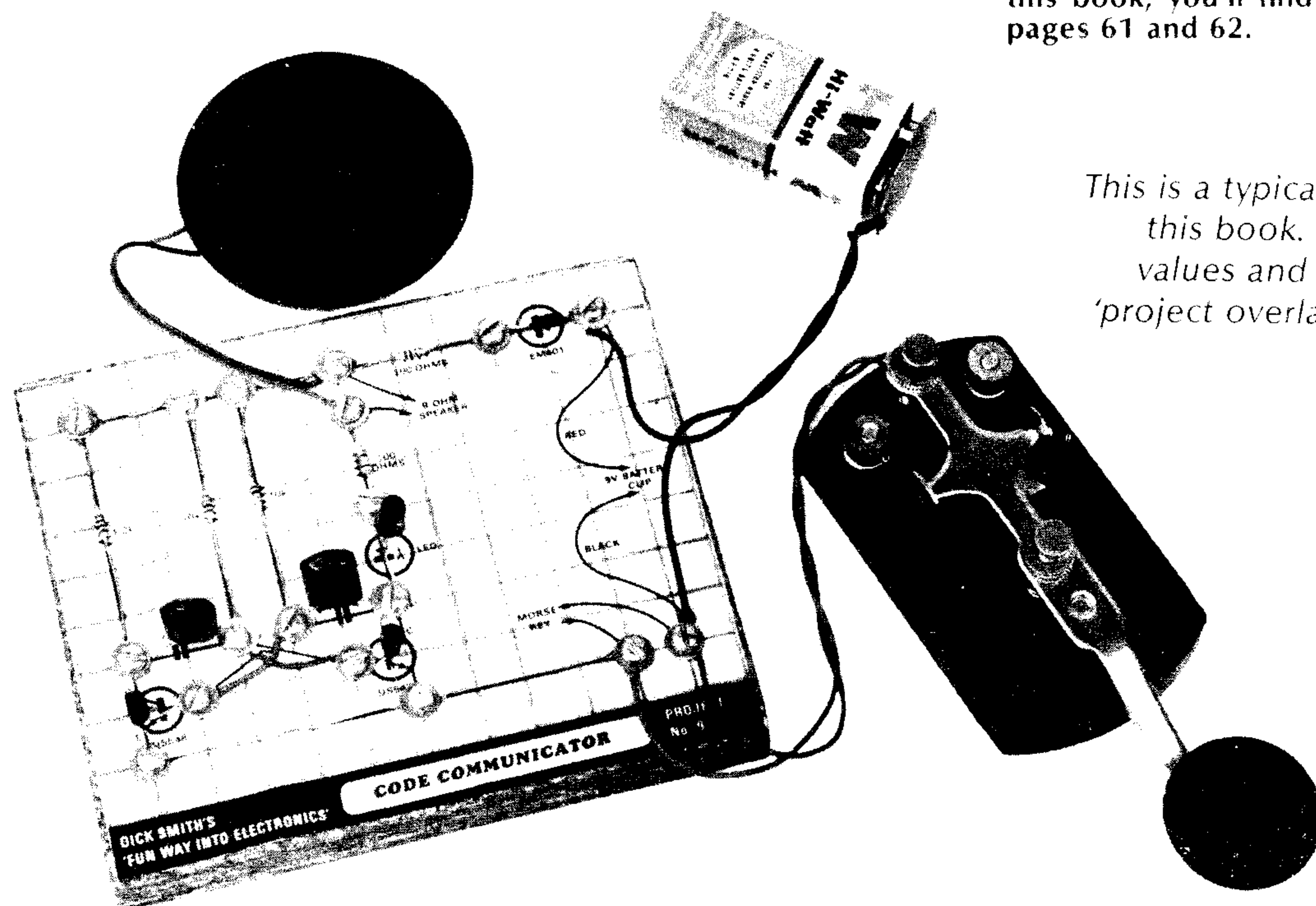

This is a typical example of one of the projects in this book. As you can see, all the component values and positions have been shown on the 'project overlay' which is glued to the baseboard before the circuit is assembled.

Screws and washers hold all of the components and links, etc, in position.

BATTERY (and battery clip):
 Type 216 – 9 volt transistor
 radio battery.
 (Dick Smith Cat. No. S-3001)
 (Battery clip Cat. No. P-6216)

Contains special chemicals which react together to create a pushing force or voltage, which causes current to flow. To prevent incorrect connection to the battery we use a special clip which fits one way only: the red lead is positive, and the black lead negative. Components which must be connected into circuit the correct way around are said to be polarised.



CAPACITORS:

Capacitors store electric charges. The higher the capacity, the more electric charge the capacitor can store. Capacitance is measured in microfarads (μF) and picofarads (pF).

Capacitors are marked with both their capacitance value and a voltage rating. If this voltage rating is exceeded, the capacitor can be seriously damaged. However, it is almost always permissible to use a capacitor with a **higher** voltage rating than the one called for. For example if a circuit specified a $1\mu\text{F}$ 10 volt capacitor, you could use a $1\mu\text{F}$ 15 volt, 50 volt or even 1000 volt (if you could find one!) without any problems. You could not, however, use a $1\mu\text{F}$ 9 volt or anything lower.

POLYESTER:

Often called 'greencaps' because they are usually green, these capacitors are used mainly in audio circuits. They range in value from a few microfarads to around $.001\mu\text{F}$. They are not polarised.



DISC CERAMIC:

These look like small discs – hence the name. They range in value from $0.47\mu\text{F}$ or so down to 1pF . You can often use a disc ceramic when a polyester is called for, but the reverse is not always the case. They are not polarised.



ELECTROLYTICS:

Electrolytics **are** polarised – they are normally clearly marked so you can't mix the connections up. They range in value from around $0.5\mu\text{F}$ up to hundreds of thousands of microfarads.

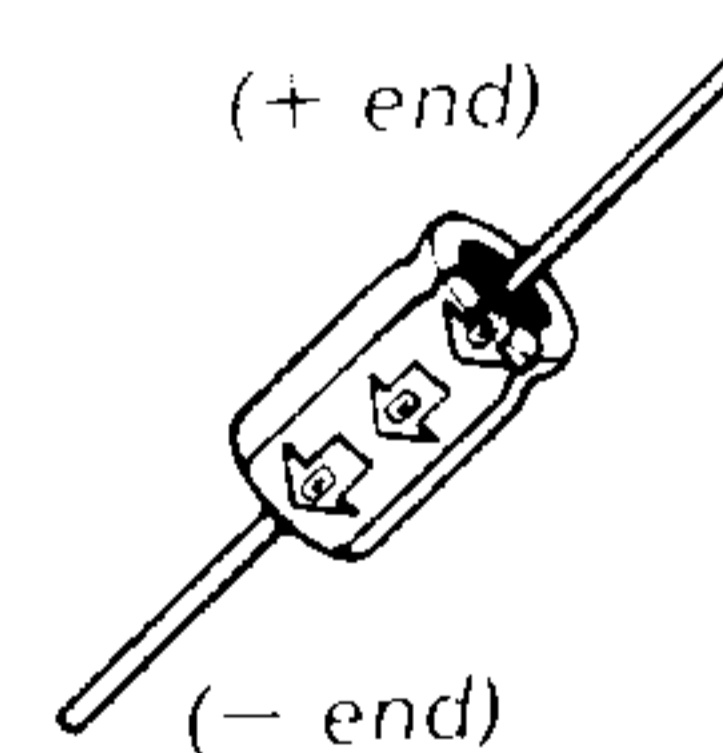

VARIABLE:

As its name suggests, the capacitance of this type can be varied by turning a shaft. It has a capacitance range of from 60 to 160pF (other variable capacitors may have different ranges).

We use only two of the three terminals on the variable capacitor. These may be labelled 'A' or 'G'; ignore the third terminal. It is used only for support in our circuits; however it can be when all three terminals are used that the variable capacitor is polarised. Always connect it as shown.

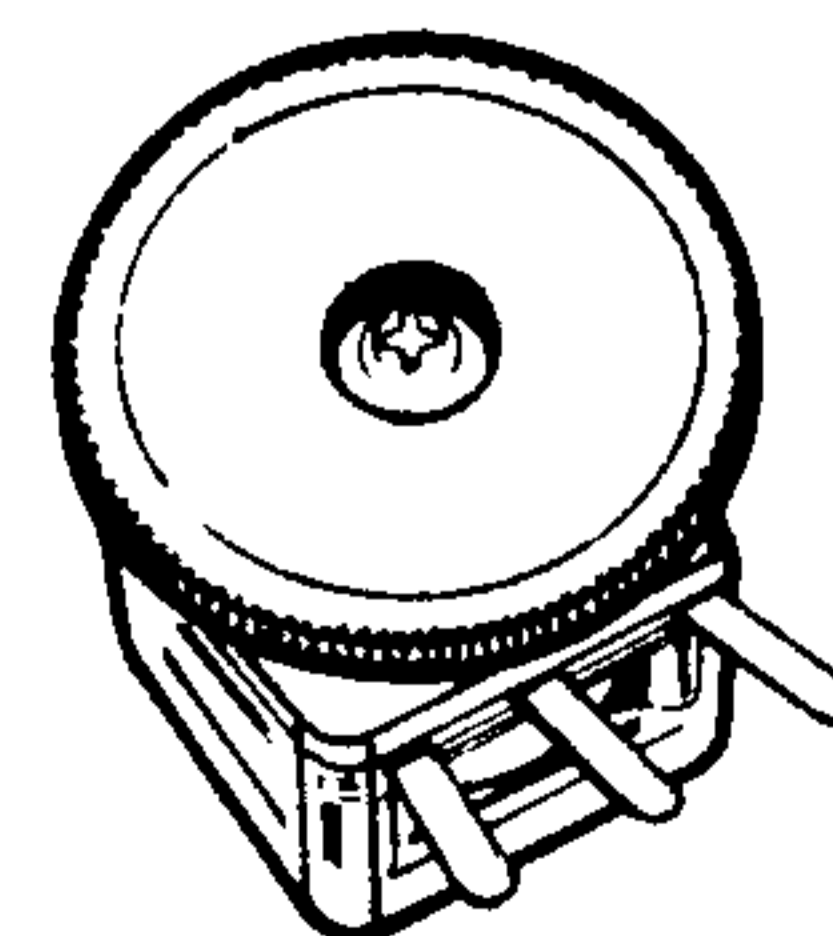

CRYSTAL EARPHONE:

The earphone converts tiny electric currents into sound waves. This earphone has a very high resistance. Normal hi-fi headphones, which have a very low impedance, will not work in these circuits. The earphone is not polarised.

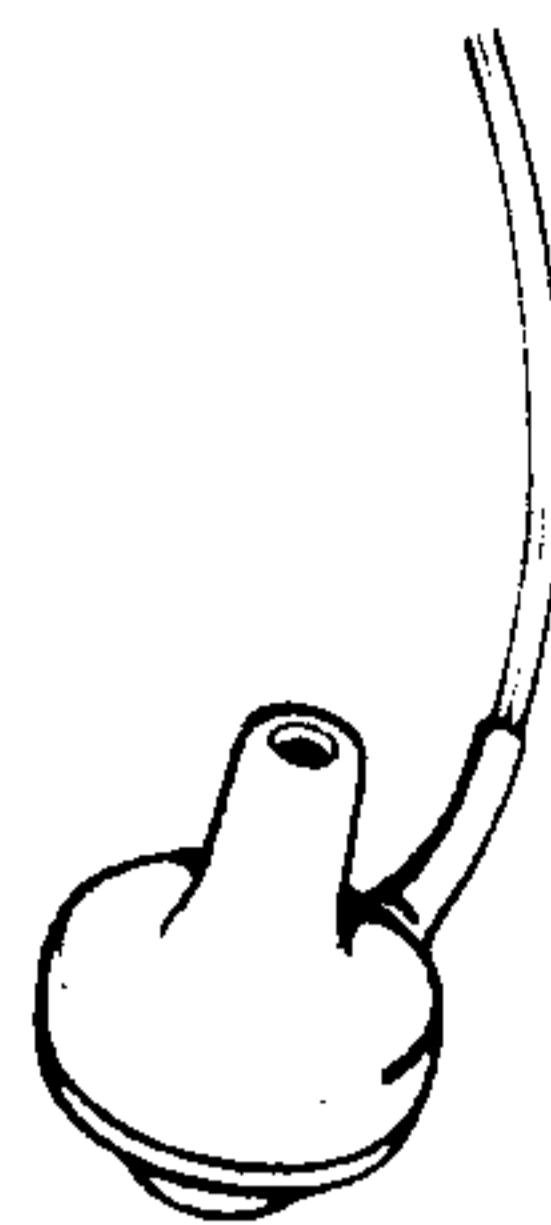

CRYSTAL MICROPHONE:

The earphone can be used 'back-to-front' – that is, converting sound waves into electric currents. In this way, it is being used as a microphone. Simply speak into the part you would normally place in your ear. Once again, it is not polarised.



DIODES:

There are a number of different types of diode. We use three of these types. They have differences, of course, but they have one basic feature in common: they let current flow in one direction only. Diodes are, therefore, polarised. You must place them correctly in circuits, otherwise they may not work and could be damaged.

POWER DIODES:

Type IN4001 or similar
(Dick Smith Cat. No. Z-3202)

In this book we use power diodes for one reason only: to protect the circuits against inadvertent reversal of the battery. These diodes are unlikely to be effected by reverse polarity: they simply will not work!

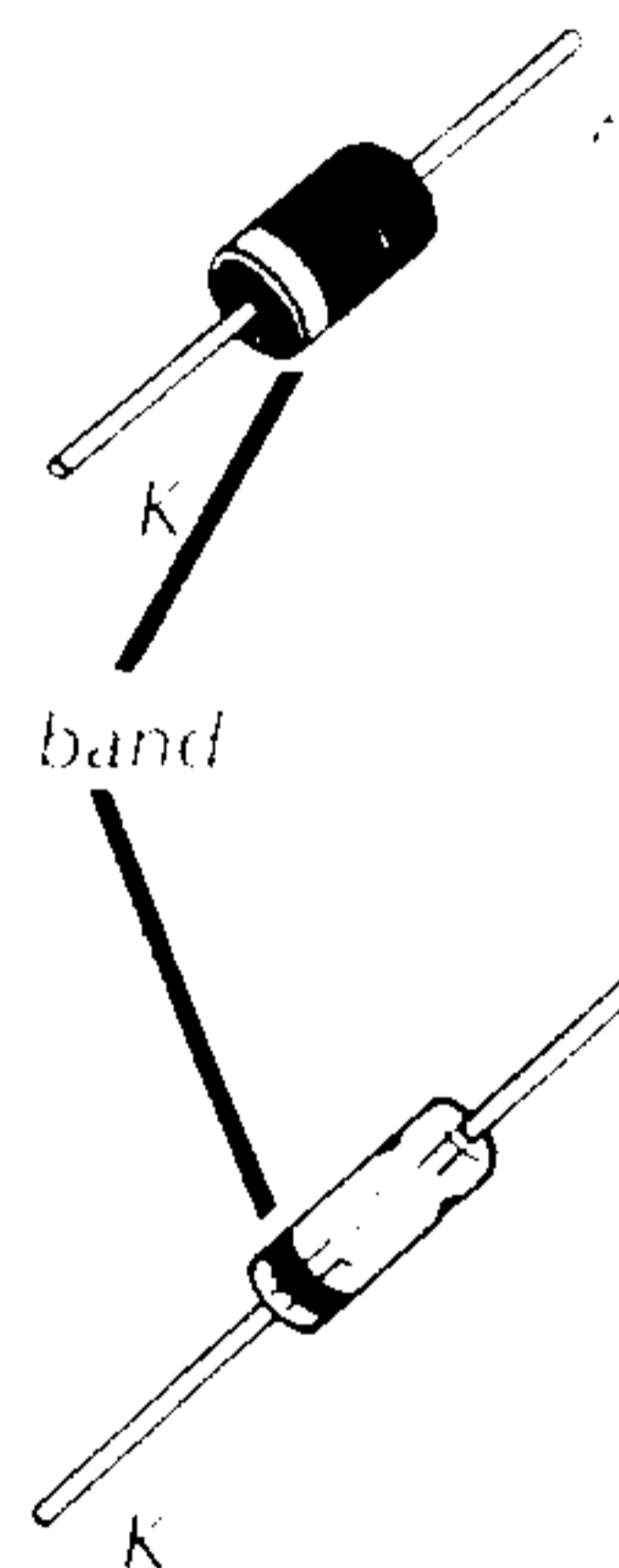

SIGNAL DIODES:

Type OA91 or similar
(Dick Smith Cat. No. Z-3040)

Signal diodes are used in our circuits to detect radio frequency currents. In these circuits, once again they probably wouldn't be upset by wrong polarity: indeed they would probably still work! (We know this contradicts what we said before about diodes having to be connected the correct way around!)

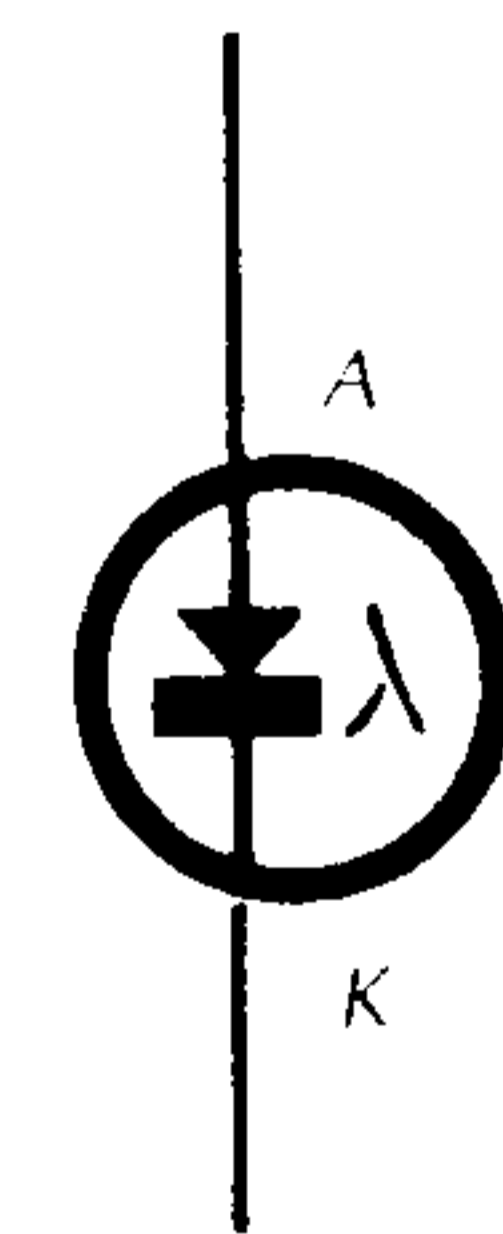
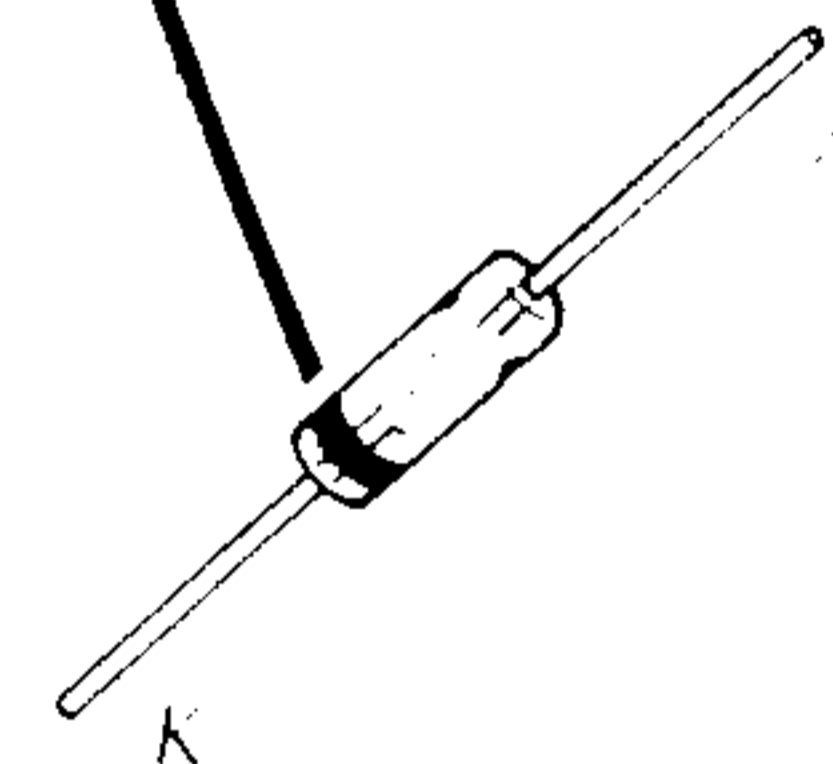

LIGHT EMITTING DIODES:

Red
(Dick Smith Cat.No. Z-4010)

Called LEDs for short, these do get upset with reverse polarity. When correctly connected, they glow brightly. Their polarity is shown in two ways: they normally have a longer lead for the anode, and the cathode is often marked by a slight flattening on the body of the LED adjacent to it.

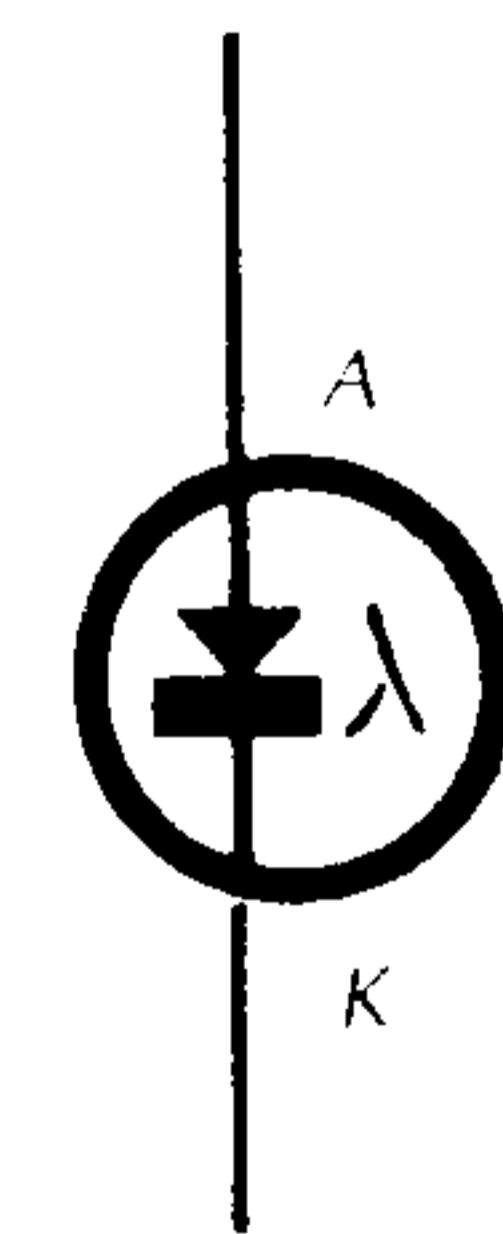
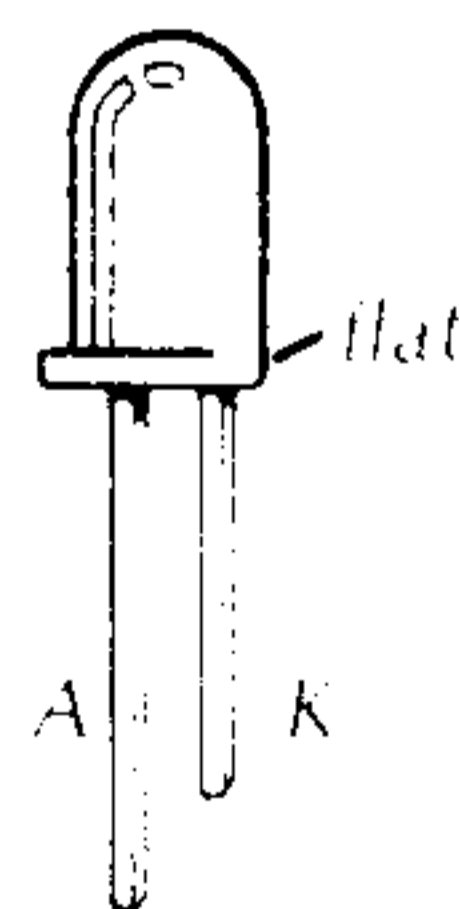

FERRITE ROD AERIAL:

Small transistor radio type,
two coils.
(Dick Smith Cat. No. L-0520)

The ferrite rod aerial concentrates radio waves, in some cases eliminating the need for a separate aerial. Normally with two coils, typically they are coloured red and pink. However, this need not always be the case. The wire in these is very fine: care must be taken to avoid breaking it.

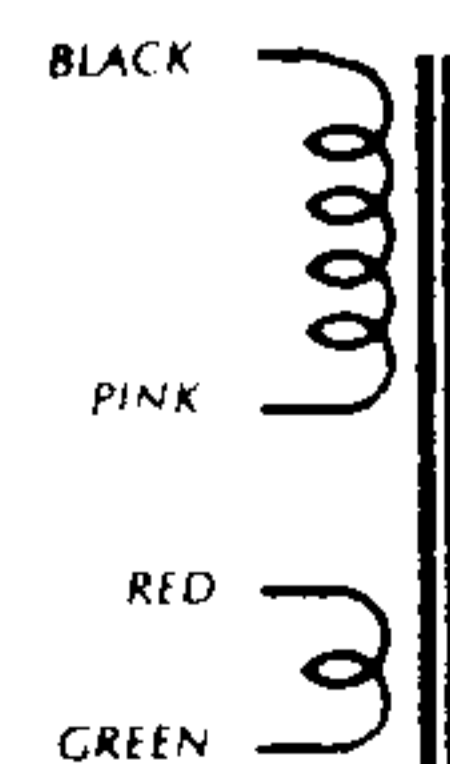
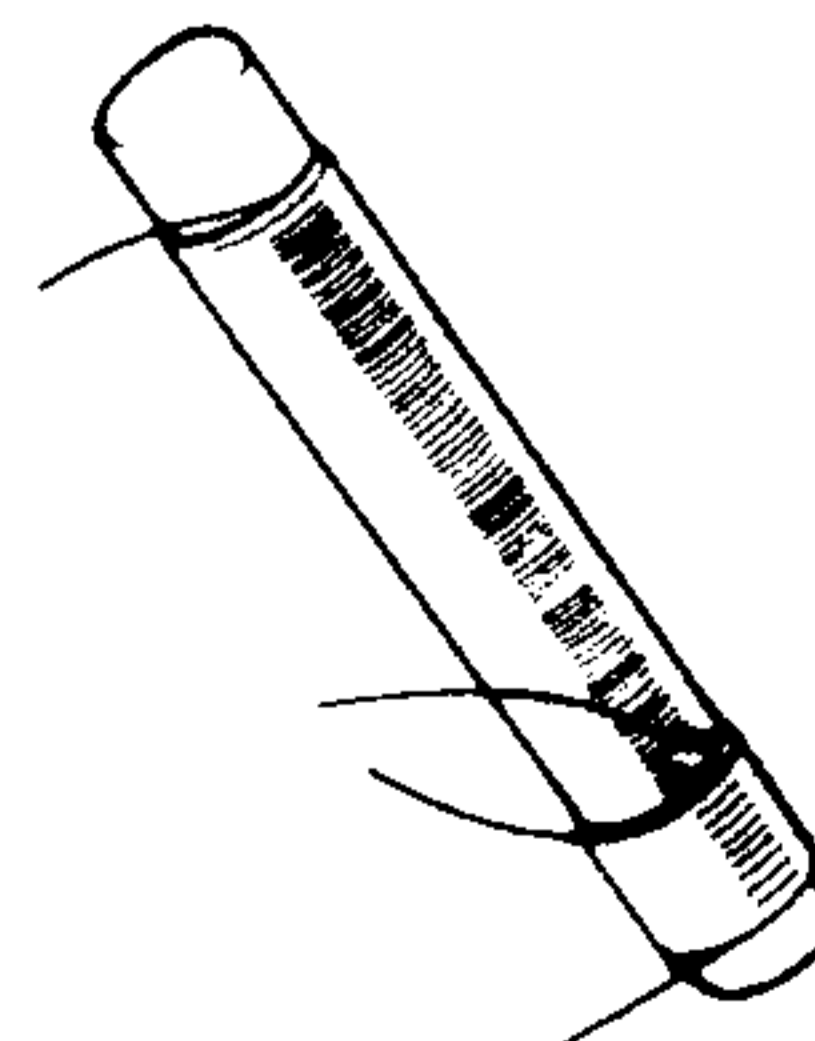

HOOK - UP WIRE:

We use two different types of hook-up wire. For ordinary links, we use tinned copper wire (which can usually be saved from the excess component leads you will cut off); and insulated hook-up wire. You need to remove about 5mm of insulation from each end of the wire before you can use it – this is an art that will come with practice.

Where wires connect to each other, we mark the circuit with a dot. Here you use ordinary tinned copper wire.

Where two wires cross but do not connect, insulated hook-up wire must be used for at least one of them. We show this with a loop in the circuit diagrams.

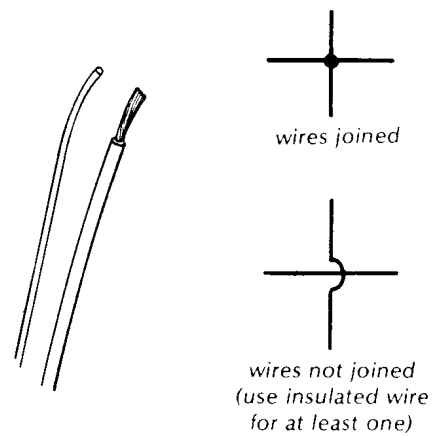

INTEGRATED CIRCUIT (IC): Type ZN-414 (Dick Smith Cat. No. Z-6520)

The integrated circuit we use contains almost all the circuitry for a radio receiver. Hundreds of components are packed into the tiny package!

The IC is polarised – the accompanying diagram shows how it must be connected into the circuit. Take care that you do not short out the leads to each other or to the metal case.

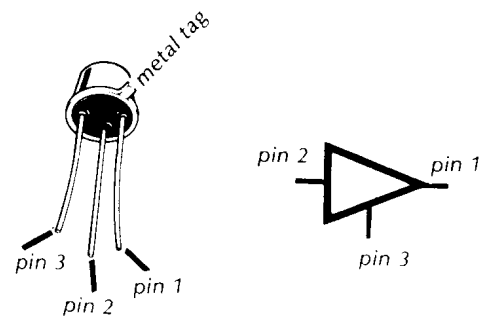

LDR (Light Dependent Resistor): See 'resistors'

LED (Light Emitting Diode): See 'diodes'

LOUDSPEAKER: 8 ohm type, 60mm diameter. (Dick Smith Cat. No. C-2222)

Like the earphone the loudspeaker changes current into sound waves.

Contrary to popular belief, a larger speaker will give more volume than a small speaker from the same source. If you can afford a larger speaker the results will be well worth the extra expense.

The leads can be connected either way in our projects.

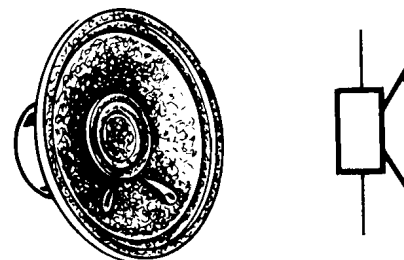

LOUDSPEAKER AS A MICROPHONE:

You can use a loudspeaker as a microphone by connecting an audio transformer to it. The 8 ohm side of the transformer (the two lead side) connects to the speaker terminals, while the outer two leads on the three lead side are used to go to the input of the amplifier, transmitter, etc.

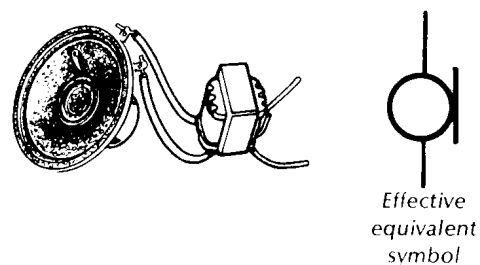

MORSE KEY:
Economy model
(Dick Smith Cat. No. D-7105)

A Morse 'key' is simply a switch which controls the current flowing to the circuit. When the key is pressed, current flows – and the tone sounds. The key can be adjusted to give a 'pitch' (the distance between the contacts) and a 'tension' (the force needed to press the key) that suits the operator best. The key is not polarised. The key can be used as an on/off switch in any of the projects simply by inserting it in series with the battery, in either the negative or the positive side.

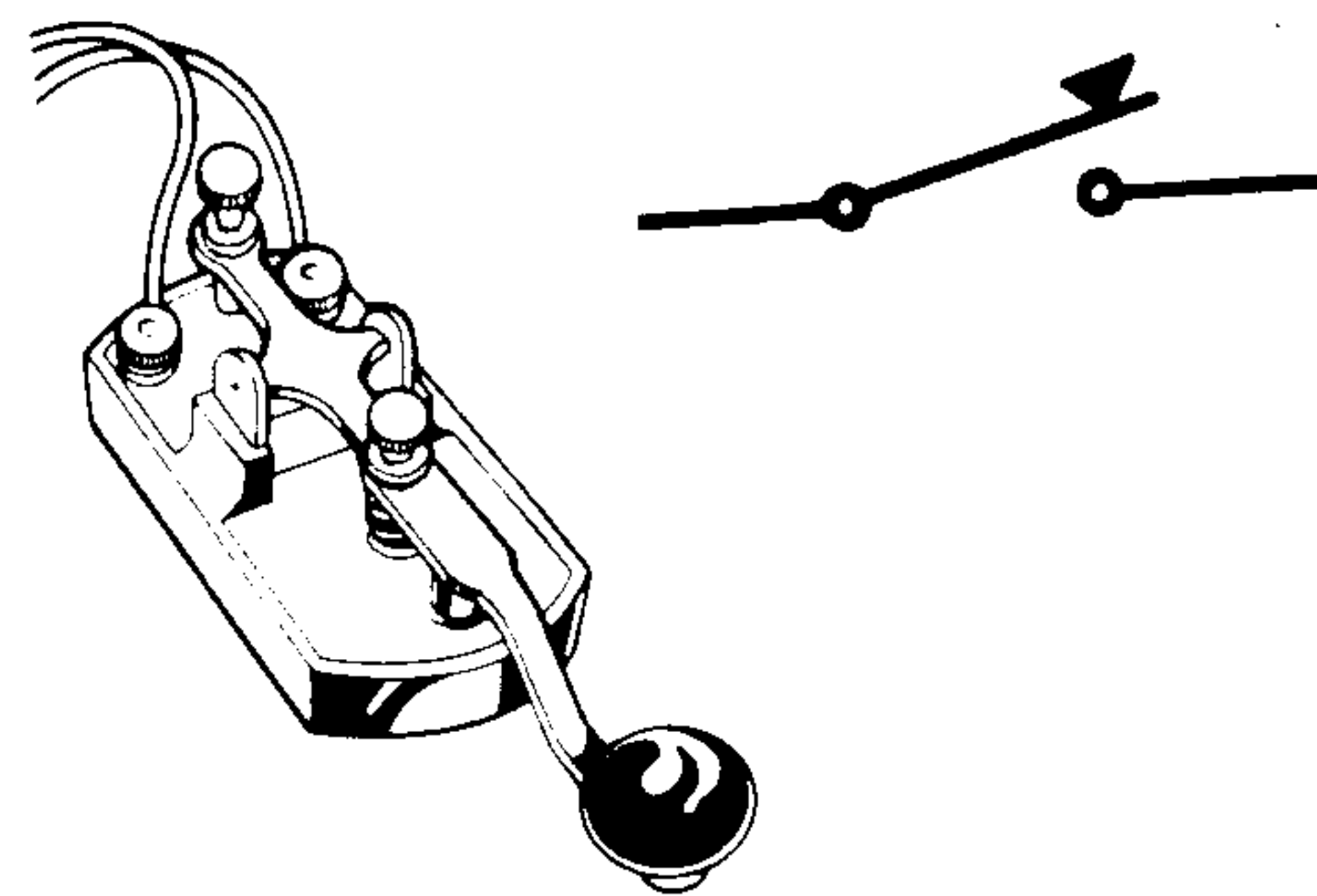

MICROPHONE:

See either 'crystal microphone' or 'loudspeaker as a microphone'.

POTENTIOMETER:

See 'resistors'

RESISTORS:

Are neither insulators nor conductors: they are somewhere in between, allowing some current to flow. The lower the resistance, the more current can flow. Resistance is measured in ohms. Resistors are used to limit current to values which can be used by the various components; too much current and the components may be damaged. Resistors also have a 'power' rating: they must not be called upon to pass too much current or this power rating is exceeded and the resistor may be damaged or destroyed. Our projects use 1/4 or 1/2 watt resistors, about the lowest rating commonly available. However, like capacitor voltage ratings, it is in order to use higher rated components.

FIXED VALUE RESISTORS:
Various values, 1/4 or 1/2 watt.

Fixed value resistors are marked with a colour code. Refer to the colour code on page 11 so you will be able to identify each resistor used in these projects. Resistors are not polarised.

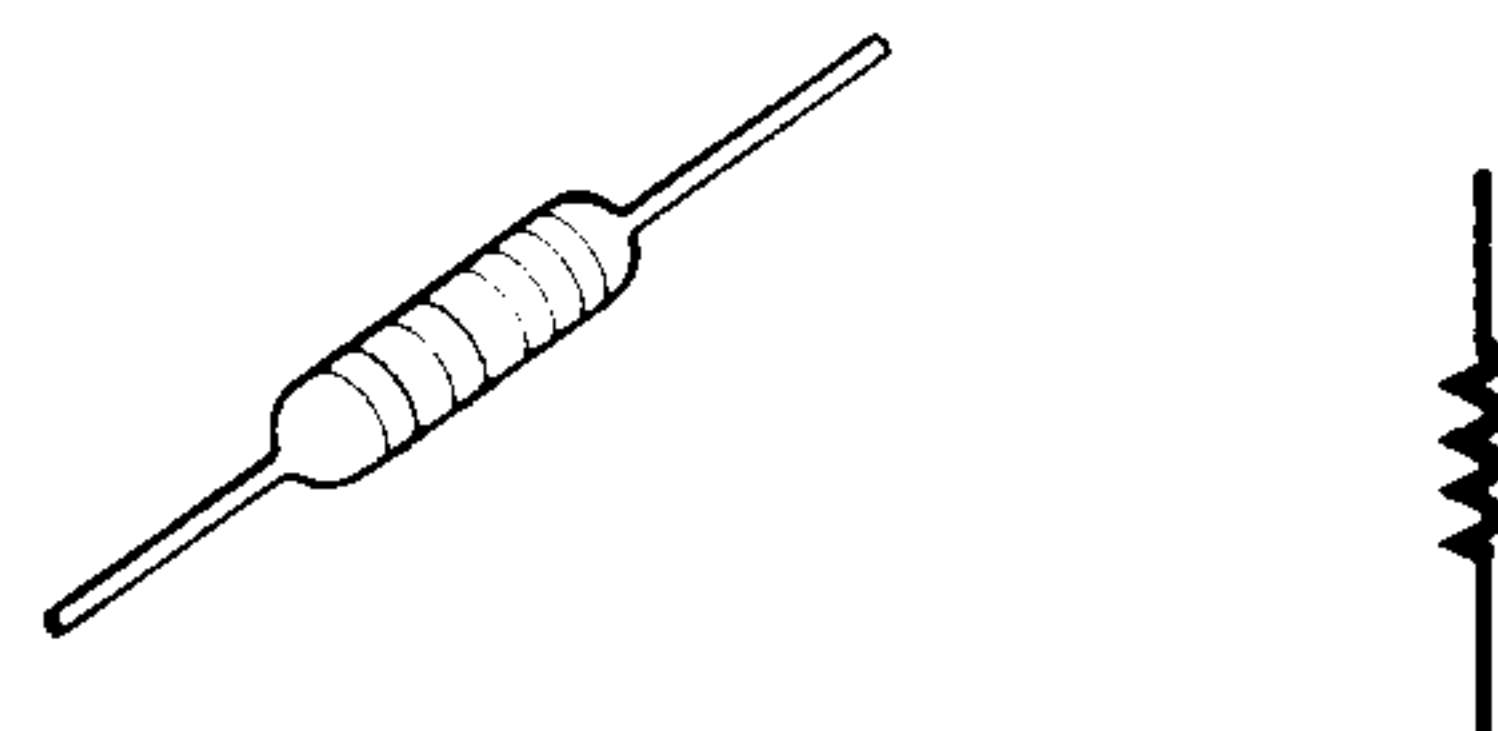

VARIABLE RESISTORS:
or 'potentiometers'
500k, linear or logarithmic.

A potentiometer is merely a fixed value resistor with special sliding arm which allows you to select as much of the resistance value as you want by turning a control shaft. Potentiometers, therefore, have three terminals: one each connected to the ends of the 'resistor' element itself, and one connected to the sliding section. Sometimes an extra pair of terminals is provided on the rear of the case – this is an on/off switch, also actuated by the shaft. Potentiometers are sometimes polarised: check the circuit for connection details.

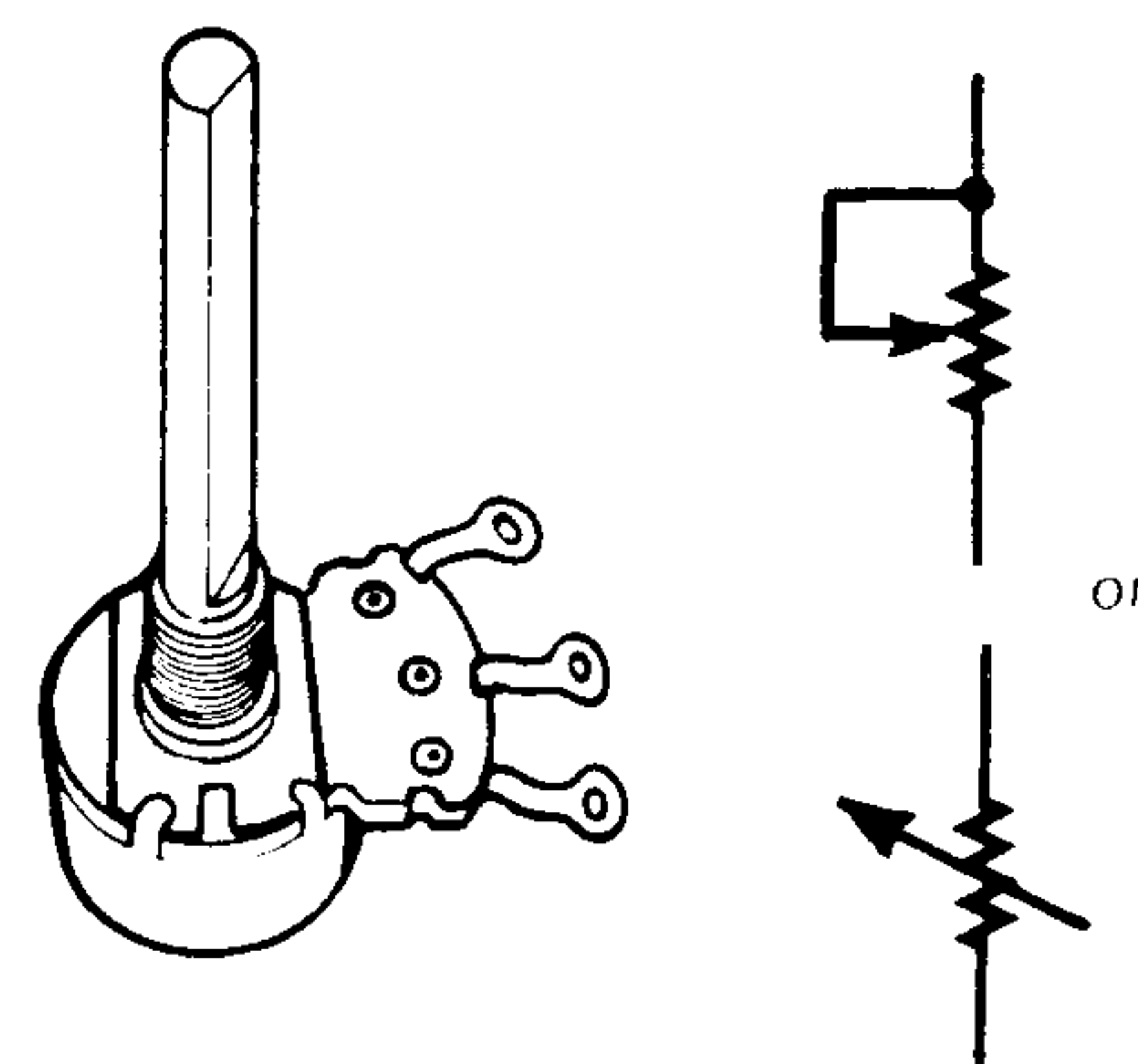

LIGHT DEPENDENT RESISTORS:
(Type ORP12 or similar,
Dick Smith Cat. No. Z-4800)

Obviously, this resistor is effected by light. In its 'dark state' its resistance is very high – millions of ohms. In bright light, this falls to just a few hundred ohms. The resistance changes as the light level changes; therefore it is handy for monitoring light levels. It is not polarised.

Alternatively: Type DSE12 double LDR (Dick Smith Cat No. Z-4802). Has three leads, use two outer leads and ignore the centre one.

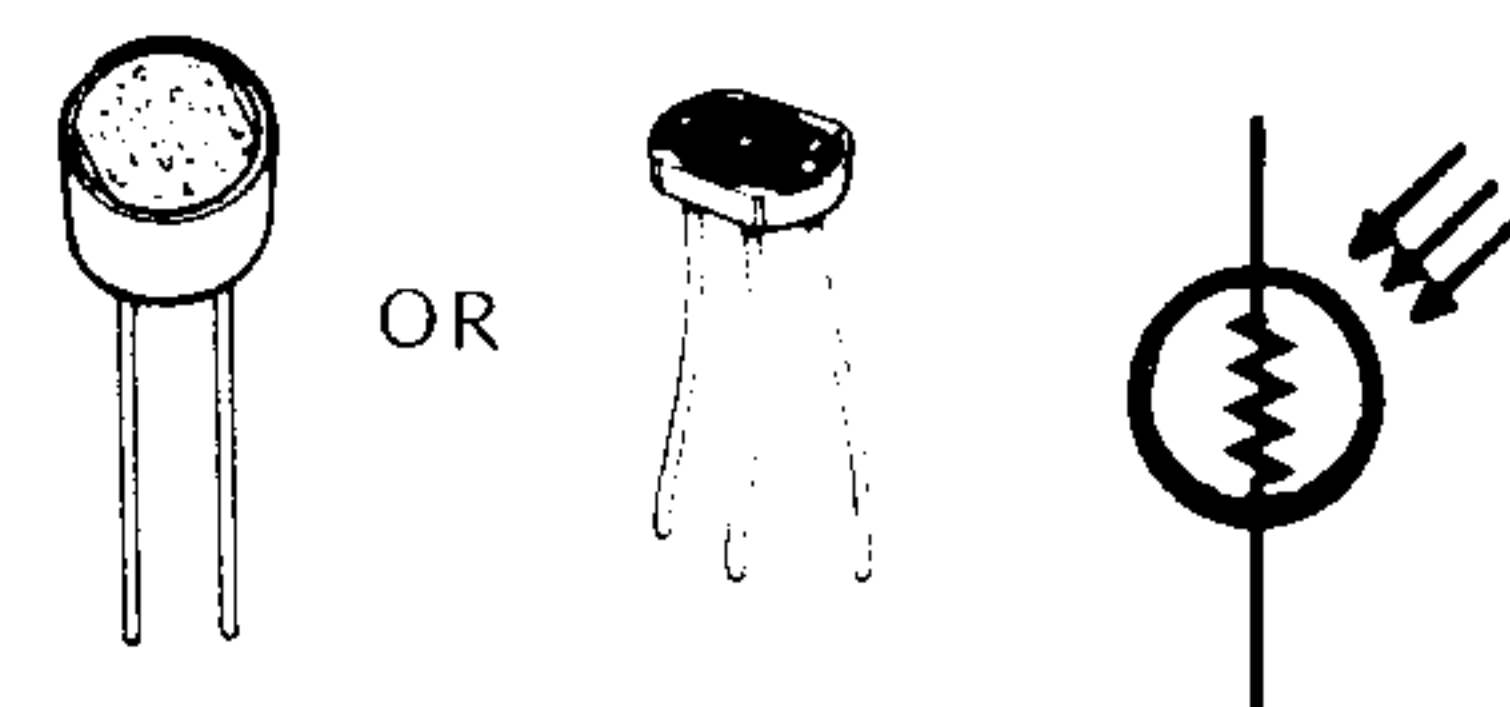

SPAGHETTI INSULATION:
(Pack of various sizes:
Dick Smith Cat. No. W-4040)

Called 'spaghetti' because it is hollow like spaghetti, this is an insulator which we use to slip over hook-up wire to give the wire more rigidity when used as 'probes'. Spaghetti insulation can also be used over tinned copper wire to insulate it if plastic covered wire is not available.



TRANSFORMER:
(Audio matching type;
8 ohms to 1k centre tapped.
Dick Smith Cat. No. M-0216)

The transformer transfers signal from one section of the circuit to another, while keeping the sections isolated from each other.

The transformer is polarised; working out the connections is easy because the '8 ohm' side has two leads, while the '1k' side has three leads. We ignore the centre lead on the three lead side.

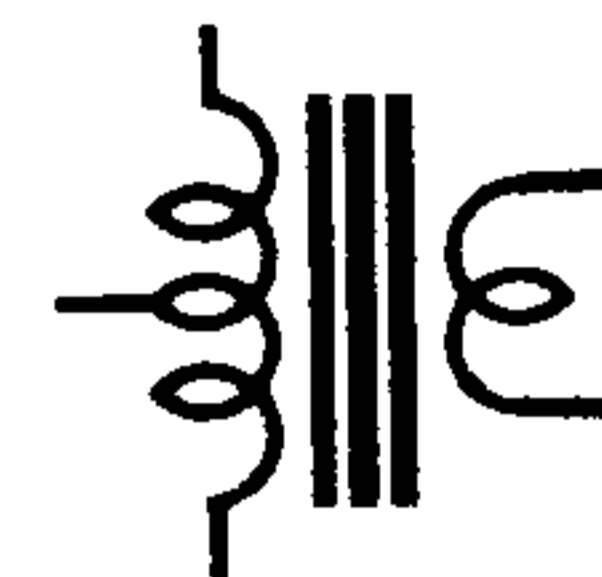
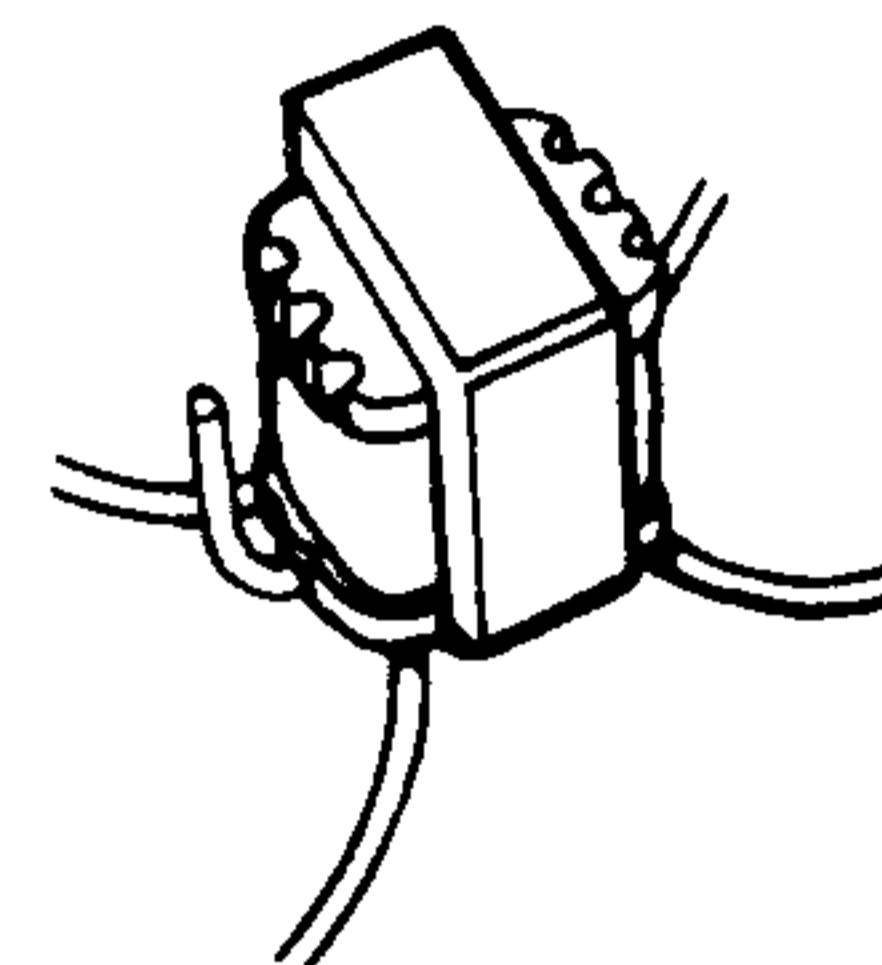

TRANSISTORS:

Transistors come in a huge variety of types, shapes and sizes. We use only two of these (luckily!); unfortunately they appear identical to each other so care must be taken!

Transistors are the modern day equivalent of the 'valve' or 'tube'. Because they do not need to heat themselves up to operate, they are more efficient.

There are three leads on a transistor; each one must be connected correctly for the transistor to operate. The three leads are called the **base**, abbreviated on circuits as 'B', the **collector**, abbreviated to 'C' and the **emitter**, abbreviated to 'E'. On some, but very few, transistors, there is a fourth lead, the shield (S), which is an electrostatic shield internally connected to minimise noise. If you come across a transistor with a shield lead, simply leave it disconnected unless the circuit specifically calls for its connection.

Transistors can act as very fast switches – by feeding in a certain amount of current to the base lead of the transistor, another (larger) current is made to flow into the collector (and out of the emitter). If we follow certain rules governing the operation of the transistor, we can feed in a varying current to the base, and obtain an enlarged replica of this current flowing through the collector. Thus the transistor is amplifying.

Our projects cover both types of operation: we use the transistor first as a switch, then later as an amplifier. As we mentioned, we use only two types of transistor, each having very similar characteristics but coming from two different 'families' of transistor – NPN and PNP:

'NPN' TRANSISTOR:
DS548 or similar
(Dick Smith Cat. No. Z-1308)

These must be connected the correct way around. Each lead is marked on the type of transistor specified. If you use a different transistor be careful! This transistor appears almost identical with the other type specified – so be careful!

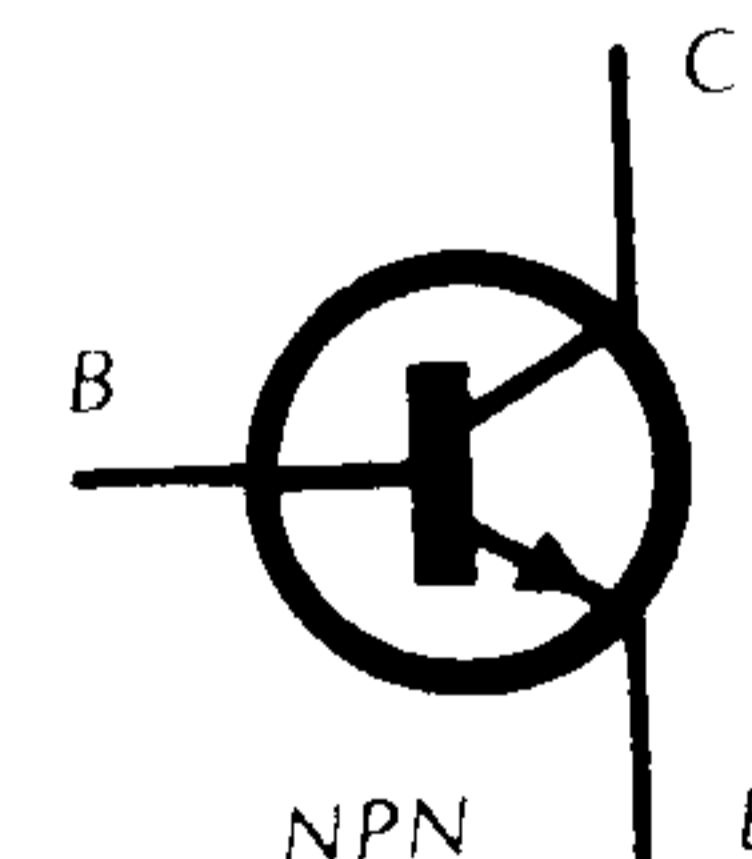

'PNP' TRANSISTOR:
DS558 or similar
(Dick Smith Cat. No. Z-1348)

Same comments apply as the NPN type! You can instantly recognise the type of transistor (NPN or PNP) by the fact that the arrow on the emitter lead points outwards on an NPN, inwards on a PNP. The transistor may be drawn upside down, back to front, any which way on the circuit – but the arrows will still point out for an NPN, in for PNP.

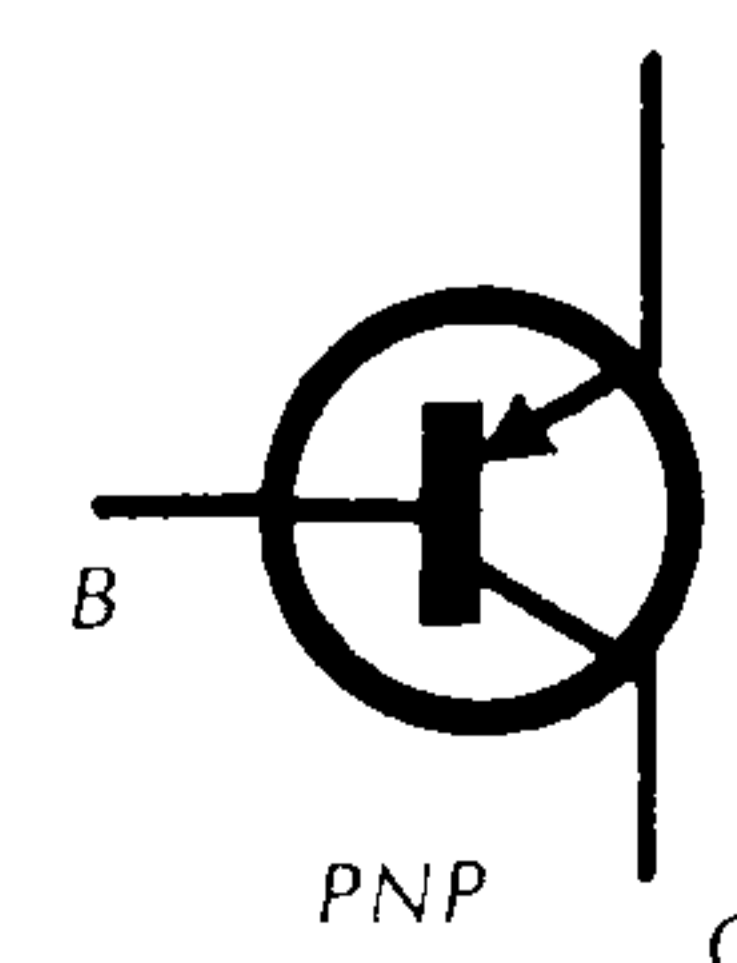

Component marking codes . . .

Resistors:

Resistors are often so small it is impractical to try to print each one with its value. So they are marked with a code printed on them in bands of coloured paint. These bands give us the resistor's value.

The colours and their values:

BLACK	0	BLUE	6
BROWN	1	VIOLET	7
RED	2	GREY	8
ORANGE	3	WHITE	9
YELLOW	4	GOLD	x0.1
GREEN	5	SILVER	x0.01

How to read them:

Start with the band closest to one end or, if it is difficult to work out, the band furthest away from the gold or silver band. Take the resistor above: the first band is orange – from the table this means three. The second band is white – 9. The third band is brown – 1, so we add one zero to the first two figures: 3, 9 and 0 – or 390 ohms.

The fourth, or tolerance band, is silver: 10%. Therefore, the resistor is 390 ohms, 10% tolerance (or somewhere between 390 -10% and 390+10%, or 351 and 429 ohms). This is more than adequate for most circuit requirements. Resistors are available which are 'spot on' in value – however, these are not required in most circuits, and are often very, very expensive.

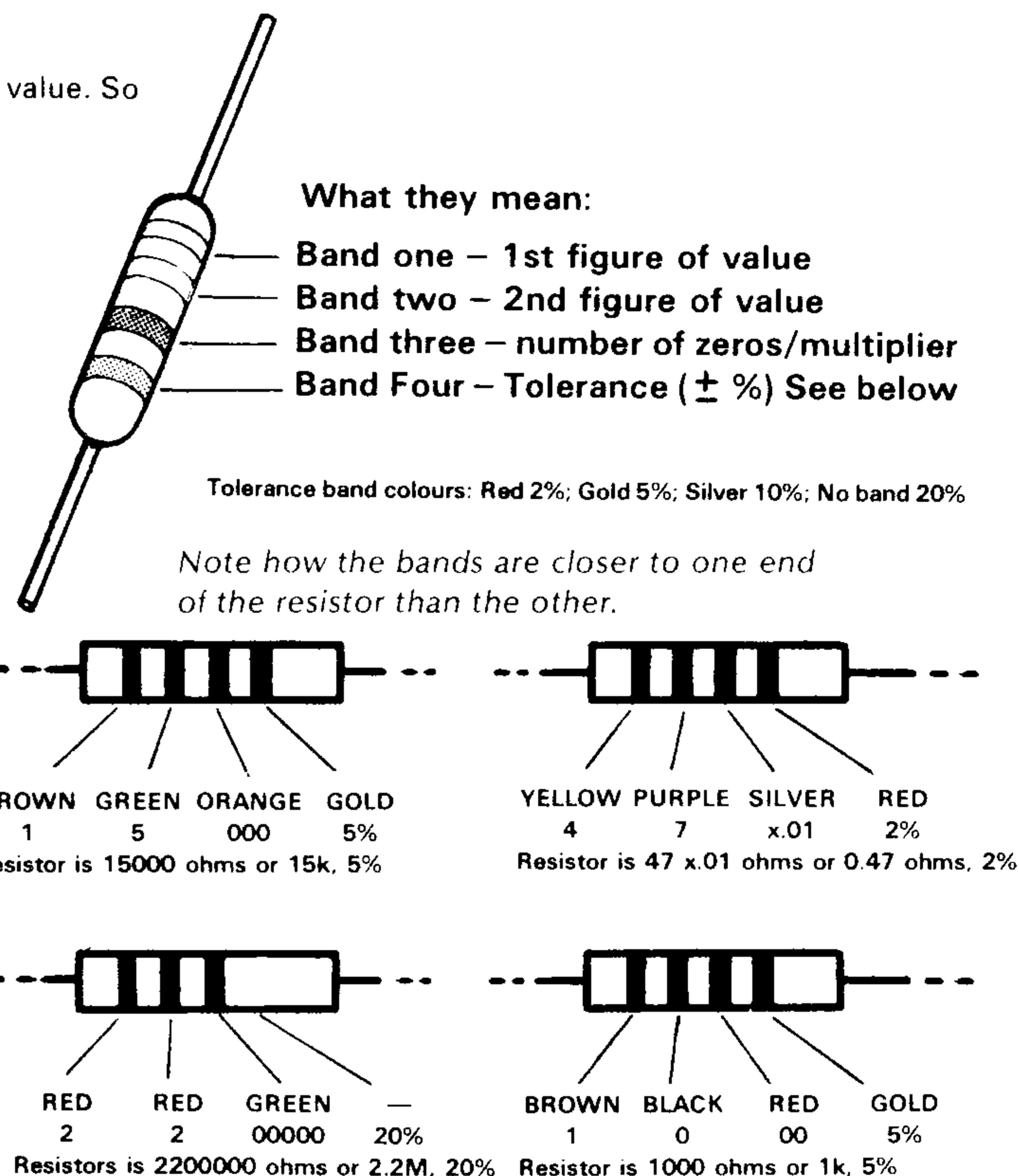

Capacitors:

Most capacitors will have their value printed on them. However, there are a number of capacitor manufacturers who use the 'IEC' code. This code is a numerical code, but works in a similar way to the resistor colour code: two figures followed by a multiplier. There is often a single letter code showing tolerance.

The code is worked out in picofarads, so you may have to use the appropriate metric multiplier.

A capacitor may have a code '104K'. This decodes as follows – 0.1 uF, 10%. The first two figures give us 10, the third figure gives us 0000, and the letter 10%. Therefore, the capacitor is 10 0000pF, 10%. We normally express this as 0.1 uF – only capacitors with a value below .001 uF are expressed in picofarads.

There may be a further figure marked – this would be the voltage rating of the capacitor (the maximum voltage at which you can use that capacitor.)

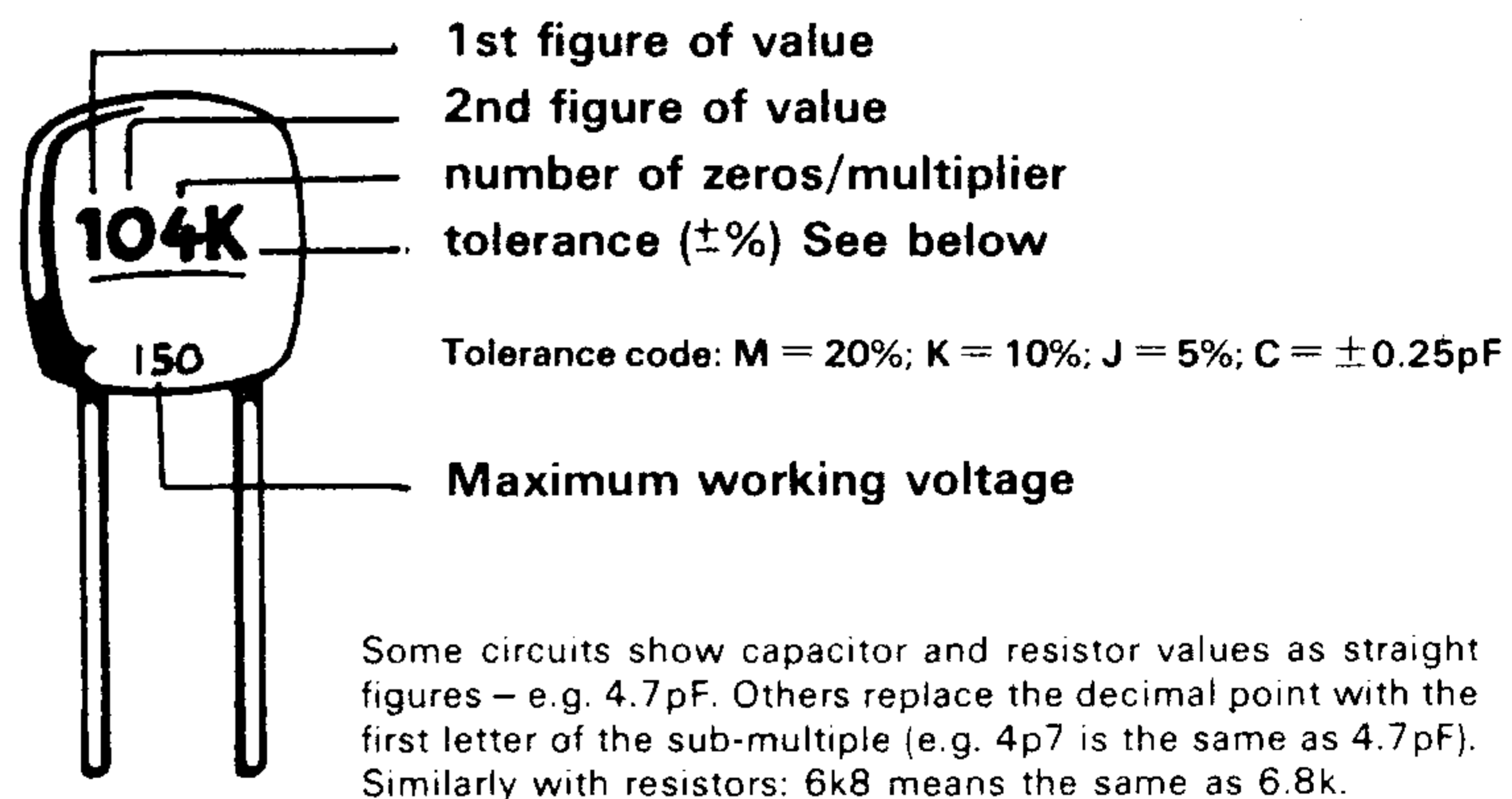

Metric units and conversions:

Throughout this book and, indeed, most electronics publications, metric multipliers are used to simplify and shorten component values, etc.

For example, capacitance is measured in Farads – but the Farad is a huge unit of measurement, much too large to be of any use in expressing capacitor values. So we use a suitable metric sub-multiple to save a lot of figures. Instead of saying, for example, .000000000001 Farads we say 1 pico Farad (1pF).

We have used only micro Farads (uF) and pico Farads (pF) in this book; however, some publications use the abbreviation nano Farad (nF) so you should get to know these eventually, too.

Abbreviation	Means	Multiply unit by	Or
p	pico	.000000000001	10 ⁻¹²
n	nano	.000000001	10 ⁻⁹
u	micro	.000001	10 ⁻⁶
m	milli	.001	10 ⁻³
—	UNIT	1	10 ⁰
k	kilo	1 000	10 ³
M	mega	1 000 000	10 ⁶

1000 pico units = 1 nano unit 1000 nanounits = 1 micro unit
 1000 micro units = 1 milli unit 1000 milli units = 1 unit
 1000 units = 1 kilo unit 1000 kilo units = 1 mega unit

If you've never built an electronic project before, there are a few things you should know in order to make your projects a success. Follow these tips and they'll work – first time!

- (1) As we mentioned previously, all components in these projects are held in position by self-tapping screws and washers. The accompanying diagram shows how this is done. Components and connecting wires should be securely fastened underneath the washer, but do not over-tighten as you may strip the hole in the base-board.

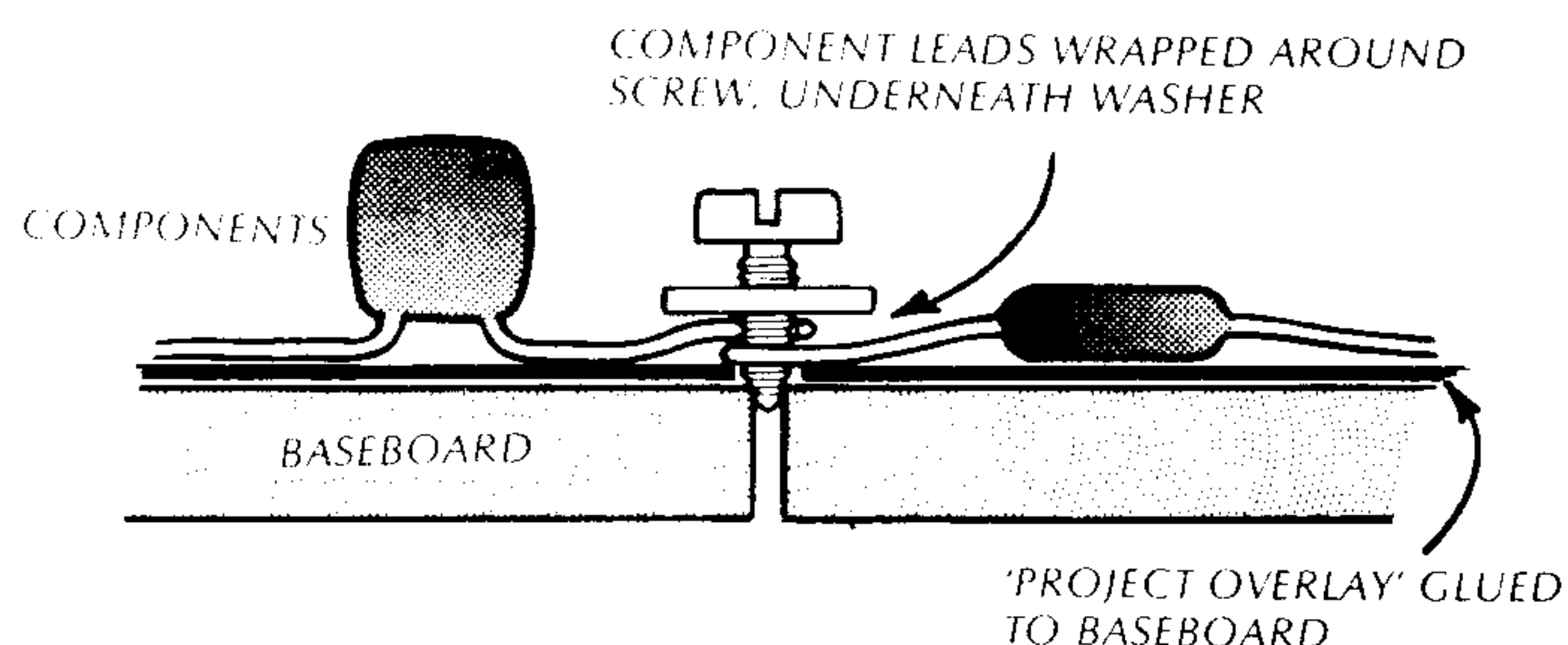

- (2) The reason you have to have the holes in the correct position is that any inaccuracy could result in two washers touching each other and 'short circuiting'. Some of the holes, especially those 1cm apart, do not allow any margin for error.
- (3) It is best to wind the component leads around the screws in a clockwise direction, wherever possible, as this will prevent the leads from being forced out as you tighten the screw. A bit of juggling may be required where a number of component leads & links join under one screw.
- (4) Make sure the component leads are not pulled too tight as the screw is tightened, as some components may snap apart under tension. It is always best to leave a small amount of 'slack' in the lead. Also ensure that you do not have any of the component itself under the washer, as the components are easily damaged.
- (5) Be careful when you put the screws into the baseboard. It helps if you first drill a small 'pilot hole' to ensure the screws go in where you want them to. For the No. 4 self-tapping screws we recommend, the drill should be approximately 2.5mm (or 3/32" or No. 41). If a drill is not available, an alternative method is to start the hole with a hammer and a nail.
- (6) Don't bend the component leads too much, as they may suffer metal fatigue and break off. Also, don't bend the leads too close to the component itself – especially transistor leads.
- (7) If you cut off some of a component's leads to make it fit better, you may cut off the way the component's polarity is marked. This is especially true of Light Emitting Diodes (LEDs) – the negative (cathode or 'K') lead is normally shorter than the anode lead. If you do cut the leads of a LED, remember which one was which!

- (8) It is always better to mount solid state components (transistors, diodes, LEDs, integrated circuits, etc) last. Start construction with the wire links, followed by resistors, capacitors, etc, and last of all the solid state components. Always check polarities of components as you mount them.
- (9) If you run out of wire for your wire links, always remember that you can use the ends of component leads as links. So if you cut, or 'crop' any component leads, keep the 'croppings' as links for later use.
- (10) If you want to run a short insulated link over part of one of your boards and have no insulated wire, you can use ordinary tinned copper wire (such as from a resistor cropping) and insulate it with a plastic drinking straw – or anything similar that will not conduct electricity. You can even use the thicker type of plastic straws instead of the spaghetti insulation we use to give our probes rigidity.

Collect all the components in a dish, plate, etc, before you start a project. You might find that a block of styrene foam (similar to that used in floats, etc) is a handy aid. Component leads can be pushed into it to hold them ready for later use.

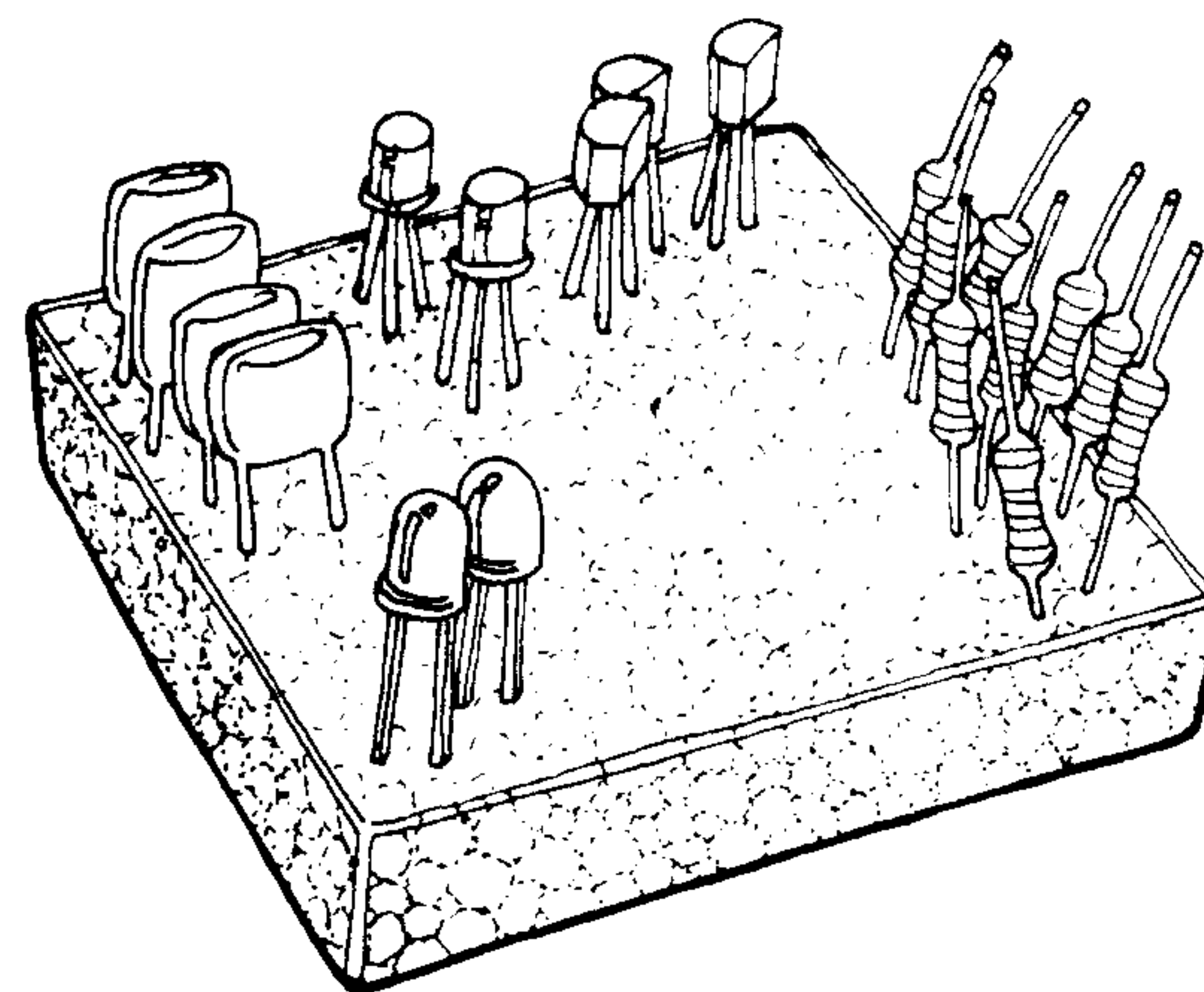

- (11) Regardless of what you might imagine about electronic circuits, you don't always need the component called for to get the circuit to work! For example, if a circuit specifies a 1.2k resistor, and all you have is a 1k or a 1.5k, try it – it will probably work! The reason for this is most circuits are designed with a certain tolerance in mind – the component doesn't always have to be 'spot on' in value for it to work quite happily!
- Even such things as transistors may often be replaced with a similar type. So if you have a different transistor to that specified in the circuits in this book, try it: as long as it is of the same 'family', (that is, NPN or PNP) it could well work.

- (12) Most electronics hobbyists have what is called a 'junk box' in which goes not junk, but spare components. So when a circuit comes along the hobbyist can go through his junk box and find components which might be close enough in value to work.

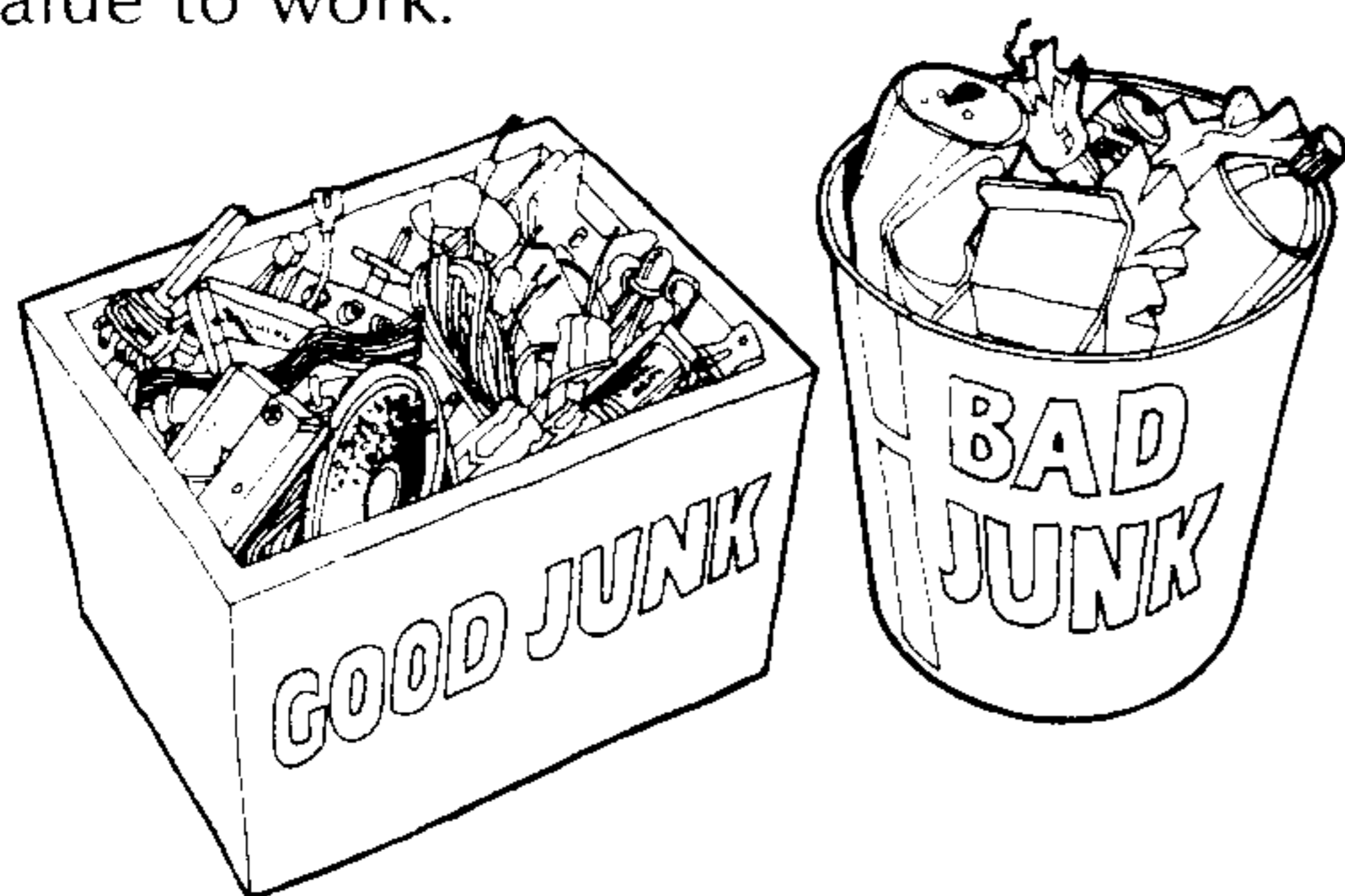

- (13) Connection of the wires to your loudspeaker should be done carefully to avoid problems. Remove about 4cm of insulation from the wire, and twist the strands together in your fingers so they form one solid conductor. Loop this through the hole in the speaker terminal, and tie as secure a knot as you can. Any remaining wire can be twisted around the terminal. Repeat for the other speaker terminal.

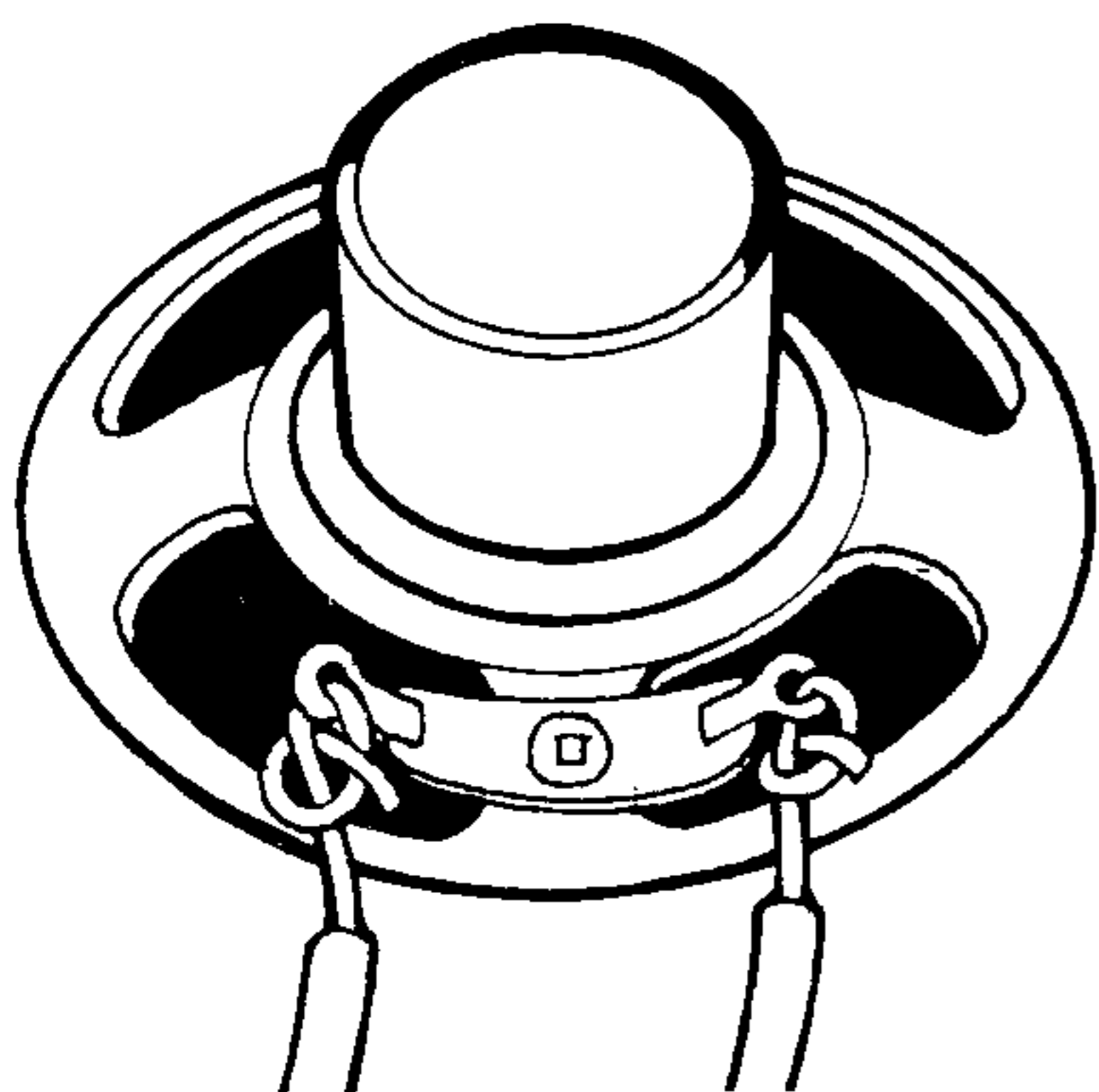

- (14) Before you connect your battery check, and then double check all your components and wiring. If your project does not work, the chances are you have an incorrect component or connection. It is fairly difficult to damage components in these circuits, so there is probably an error.

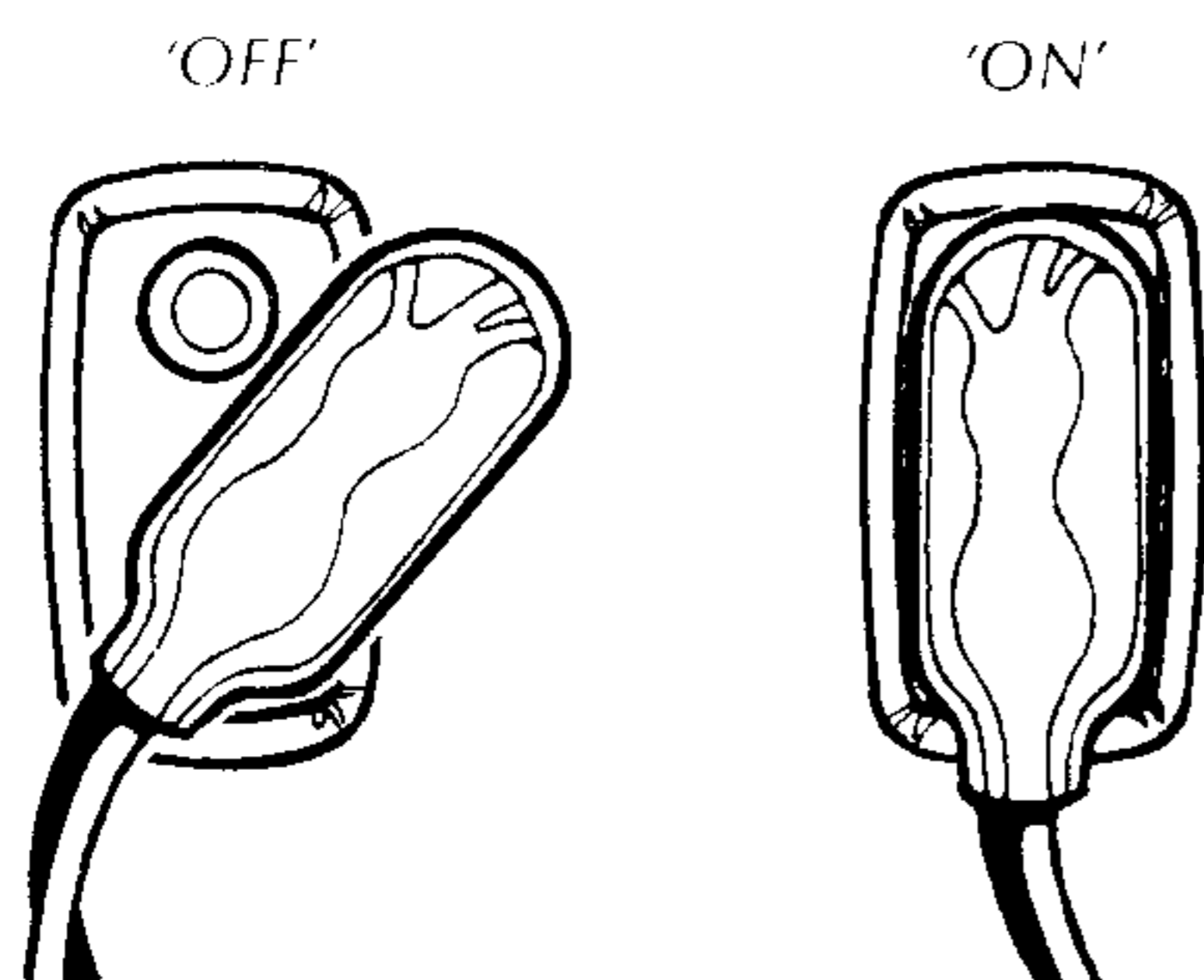

- (15) A simple form of on/off switch can be made by using the battery clip. Simply clip one side only (it doesn't matter which) of the battery into the battery clip and twist the battery so that it touches the other clip to turn 'on' or does not touch it to turn 'off'. (See diagram).

Overleaf, you'll find the first of our twenty easy-to-build projects. Before you start construction, though, you may care to assemble a complete kit of parts: so you'll be able to make any project in the book whenever you like!

We have divided the projects into two groups: one to ten, and eleven to twenty. The first group has relatively simple and inexpensive components, while the latter group has slightly more specialised components.

Even so, we imagine that no project in this book should cost more than about \$10.00 to build – and most will cost a lot less!

PROJECTS ONE THROUGH TEN:

Resistors: 1 x 47 ohm; 1 x 68 ohm; 2 x 100 ohm; 1 x 390 ohm; 2 x 1.2k; 1 x 1.5k; 4 x 2.2k; 2 x 3.3k; 1 x 3.9k; 1 x 4.7k; 2 x 10k; 2 x 33k; 1 x 47k; 2 x 100k

Light dependent resistor: 1 x ORP12

Capacitors: 2 x .01uF greencap; 2 x 0.1uF greencap; 1 x 10uF 16 volt electrolytic; 2 x 100uF 10 volt electrolytic

Transistors: 2 x DS548 (NPN); 1 x DS558 (PNP)

Diodes: 1 x 1N4001

Light Emitting Diodes: 2 x TIL220R

Miscellaneous: 1 x 8 ohm speaker; 1 x 9V battery clip; 4 x 30cm lengths of insulated hook-up wire; 1 x 50cm length of tinned copper wire; 28 x No. 4 12mm self-tapping screws; 28 x 4BA washers; 1 particle board 12cm x 10cm. (Note: Morse key and battery are not included in above list).

PROJECTS ELEVEN THROUGH TWENTY:

Resistors: 1 x 470k

Potentiometers: 1 x 500k

Semiconductors: 1 x OA91 signal diode; 1 x ZN414 integrated circuit.

Capacitors:

1 x 10pF disc ceramic; 2 x 0.001uF disc ceramic; 2 x 0.01uF disc ceramic; 1 x 0.047uF disc ceramic; 1 x 0.1uF disc ceramic; 1 x 0.047uF greencap; 2 x 10uF 16 volt electrolytics; 1 x 60 to 160pF variable

Miscellaneous: 1 x Ferrite rod aerial; 1 x crystal earphone; 1 x audio matching transformer, 8 ohm to 1k ohm; 1 x 70cm length insulated hookup wire

The above components are very common and may be obtained from virtually any electronics parts supplier. However, in order to assist you make these projects successfully and at minimum cost, Dick Smith Electronics have assembled two 'Fun Way Project Kits' from each of the above lists. The price of these kits is far below the cost of buying the components individually. For more details, refer to the inside front cover of this book.

A continuity indicator

This project is about as simple as one could imagine: just a couple of components and a battery! Many components and electrical circuits can be checked for faults by using a circuit such as this.

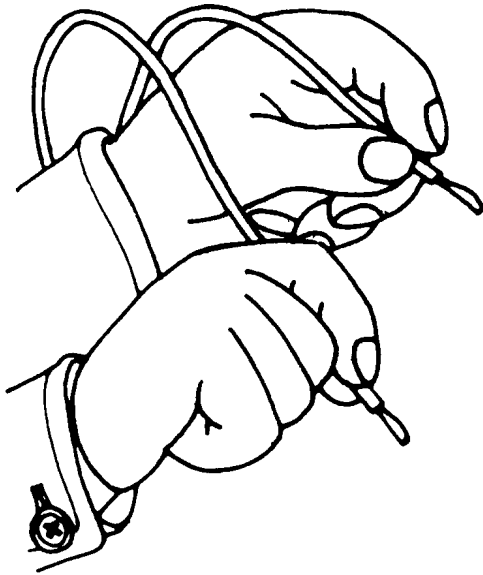

As its name implies, this is simply a device for checking that there is a continuous electrical circuit between two points. While it is a simple device in itself, its uses are many and varied.

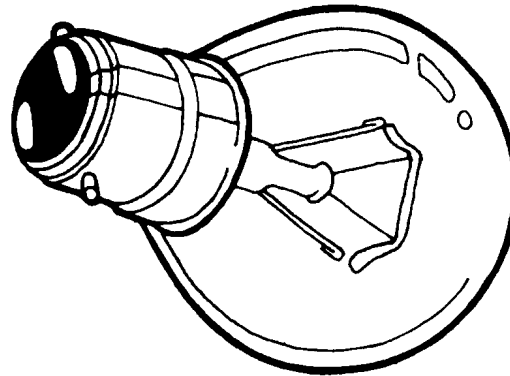

Resistors:

One 390 Ohm (orange - white - brown)

Diodes:

One light emitting diode (LED)

One protection diode (1N4001 or similar).*

Miscellaneous:

One 9V battery & battery clip

Two lengths of hookup wire, 25cm long

Two lengths of 'spaghetti' insulation, 12cm long

3 lengths of tinned copper wire

8 self tapping screws & washers

Baseboard & project overlay for project No. 1.

* The protection diode included in all but one of these projects is purely to prevent damage to components should the battery be accidentally reversed. If you wish to save the cost of this diode, it can be replaced by a wire link. But note there will be no protection should you reverse the battery connections. Be careful!

- (1) Cut out the project overlay for project No. 1 at the back of this book and glue it to your baseboard.
- (2) Mount the wire links first, followed by the resistor, the protection diode (*) and finally the LED. Developing this order of construction now will help you later on if and when you begin to solder delicate components in more complex projects.
- (3) Check that all your components are properly screwed down, and that the two components which are polarity conscious (the diode and the LED) are indeed the correct way around.
- (4) The 'probes' are made by removing 1cm of insulation from each end of the two pieces of

(4) *cont.*

hookup wire, and connecting one end of each to the points marked 'probes' on the board. To make them slightly stiffer, slip a length of spaghetti insulation over the end of each wire so that just the bared conductors are showing.

- (5) Connect the battery to the clip. If all is well, you should see absolutely nothing happen!
- (6) Now try touching the probes together. The LED should light brightly. If so, your continuity indicator is ready for use. If not, go over your work, checking each component is correct and is tightened down.

At right is a graphical representation of the way the various components inter-connect with each other. As you will note, this shows the 'symbol' for each component, rather than the component itself.

This is called a 'circuit diagram' or 'schematic diagram'; compare it with the pictorial diagram below.

Some later circuits may differ slightly in layout from the pictorial drawing to comply with good circuit drafting practice; this circuit, being so simple, is virtually identical to the pictorial below.

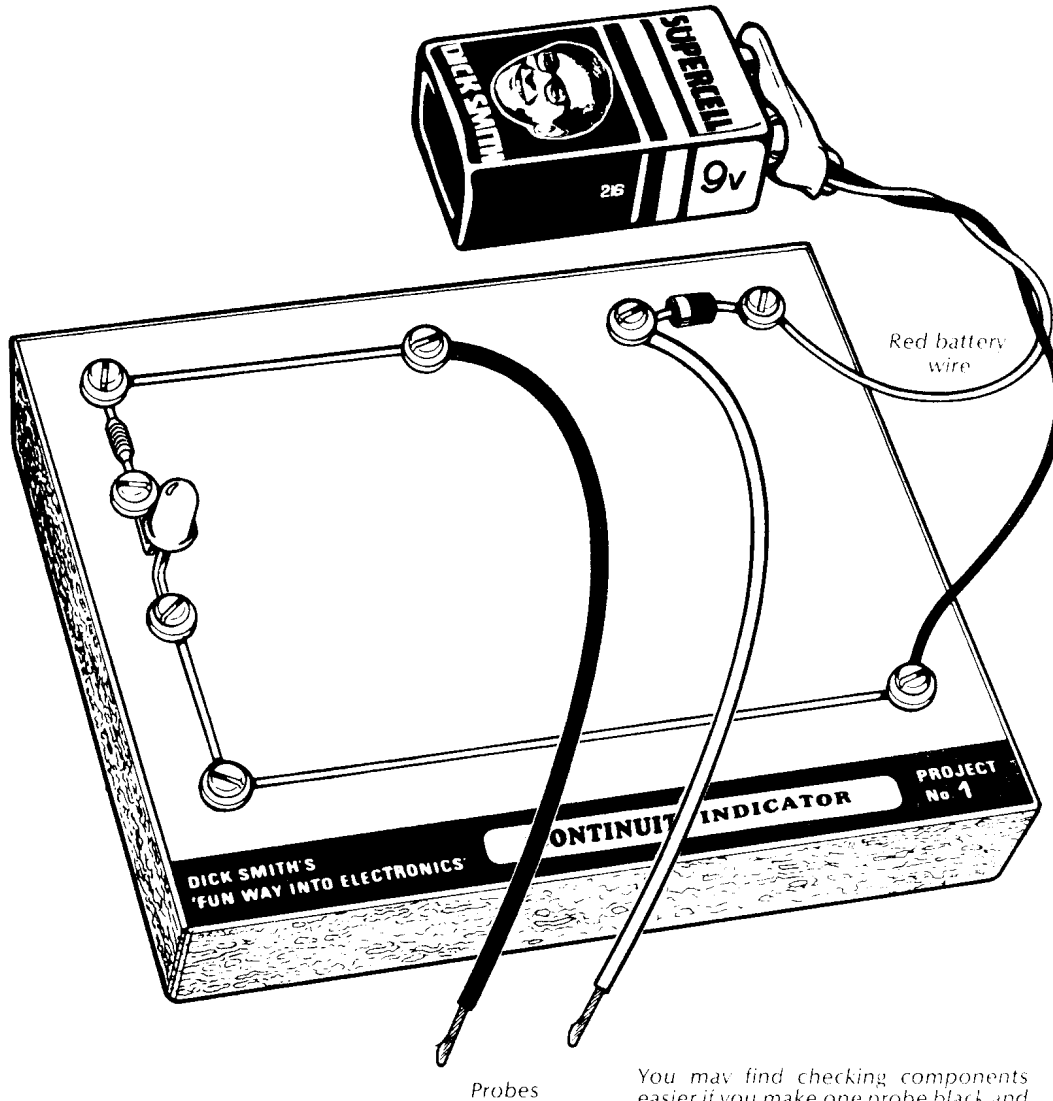
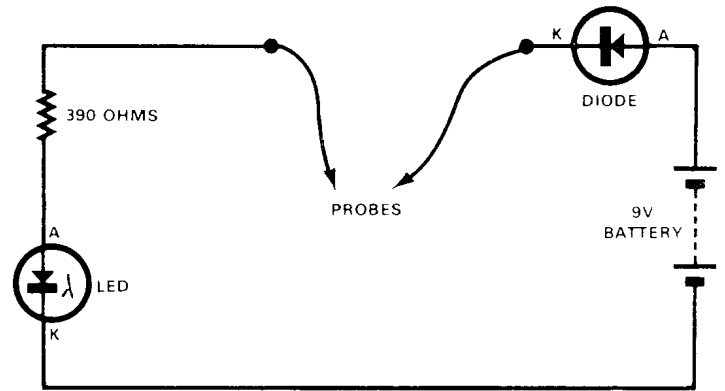

Black battery wire

You will find the continuity indicator very handy for circuit checking, especially the connections between screws and components. If, however, you want to test a component itself, it is important to remember that **you must first remove the component from the circuit**, otherwise you could get a false result from the other components in the circuit which are connected to it.

You may find checking components easier if you make one probe black and one red - then you will be able to check polarised components properly. Follow the colours shown on the layout.

The continuity indicator basically consists of a power source (the battery) and an indicator (the LED). The circuit between the battery and the LED is broken, and probes are connected to each side of the 'break'. The circuit is completed via these probes. We can either touch them together ('short' them) or connect them via an external circuit or component that we wish to check.

If the circuit is completed in this way, current flows from the battery positive through the probes, the LED

and back to the battery negative end. Because a LED can easily be damaged if too much current is allowed to flow through it, our circuit also includes a low-value resistor to limit this current to a safe amount when the probes are shorted.

The brightness of the LED indicates how much current is flowing through it: with the probes shorted, it glows very brightly; with some resistance between the probes, less current flows and the LED glows less brightly.

Connect a 1.2k resistor between the probe tips as shown in figure 4. How bright is the LED?

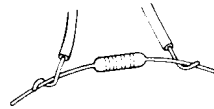

Figure 4

Now connect another 1.2k in **series** with the first (see figure 5) – what happened to the LED brightness?

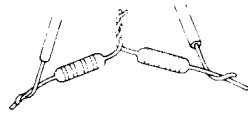

Figure 5

Connect a third 1.2k in series (fig. 6). What has happened now?

The LED will keep getting dimmer and dimmer as you add more resistors to the chain. This is because the overall resistance **increases** when you add resistors **in series**. Two 1.2k in series equals 2.4k. 3 equals 3.6k And so on.

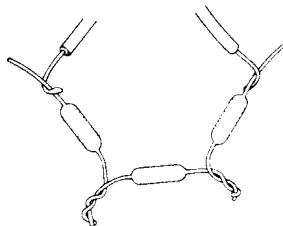

Figure 6

Now something different: Revert to the one resistor as shown in figure 4. Add a second 1.2k resistor in **parallel** (as shown in figure 7. Notice the LED?



Figure 7

Try a third 1.2k. And a fourth (see figure 8)

Each time you add another resistor, the LED will get brighter (up to a point!) because adding resistors in parallel **decreases** resistance. Two 1.2k resistors in parallel equals 600 ohms. Three 400 ohms, four 300 ohms, and so on.

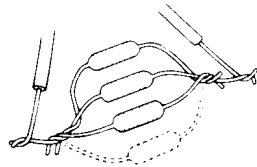

Figure 8

Because the resistance gets lower with each resistor added, the more current can flow. Thus the LED is brighter.

Try, if you like, connecting a potentiometer (as used in later projects) to the probes (one probe to the centre lug on the pot, the other probe to either of the outside lugs). You should be able to make the LED as bright or as dim as you want it to be.

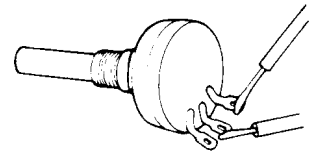

Figure 9

Or try a light dependent resistor. Once again you should be able to vary the LED brightness as you wish, by changing the amount of light falling on the LDR (more about this device in project 4!)

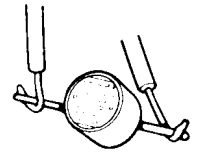

Figure 10

You can test power diodes, signal diodes or light emitting diodes with the continuity indicator. You should find that connected to the probes one way, they will light the LED, but reverse the connections and the LED should not light up.

Connected this way, the LED should not glow.

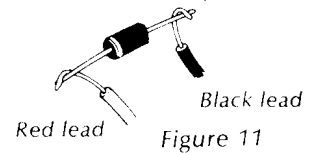

Figure 11

Connected this way, the LED should glow.

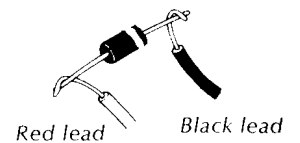

Figure 12

If you find that neither or both ways light the LED, the diode under test is probably damaged.

It is rather more difficult to test capacitors with a continuity indicator. Most electrolytic capacitors can be checked, however smaller types such as greencaps and disc ceramics can not easily be checked, except to see if they are internally shorted.

Connect a 100uF electrolytic capacitor across the probes as shown in figure 13 (note the polarity!). As the capacitor energy builds up ('charges') the LED will glow. This shows current is flowing from the battery into the capacitor. As the capacitor charges, the current becomes less and less, and the LED brightness

Always connect the black test lead to the negative end of the electrolytic capacitor.

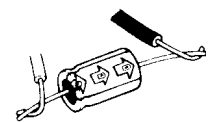

Figure 13

decreases. When the capacitor is fully charged, current ceases and the LED fades out.

Depending on the capacitor, the LED glow might last for a few seconds, or flash very briefly.

Try a 10uF electrolytic. Being a smaller capacitance it takes a shorter time to reach its fully charged state. So the flash is briefer.

If you miss the flash, you can see it again by discharging the capacitor. Short its leads together, and try again. But watch for it this time!

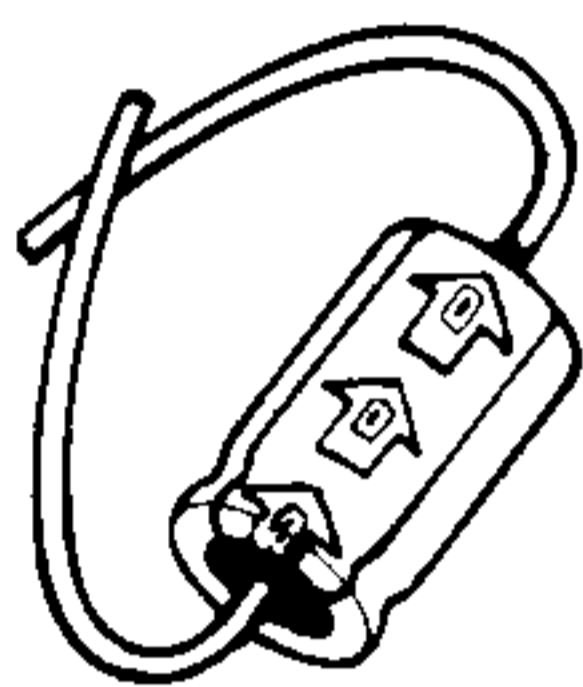

Figure 14

If you connect a greencap, disc capacitor, etc across the probes, the LED flash will be so brief you probably won't see it at all. If you do see a long flash, or the LED stays on, the capacitor is almost certainly damaged.

Before we finish with capacitors, you may be interested to know that connecting capacitors in series does **not** increase capacitance, but actually decreases it! Capacitors behave exactly opposite to resistors: In series the total capacitance decreases, and in parallel the total capacitance will increase.

When the probes are connected to a speaker or earphone, a 'click' sound will be heard, indicating they are probably functioning properly. However, the LED will only light when the speaker is connected, as the earphone has a very high resistance.

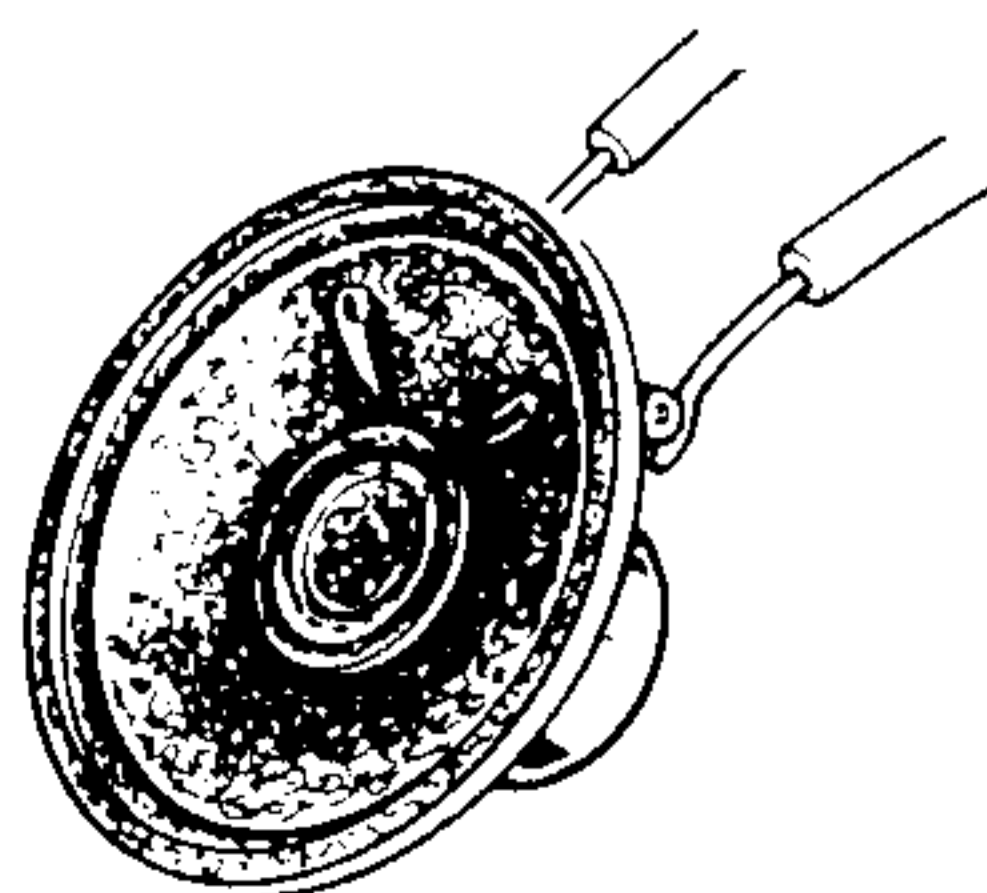

Figure 15

You will notice on the ferrite rod aerial there are two coils. Normally they are composed of different coloured wire (for example, one may be red wire and the other pink wire) but in any case, you can recognise them easily because one coil is much wider than the other. Connecting the probes to two wires from the same coil should light the LED.

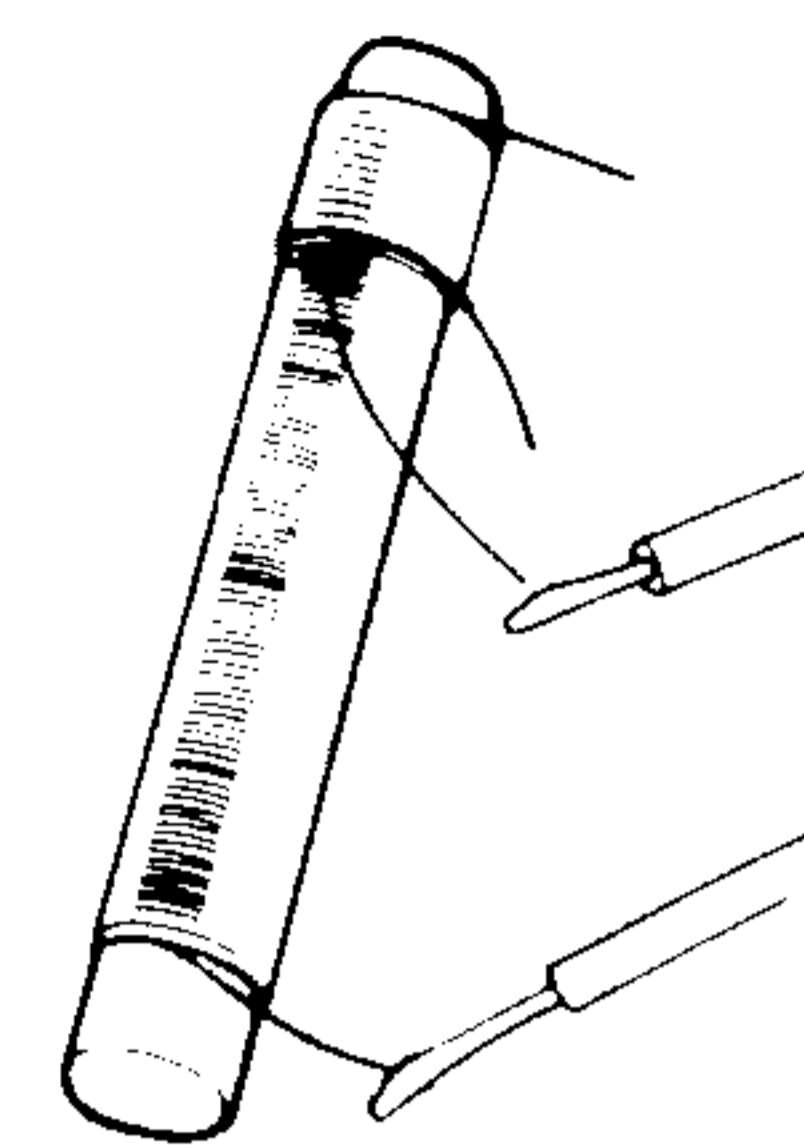

Figure 16

If not, there could be a break in the very fine wire of the coil; or it could mean that the very thin coat of insulation on the wire is preventing contact with the probes. This must be very carefully scraped off with a sharp blade.

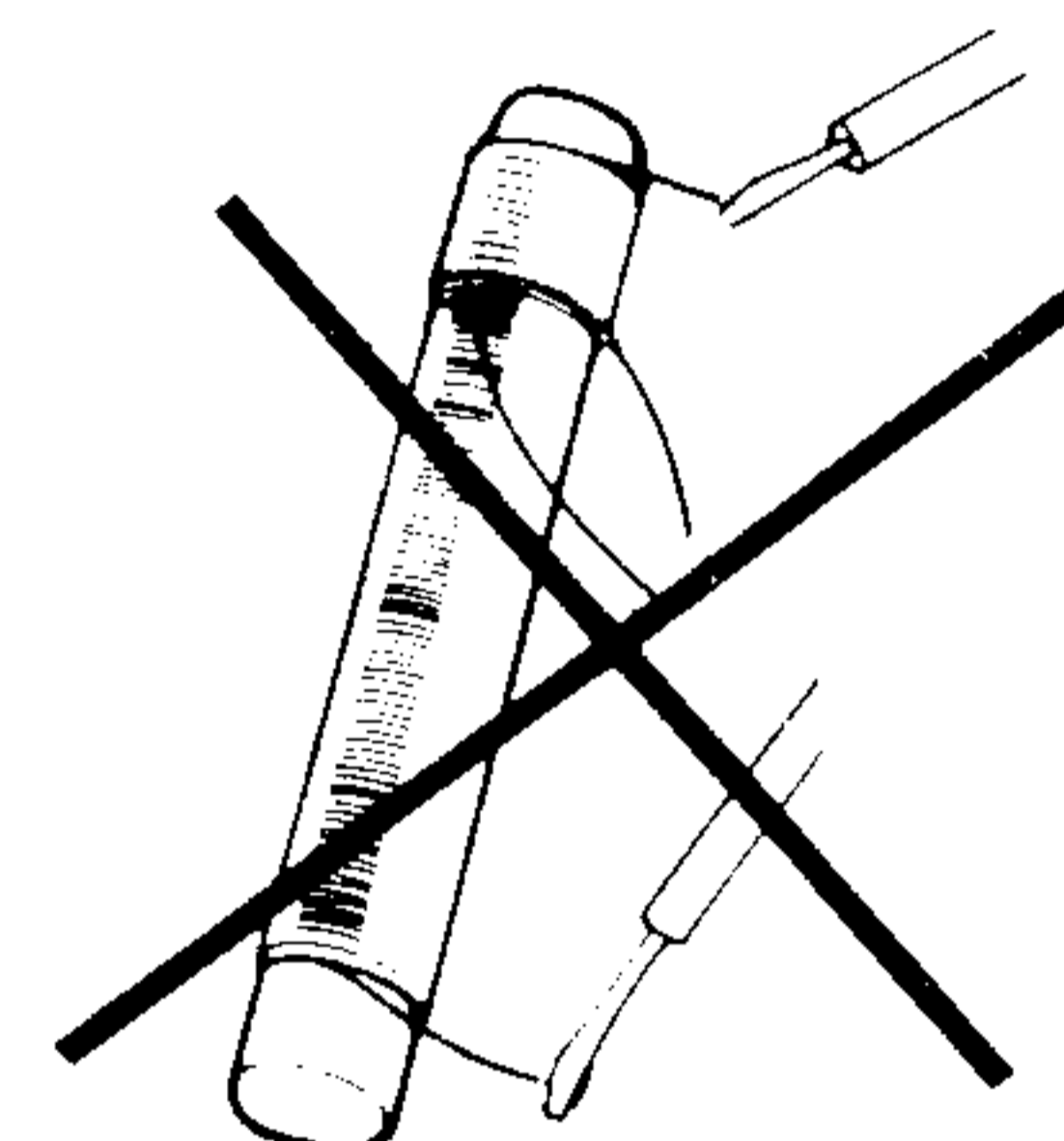

Figure 17

If you connect the probes to one wire from one coil and one wire from another coil, the LED should **not** light.

Likewise, the transformer can be checked. You will note there are two leads on one side and three on the other. Connection between the two leads, or any two of the three, should light the LED. If it doesn't, your transformer may be faulty.

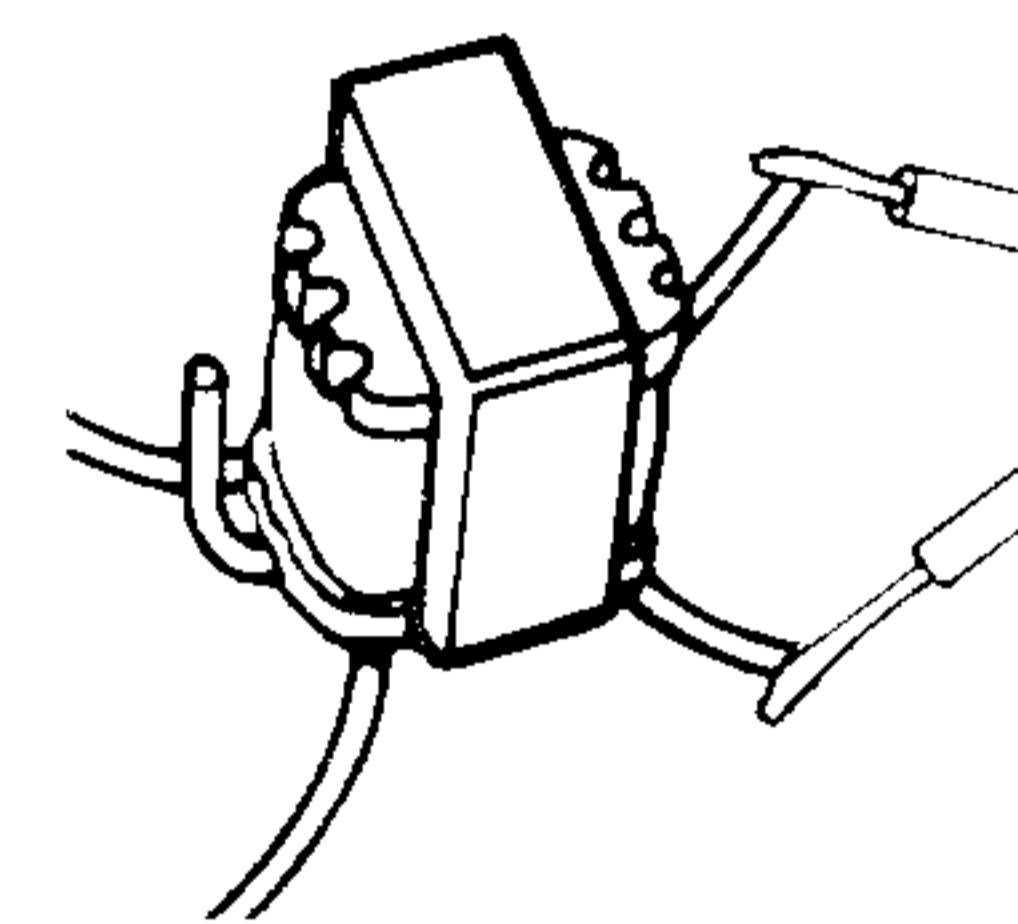

Figure 18

Again, the LED should not light if one of the two leads and one of the three leads are connected to the probes.

A transistor tester

Here's a project that will not only show you how transistors work, it will also let you check any of the transistors you'll use in the projects in this book.

While the basic circuit has been described to suit NPN transistors (see 'transistors' in the section on components at the start of this book); the circuit is very easily modified to check PNP transistors.

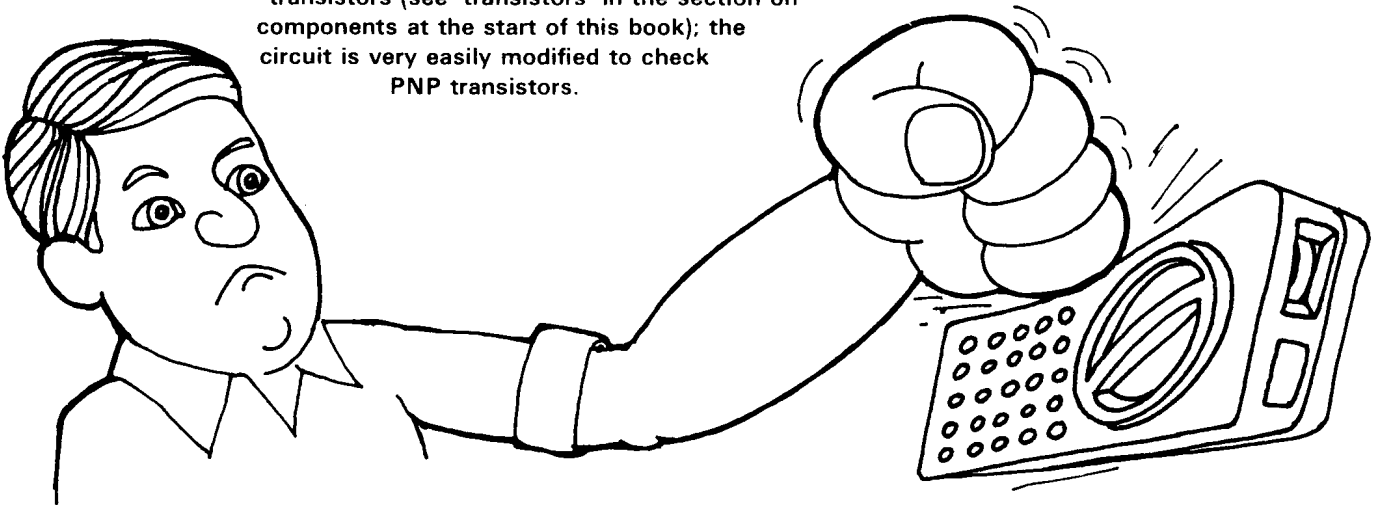

- Resistors:** One 390 ohms (orange - white - brown)
One 10k ohms (brown - black - orange)
- Diodes:** Two light emitting diodes (LEDs)
One protection diode (1N4001 or similar).
- Transistors:** One NPN type DS548 or similar
One PNP type DS558 or similar

- Miscellaneous:** One 9 volt battery and battery clip
3 lengths of tinned copper wire
11 self-tapping screws with washers
Baseboard & project overlay No. 2

- (1) Cut out the project overlay for project No. 2 at the back of this book and glue it to your baseboard.
- (2) Mount the wire links first, followed by the resistors, the protection diode, the LEDs and finally the transistor.
- (3) We need only the NPN transistor (DS548 or similar) at the moment. Leave the other transistor until later.
- (4) Connect the battery to the clip. Both LEDs should be lit.
- (5) You should notice that the LED connected to the transistor's collector is glowing much more brightly than the LED connected to the base. If so, proceed on. If not, check your wiring and polarities of LEDs, etc.

This is the circuit for checking 'NPN' transistors. The checks are shown on the next page.

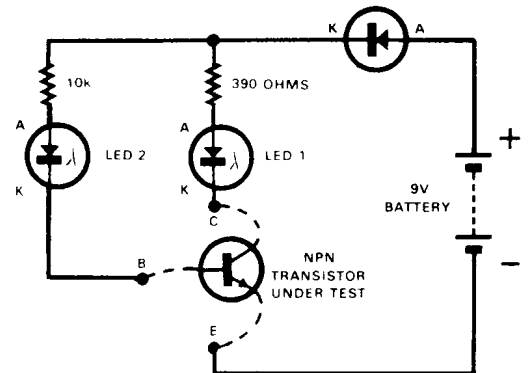

The 'PNP' circuit: notice the differences? The diode, LEDs, transistor and battery are all 'turned around'.

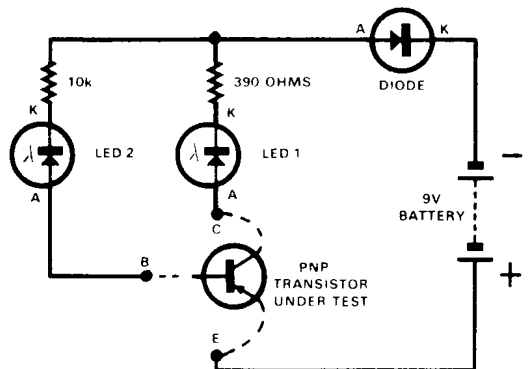

The board layout below shows the components connected for the NPN version. Follow the instructions in the text for PNP transistors.

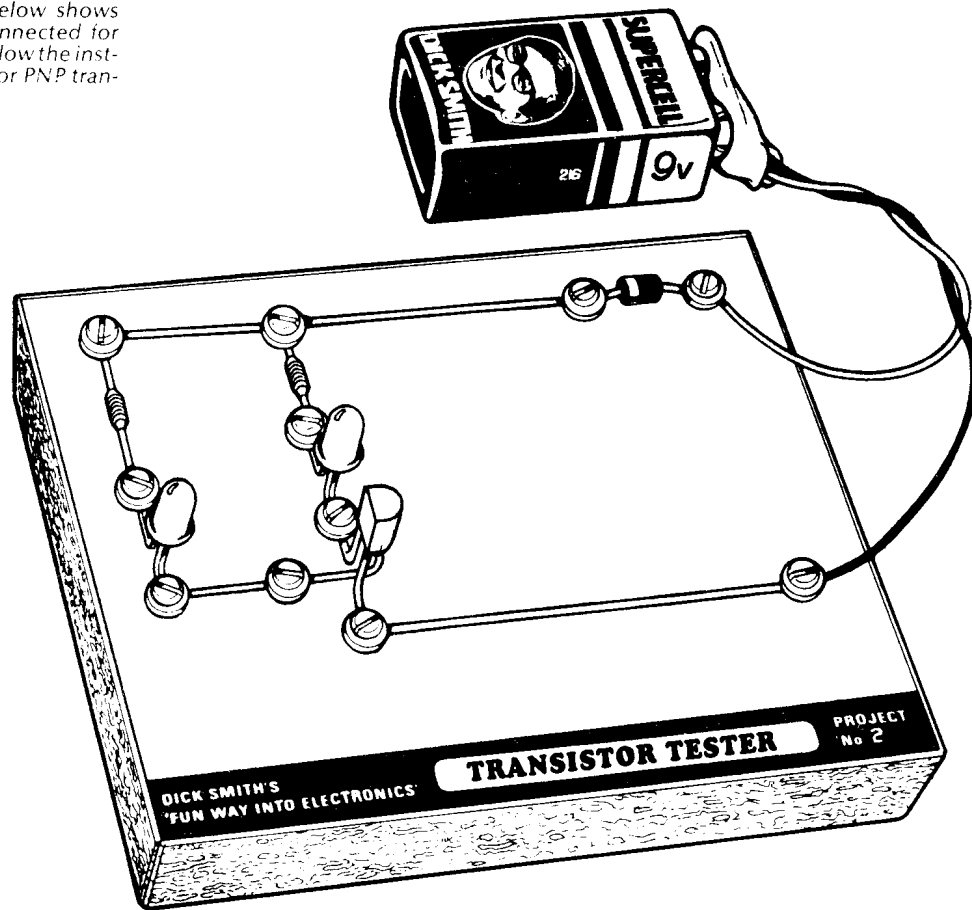

The transistor is connected as an amplifier with a LED connected to both the base and collector to show where, and how much, current is flowing in the circuit.

As explained in the section on components, a small current flowing through the base of a transistor causes a much larger current to flow through the collector.

In our circuit, current flows from the battery positive terminal through the protection diode, 10k resistor and LED, through the base/emitter of the transistor and back to the negative battery terminal.

This causes a larger current to flow, via the LED and 390 ohm resistor, through the collector/emitter of the transistor.

The LEDs monitor this current – and because the current through the base is much smaller than the

current through the collector, the base LED glows less brightly than does the collector LED.

The fact that these LEDs **do** glow at different brightness levels is one of the two tests we can make to check the transistor. The different brightness levels indicate that the transistor is amplifying.

The second test simply involves disconnecting the wire link from between the base and the LED to check that the transistor is not 'leaking'. When you disconnect the wire link, obviously no current can flow into the base, so the transistor should turn off. Then both LEDs should therefore go out. If either LED remains lit, either the transistor is faulty or you have done something wrong.

Only if the transistor passes **both** tests can it be classed as satisfactory.

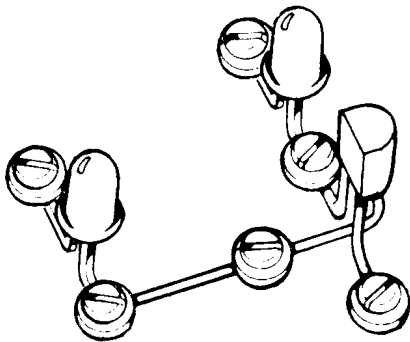

Check 1: The LEDs should both glow, but the one connected to the collector should glow more brightly than the other (this is a small section of the board above. All other components shown on the board should be in place!)

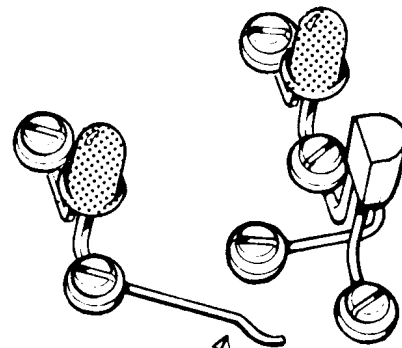

Remove this wire link

Check two: remove the wire link shown. Both LEDs should go out. If they do not, you either have a faulty transistor or a wiring error.

A water indicator

Are your plants thirsty? Because they cannot speak to you, use electronics to communicate with them. This simple circuit monitors the amount of water in the soil.

Or you can check whether it is raining outside without going outside and getting wet!

A simple modification shows the basis behind the so-called 'lie detector'.



Resistors:	One 390 ohms (orange - white - brown) One 100k ohms (brown - black - yellow)
Diodes	One protection diode (1N4001 or similar) One light emitting diode (LED)
Transistors:	One NPN type DS548 or similar small signal type

Miscellaneous:	One 9 volt battery and battery clip 4 lengths of tinned copper wire. 2 x 25cm lengths of insulated hook-up wire. 2 x 12cm lengths spaghetti insulation. 11 self-tapping screws with washers. Baseboard and project overlay No. 3.
-----------------------	--

- (1) Cut out the project overlay for project No. 3 at the back of this book and glue it to your baseboard.
- (2) Mount the wire links first, followed by the two resistors, protection diode, LED and finally the transistor. Be very careful you get the diode, LED and transistor in the correct way around.
- (3) Make up a pair of probe leads 25cm long from the hookup wire and spaghetti insulation (see project 1 for more detailed instructions).
- (4) Check your project thoroughly, then connect the battery to the clip. To check the water indicator out, lick your fingers, then hold the end of a probe in each hand. The LED should come on.
- (5) If you short the probes together the LED should light brightly.

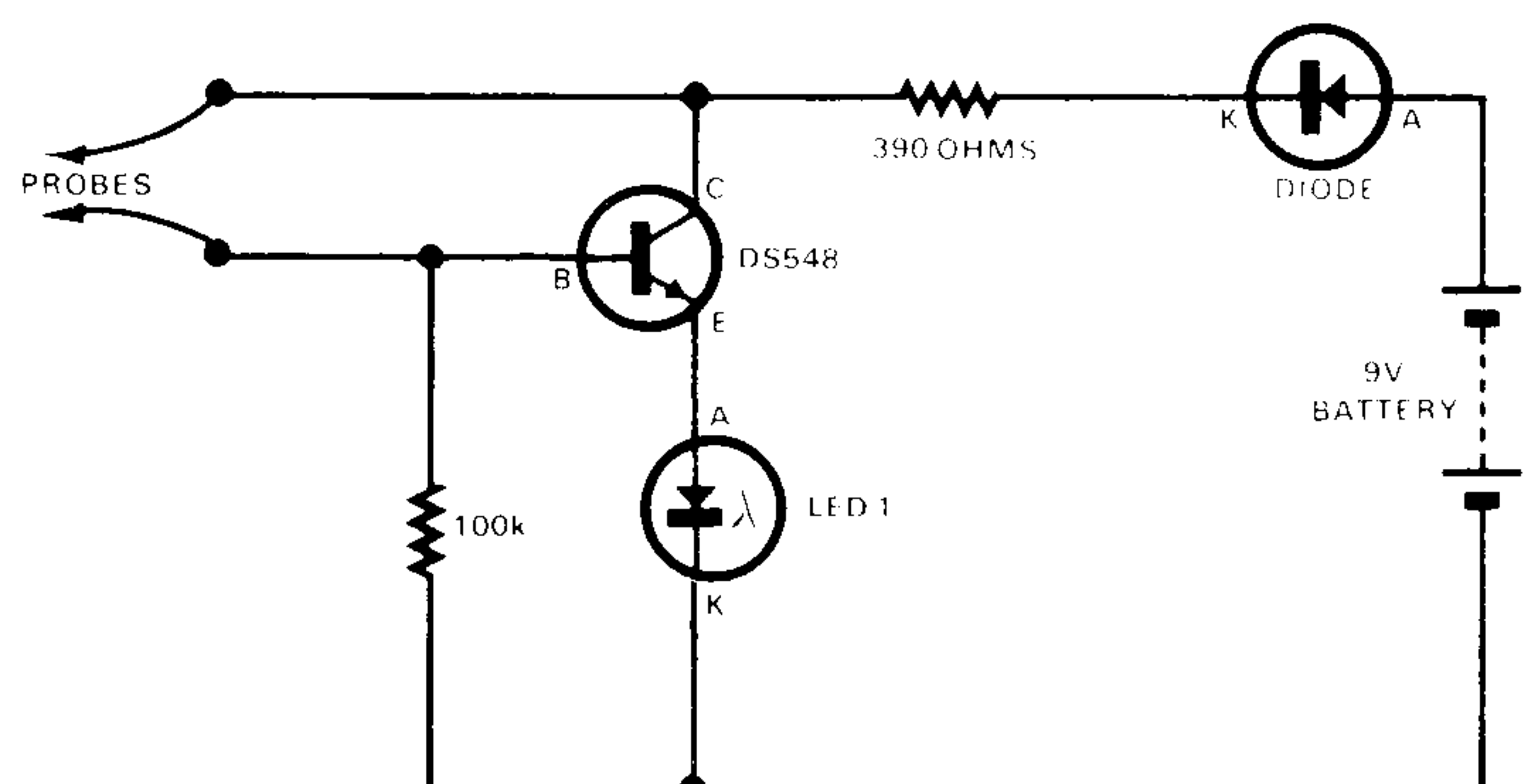

Figure 1

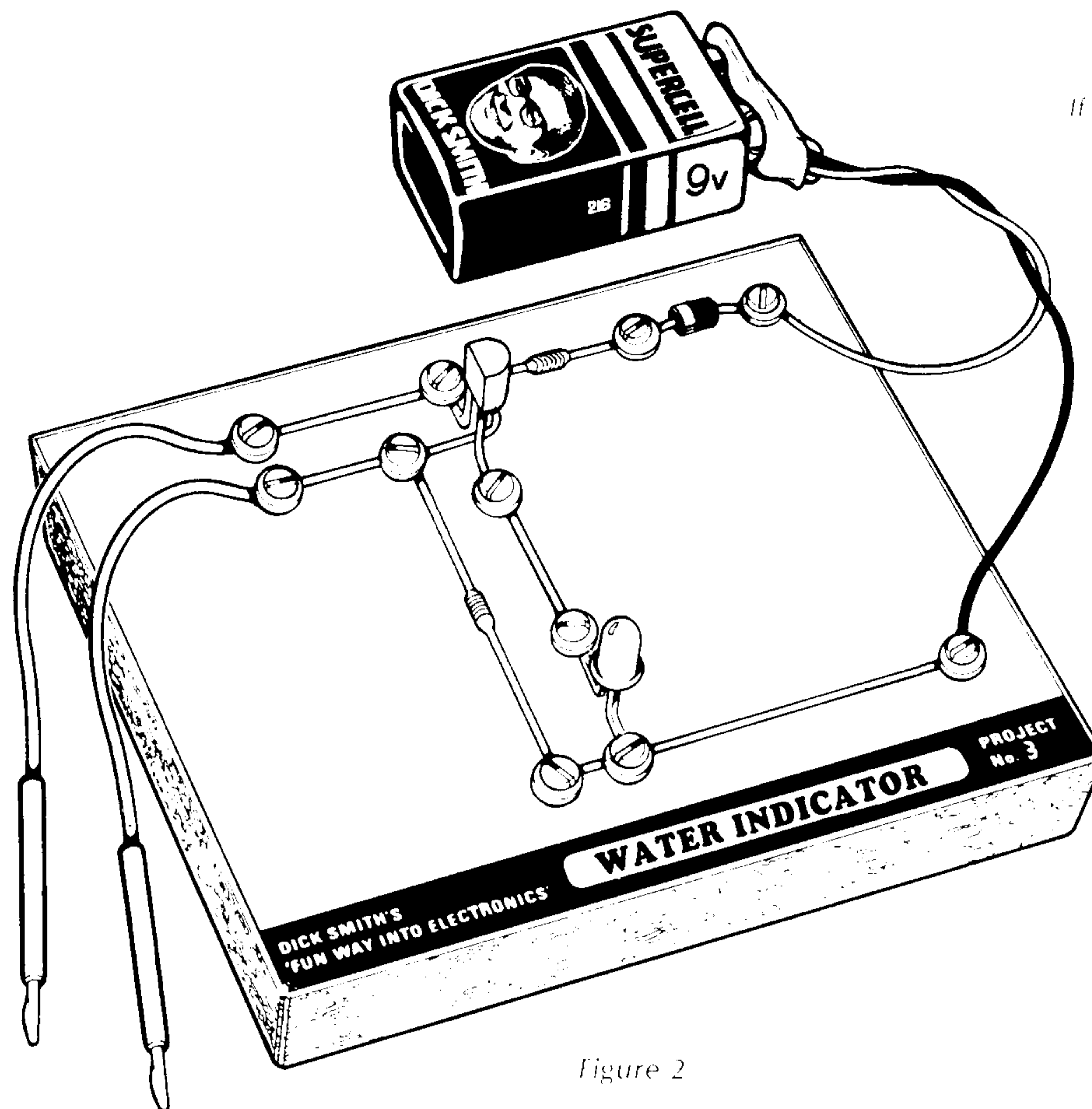

Figure 2

The water indicator layout is very simple: just make sure you get the transistor the correct way around! If you cannot get your circuit to work, it is easy to check the LED out by temporarily removing the transistor and placing a wire link between the emitter and collector (E & C) terminals. If the LED glows, it is ok.

In this circuit, the transistor is acting as a switch. In dry soil, the resistance between the probes is very high; hence the transistor receives little or no base current and it can not turn on. In moist soil, the resistance is very much lower, and the transistor receives enough base current to enable it to turn on, lighting the LED.

Pure water by itself does not conduct electricity. However, the water which comes from our taps, and even the rain which falls, contains impurities which do allow the water to conduct electricity. (That is why it is so important to take care with electricity around pools, laundries, bathrooms, etc etc).

In our case, the probes are placed into damp soil which is able to conduct electricity fairly easily. Once the soil dries out the resistance increases again and the LED goes out.

If you like, you can make a stronger set of probes from stiff wire (such as an unbent coathanger) and a block of wood. This makes the water indicator much easier to use – just poke the probes into the soil. Make sure that you have a good connection between the probes and the connecting wires.

Another use for the water indicator is as a rain alarm. You can place the probe ends in a plastic bucket outside and your LED will come on when it starts to rain. (You'll need to make some fairly long leads to reach outside so make sure they don't get in the way!)

This water indicator will also show the amount of resistance your skin has. If you remove the 100k resistor, the circuit becomes much more responsive to high resistance. Press your fingers on the probes and see if the LED comes on. If your fingers are dry, it probably won't. But if your fingers are moist (as they would be if you are sweating) the LED should be on. If you connect one probe to each hand, you have made yourself an elementary form of lie detector.

Lie detectors work on the principle that people under emotional stress are more likely to perspire. Therefore, anyone who is telling a lie is likely to have lower skin resistance than if they were not telling a lie.



A light/dark indicator

Hello Police – there's a burglar in our house . . .

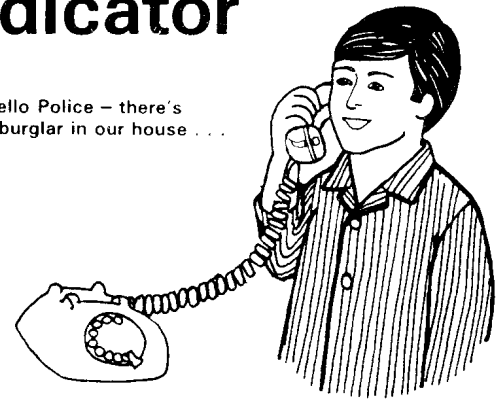

In this project, we introduce you to a circuit which has very wide application in our daily lives: a light detection circuit.

Our light detector is, of course, very simple –but you can see variations of this circuit in such things as street light switches, lift door protectors, safe alarms, etc.

Combine this project with the water indicator described in Project 3 and you have the basis of your own electronic weather station: you'll be able to tell if it is wet or dry as well as light or dark – all electronically!

- Resistors:** One 390 ohm (orange - white - brown)
 One 33k ohm (orange - orange - orange)
 One 1.2k ohm (brown - red - red)
 One light dependent resistor (LDR)
- Diodes:** One protection diode (1N4001 or similar).
 One Light Emitting Diode (LED).

- Transistors:** One NPN type DS548 or similar small signal type
- Miscellaneous:** One 9 volt battery and battery clip
 5 lengths of tinned copper wire
 12 self-tapping screws with washers
 Baseboard & project overlay No 4

- (1) Cut out the project overlay No. 4 at the back of this book and glue it to your baseboard. Connect the wires and components as shown in the circuit diagram (Fig. 1) and the layout diagram (Fig. 2)
- (2) Mount the semiconductors (transistor, diode and LED) last, and make sure you have connected them the correct way around and that the leads are not touching one another.
- (3) Connect the battery to the clip. If all is well, nothing should happen!
- (4) Now cover the light dependent resistor (LDR) with your finger. The LED should now be glowing brightly. Take your finger away and the LED should go out. (You may find that you have to shield the LDR more effectively from light for correct operation.) Try a handkerchief or similar.

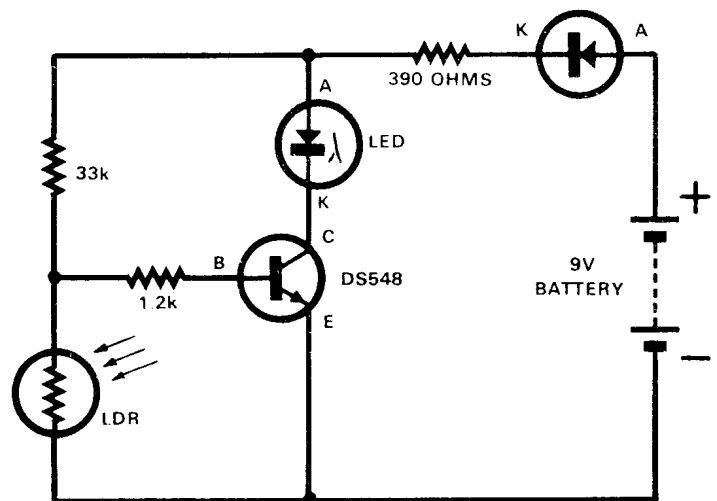

Figure 1

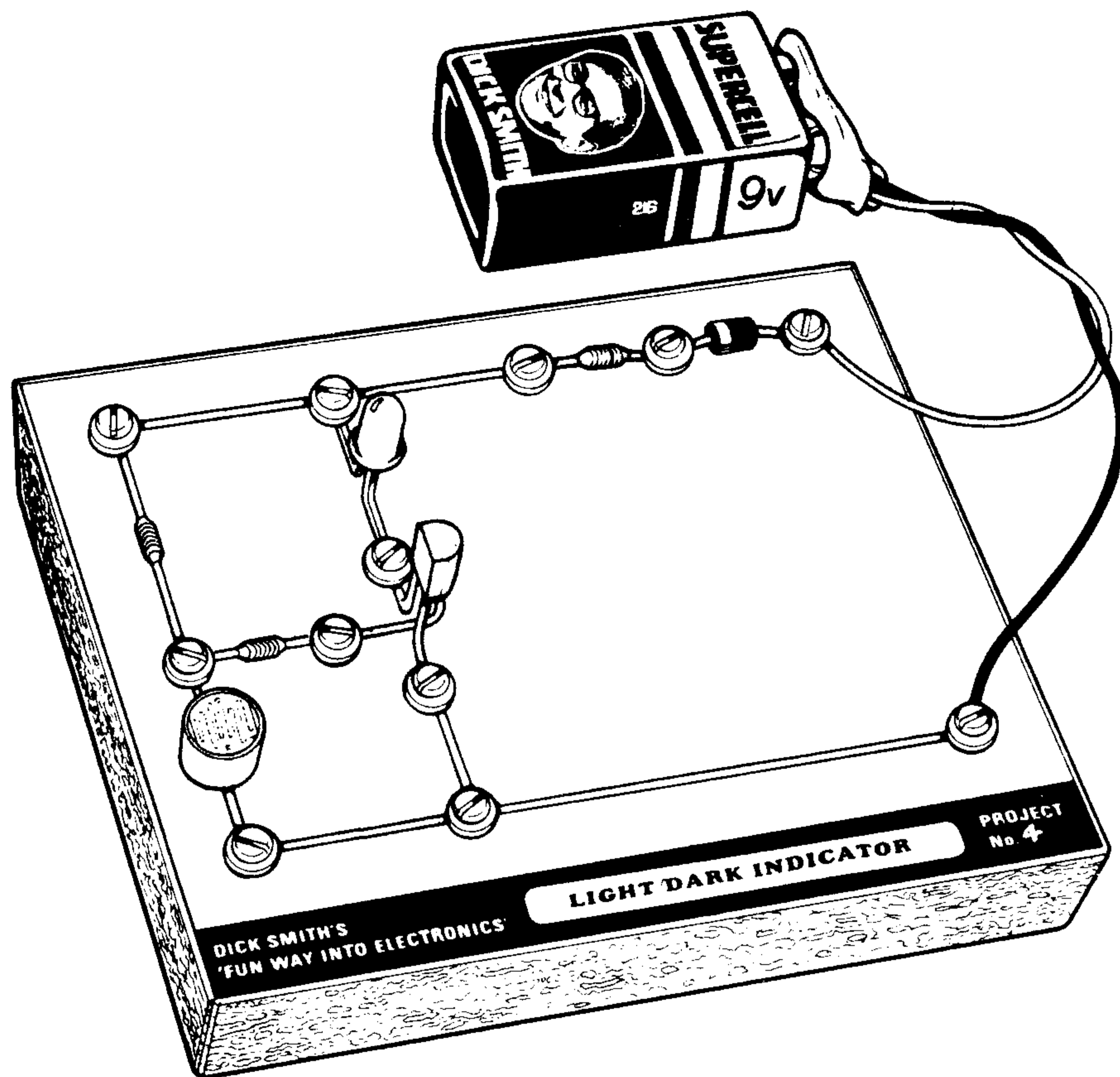

Figure 2

Another very simple circuit – the only points to watch out for are that the transistor is installed correctly (and that the transistor is of the correct type; remember the DS548 and DS558 appear almost identical). The text below tells you how to reverse the operation of this circuit; making the LED light up in light and go out in darkness.

In this circuit, the transistor acts as a switch, turning the LED on and off in accordance with the amount of light falling on the LDR.

If we consider, first of all, the 'dark' state of the LDR (that is, when the LDR has a very high resistance) current flows from the positive supply via the 33k and 1.2k resistors to the base of the transistor. This turns the transistor on, and the LED lights.

If the LDR is in bright light, its resistance falls to a very low level. Most of the current which would have flowed to the transistor is diverted directly to the negative supply. Hence there is no base current to turn the transistor on and the LED stays out.

Electricity behaves a lot like water: it will always try to find the easiest path between two points. When the LDR is dark, the base/emitter junction of the transistor is the easiest path. With the LDR in light, its resistance is very low and it becomes the easiest path.

It is very easy to make this circuit operate in reverse – that is, make the LED light up when the LDR is light, instead of going out as it does at the moment.

All you need do is swap the LDR and the 33k resistor. If everything is ok now, you should find that the LED lights up if the LDR is lit.

Operation is simply a reverse of the previous circuit: when the LDR is dark, it does not allow enough current to flow to the transistor to turn it on. In light, enough current can flow.

You can 'remotely' mount the LDR (that is, away from the layout board) by connecting it via two insulated wires. In this way, you can monitor the amount of light outside without having to go over to the window and open the curtains to have a look!

Another use would be as a warning: for example, with the LDR mounted inside the toilet you could tell if someone was in there : when it was occupied (and the light was switched on) the LED would go out. If no-one was in there and the light was switched out, the LED would be on saying 'all is clear'!

The flasher

You've probably seen those flashing lights on level crossings – or on emergency service vehicles. Guess what makes them work?

That's right: a circuit just like this one!

You can make a number of flashing light circuits, simply by varying a few components.

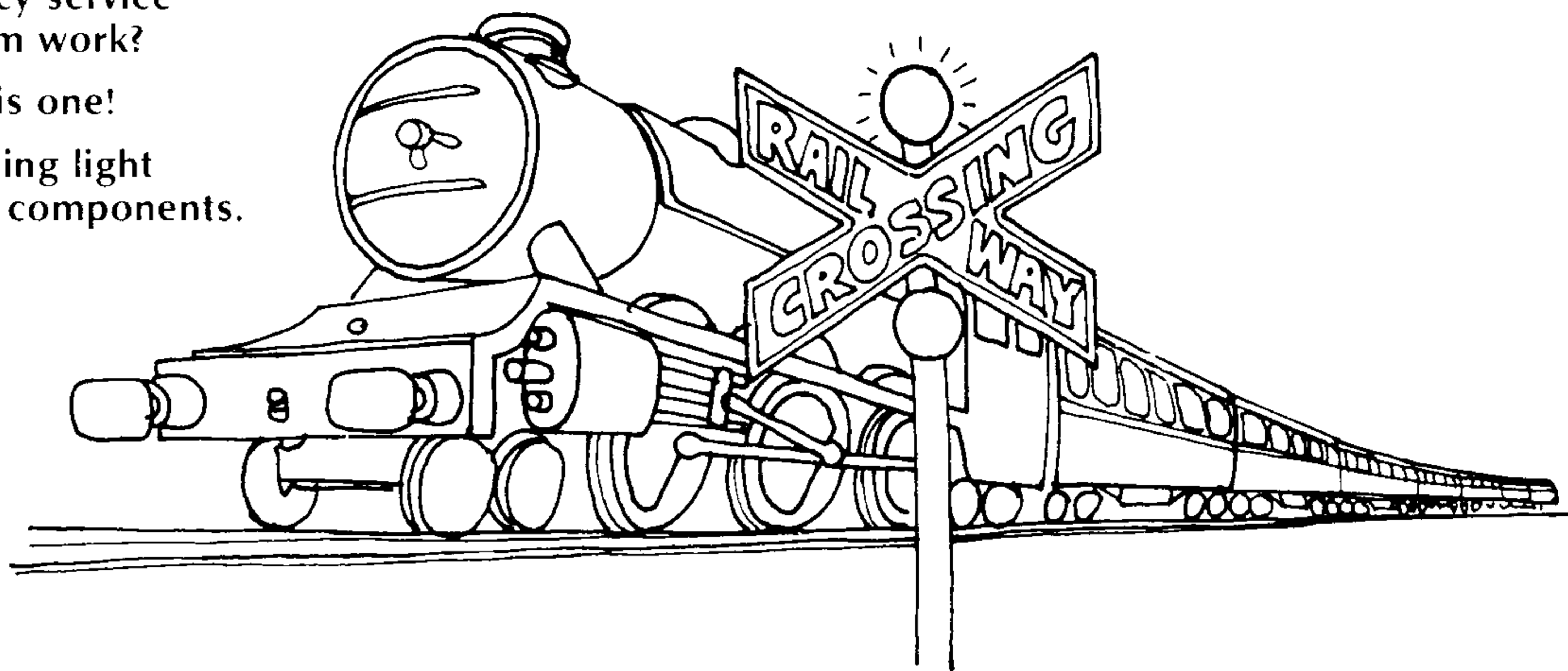

Resistors: One 390 ohms (orange - white - brown)
Two 10k ohms (brown - black - orange)

Capacitors: Two 100uF 10 volt electrolytic type

Diodes: One protection diode (1N4001 or similar)
Two light emitting diodes (LEDs)

Transistors: Two NPN type DS548 or similar small signal type

Miscellaneous: One 9 volt battery and battery clip
Five lengths of tinned copper wire
One 3cm length insulated hookup wire
17 self-tapping screws with washers
Baseboard and project overlay No. 5

- (1) Cut out the overlay for project number five at the back of this book and glue it to your baseboard. As before, drill (or punch) holes where indicated on the overlay to suit the self tapping screws and insert screws with washers.
- (2) Connect the circuit as shown in the overlay and drawings. Where one wire crosses another, use one piece of plastic insulated hook-up wire to stop the wires short-circuiting (or touching one another).
- (3) Mount the semiconductors (diode, LEDs and transistors) last. Check the polarity of these components, and the electrolytic capacitors. Also check that the leads of the transistors are not touching each other.
- (4) Connect the battery to the clip. You should find the two LEDs are flashing alternately at quite a fast rate – almost too fast for your eyes to follow.
- (5) If your LEDs do not flash, something may be incorrectly connected. Check your wiring once more.

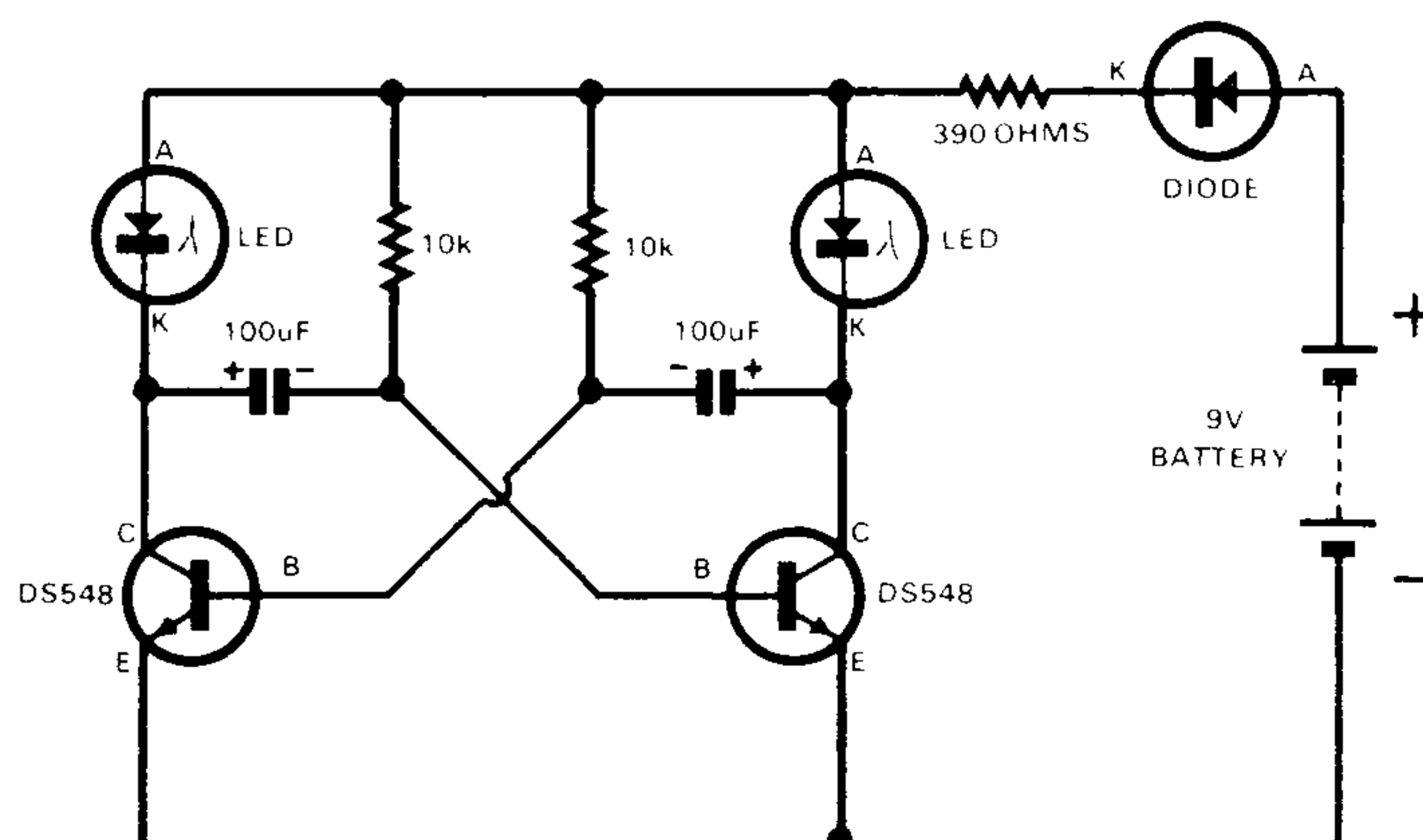

Figure 1

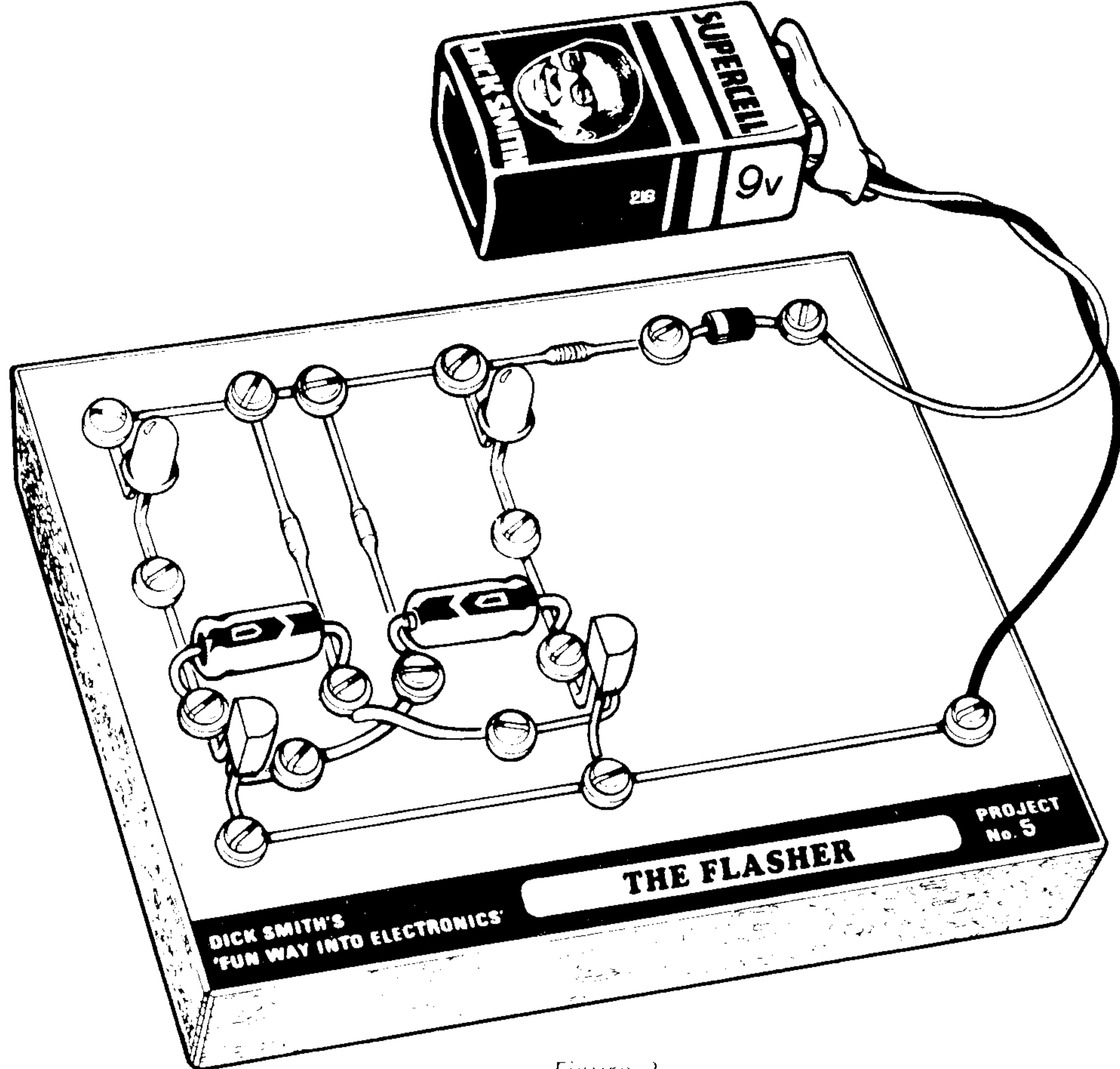

Figure 2

This circuit is a little tricky—there are a number of points to watch. The capacitors must be connected the correct way around (+ to the collector of the transistor in both cases) and the cross-over between the transistors. Apart from these plain sailing...

In project one we showed how electrolytic capacitors can be charged and discharged. This circuit makes use of charging and discharging currents to turn transistors on and off alternately.

When power is applied, each capacitor begins to charge. Because no two components are identical, one will charge faster than its partner. This charging causes current to flow through the base of the opposite transistor (ie, the transistor connected to the capacitor's negative side). When this transistor turns on, it prevents the capacitor attached to its collector from charging. However, when the opposite capacitor is fully charged, current stops flowing and the transistor turns off. This allows the other capacitor to discharge through the 10k resistor, ready to start the cycle all over again.

This cycle repeats itself many, many times per second. And, as we have shown in earlier projects, each time the transistor turns on, the LED between its collector and the positive supply lights up.

The time it takes for each charge/discharge cycle is dependent on the amount of capacitance and resistance in the circuit. The charge/discharge time is called the 'time constant'.

There is a large variety of experiments you can try with this project. Providing you leave the protection diode, 390 ohm resistor, both LEDs and both transistors where they are (and remember the polarity of the electrolytic capacitors) you can alter any of the component values to see what effects you can obtain.

For instance, you can slow the flashing rate down by increasing the capacitor or resistor values. Conversely, speeding it up is achieved by smaller values. You can make each leg of the circuit unequal by using different values, thus obtaining an unequal flashing time. Or you can make the speed variable by putting a 500k potentiometer in series with one of the resistors.

As you can see, there is a lot you can experiment with in this circuit. With a little playing around with values, you should be able to find components which make the LEDs flash once each second – and you'll have made a digital timer!

The type of circuit used in this project is usually called a "multivibrator".

An electronic siren



If there is one sound that is recognised almost universally it would be the wailing of a siren. Police use them, other emergency services use them, burglar alarms use them, people stop and start work to them, air raid warnings use them. . .

An electronic version of the old mechanical siren is very easy to make. Here's how:

- Resistors:** One 47 ohms (yellow - violet - black)
 One 68 ohms (blue - grey - black)
 One 33k ohms (orange - orange - orange)
 One 47k ohms (yellow - violet - orange)
- Capacitors:** One 0.1uF polyester ('greencap')
 One 100uF 10 volt electrolytic
- Diodes:** One protection diode (1N4001 or similar)
 One light emitting diode (LED)

- Transistors:** One NPN type DS548 or similar
 One PNP type DS558 or similar
- Miscellaneous:** One 9 volt battery and battery clip
 Six lengths of plastic insulated hookup wire, approx. 12cm long
 Six lengths tinned copper wire
 21 self-tapping screws with washers
 Baseboard and project overlay No. 6

- (1) Cut out the overlay for project No. 6 at the back of this book, and glue it to your baseboard. As usual, drill holes for all self-tapping screws and insert them with washers into the holes.
- (2) Insert the wire links, resistors and electrolytic capacitors, followed by the diodes, LED and transistors. Be careful in identifying the transistors in this project: they may look identical but they most certainly are not!
- (3) This is the first project to use a loudspeaker. Be careful in attaching the wires to it – see the section on how to make your projects a success at the start of this book.
- (4) There are two sets of 'probes' used in this project to make it operate. These can simply be lengths of approximately 12cm of insulated hookup wire, with 1cm of insulation removed from each end.
- (5) Connect the battery to the clip, and connect the 'siren probes' to each other. Make sure the 'stop probes are disconnected from each other and are not able to touch any other part of the circuit. Your siren should now be operating.

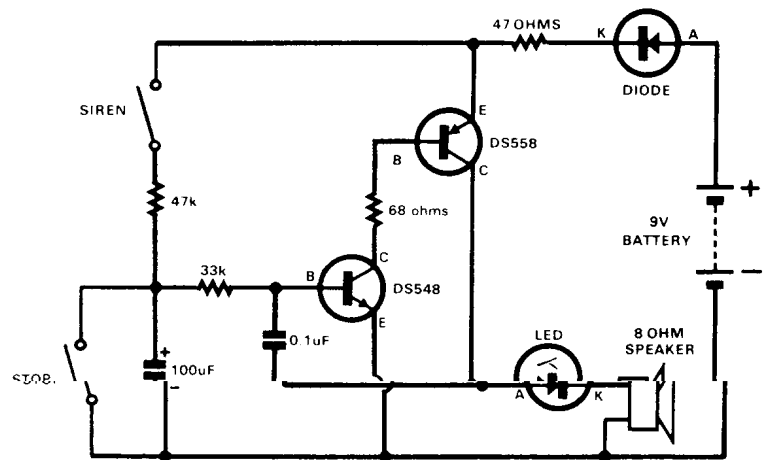

Figure 1

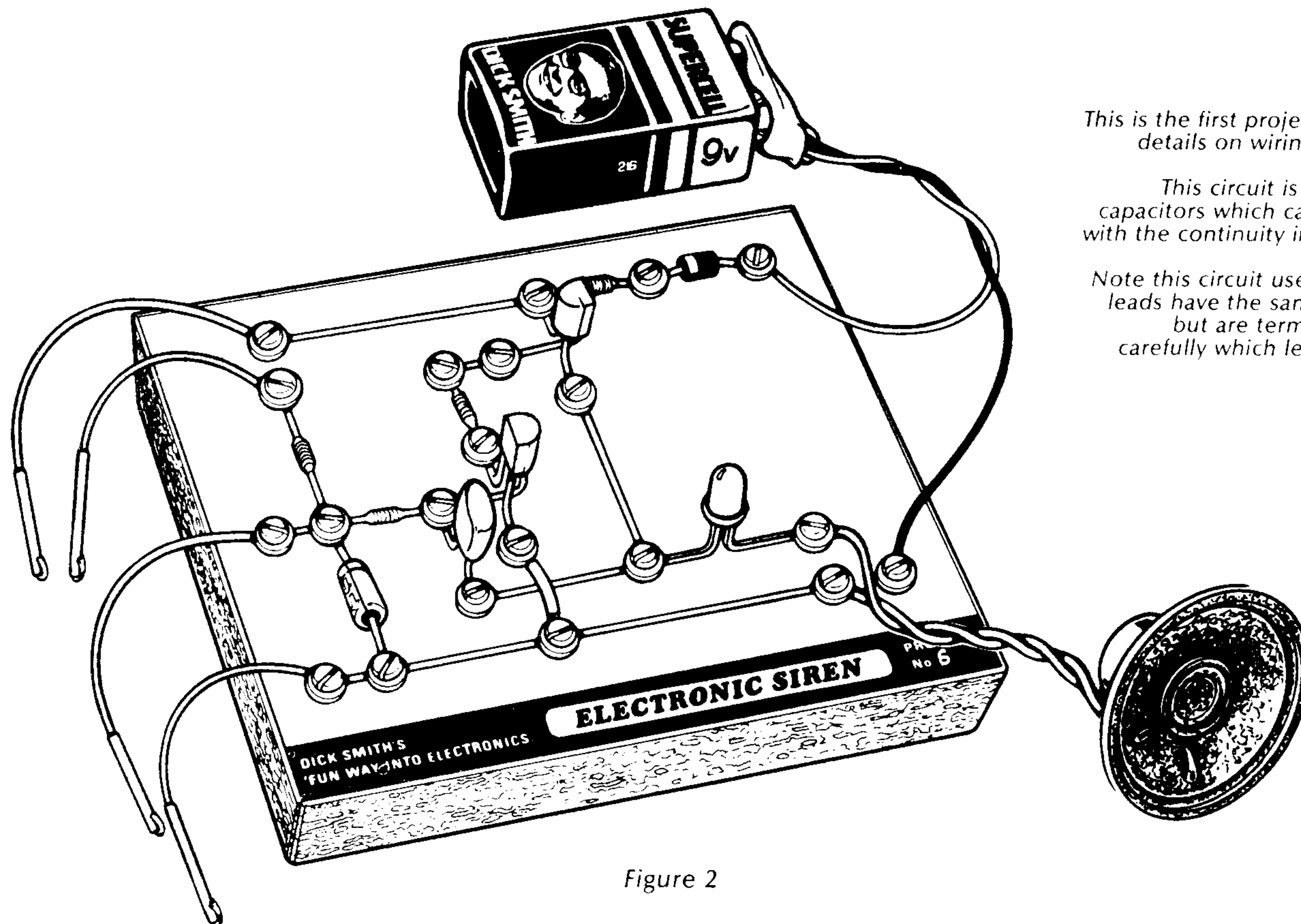

Figure 2

This is the first project to use a loudspeaker: details on wiring to these will be found earlier in the book.

This circuit is also handy for checking capacitors which cannot easily be checked with the continuity indicator. See the details in the text below.

Note this circuit uses a PNP transistor – the leads have the same positions as an NPN, but are terminated differently. Note carefully which leads go to which screws.

This is another circuit which makes use of the charging and discharging currents in a capacitor – indeed, two capacitors.

The sound you hear coming from the speaker is basically caused by the rapid switching between the transistors caused by the charging and discharging of the 0.1uF capacitor. The varying pitch of the siren is caused by the charging and discharging of the 100uF electrolytic capacitor.

Whereas in the last project only one transistor could be on at any given time, in this circuit both transistors are turned on and off in near unison. The 0.1uF capacitor (called a 'feedback' capacitor it feeds some of the 'output' signal back to the 'input') charges and discharges rapidly.

The 100uF capacitor charges and discharges very slowly – and then only when the 'siren probes' are connected. As it charges, the pitch rises. When the probes are disconnected, it slowly discharges, and the pitch falls.

If the 'stop probes' are connected, the electrolytic capacitor is instantly discharged, and the oscillations (the name given to the rapid sound fluctuations) stop immediately.

You should be able to reproduce the wail of a fire engine very closely. If you want to experiment, there are three components you can try altering to see what effects you can get: the 47k resistor, and both the 0.1uF and 100uF capacitors.

The 47k resistor can be substituted with any value between 10k and 100k. The 100uF and 0.1uF capacitors, likewise, can be changed for values above and below those called for on the circuit. You should find different values give different sounds.

Another useful feature of this project is that you can use it to check suspect low value capacitors – the ones not easily checked with the continuity checker.

If you have a suspect 0.1uF, .01uF or .001uF capacitor, you can check it out by substituting it for the feedback capacitor. If you get a similar sound from the substituted capacitor as you get from **another capacitor of the same value**, then the capacitor is not faulty.

If, however, it does not work at all, or makes a markedly different sound, the capacitor can be regarded as suspect.

You can also check out a battery: results should be roughly similar for good batteries.

A dog and cat communicator

A dog and cat communicator? Try it, you might be surprised! Trainers tell us that dogs and cats respond to high frequency sounds – higher than we humans can hear – and you might just hit on the right note to train your pooch to come in for dinner.

A simple modification turns this project into an alarm – which can be used to surprise unwelcome visitors or warn you without them knowing.

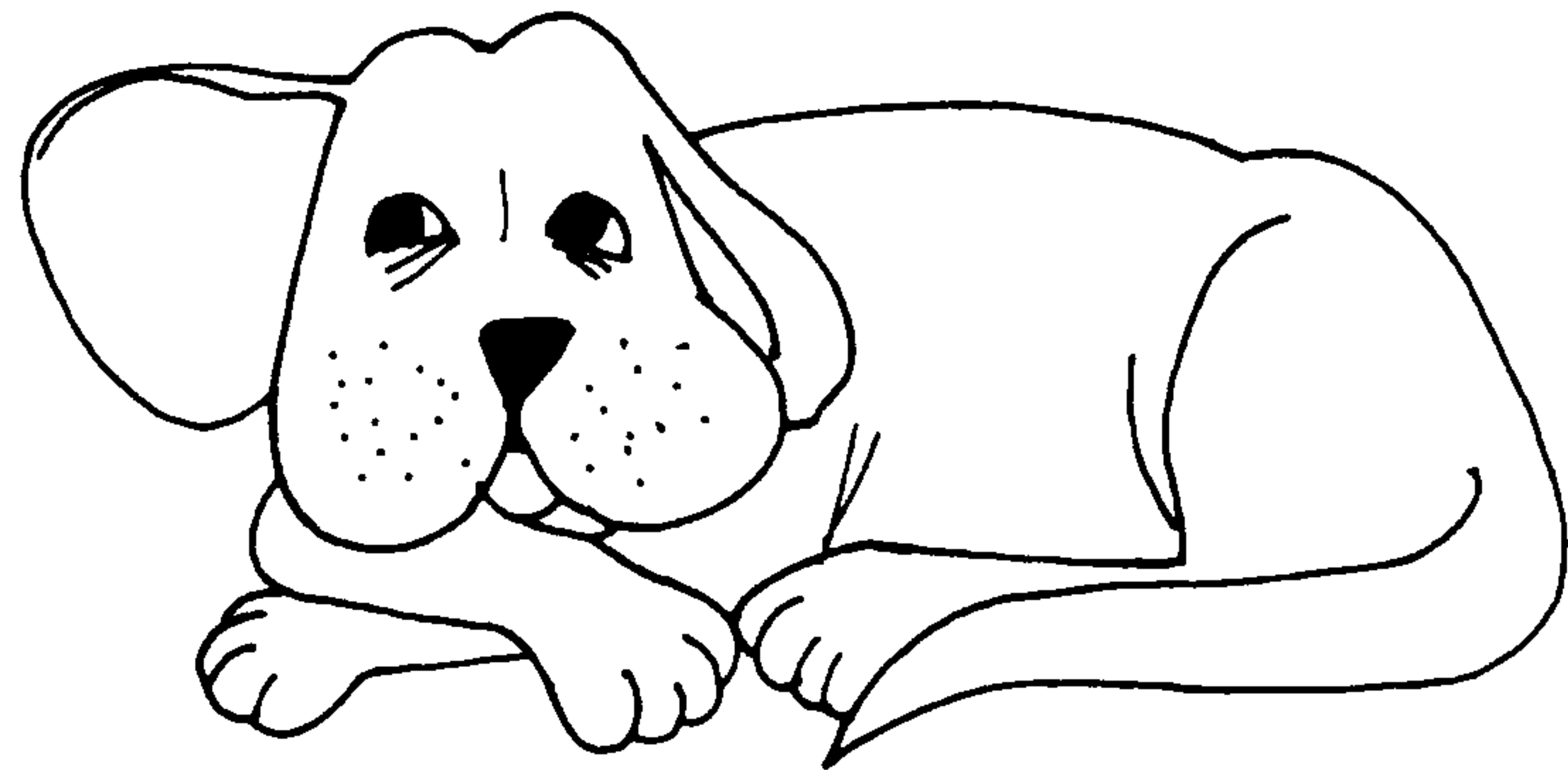
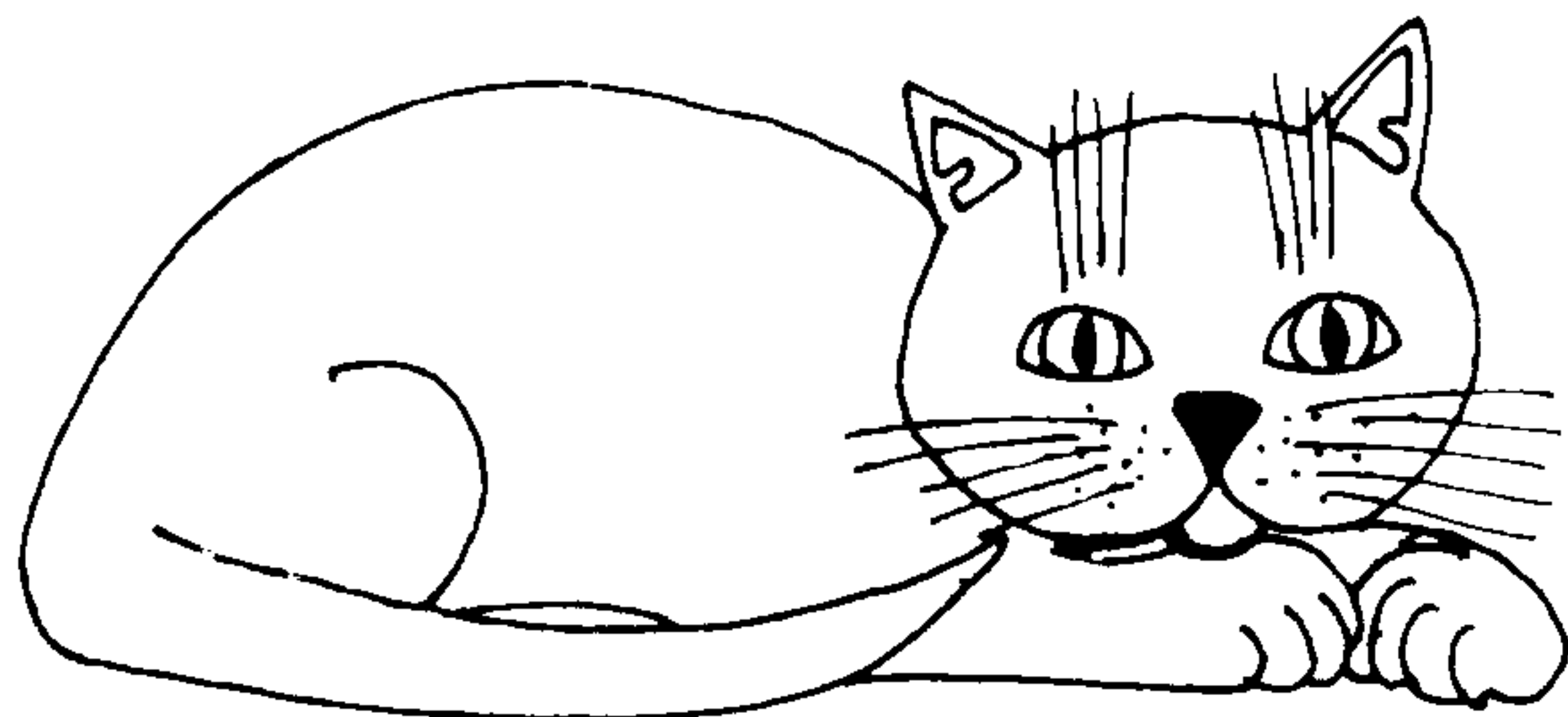

Resistors: One 100 ohms (brown - black - brown)
One 1.2k ohms (brown - red - red)
Two 10k ohms (brown - black - orange)
One light dependent resistor (LDR)

Capacitors: Two .01uF polyester 'greencaps' (for the dog & cat communicator only)
Two 0.1uF polyester 'greencaps' (for the burglar alarm only)

Diodes: One protection diode (1N4001 or similar)

Transistors: Two NPN type DS548 or similar

Miscellaneous: One 9 volt battery and battery clip
One 8 ohm loudspeaker
Two 12cm lengths insulated hook-up wire
One 5cm length insulated hook-up wire
Three lengths of tinned copper wire
17 self-tapping screws with washers
Baseboard & project overlay No. 7.

- (1) Cut out the project overlay as normal, glue it to the baseboard. Assemble the components in the normal way, taking care of polarised components.
- (2) If you wish to make the dog and cat communicator, use the two 0.01uF capacitors. If you wish to make the burglar alarm, use the two 0.1uF capacitors.
- (3) When the battery is connected, the tone emitted from the speaker should be quite high if the LDR is in light. As you make the LDR progressively darker, the pitch should drop.

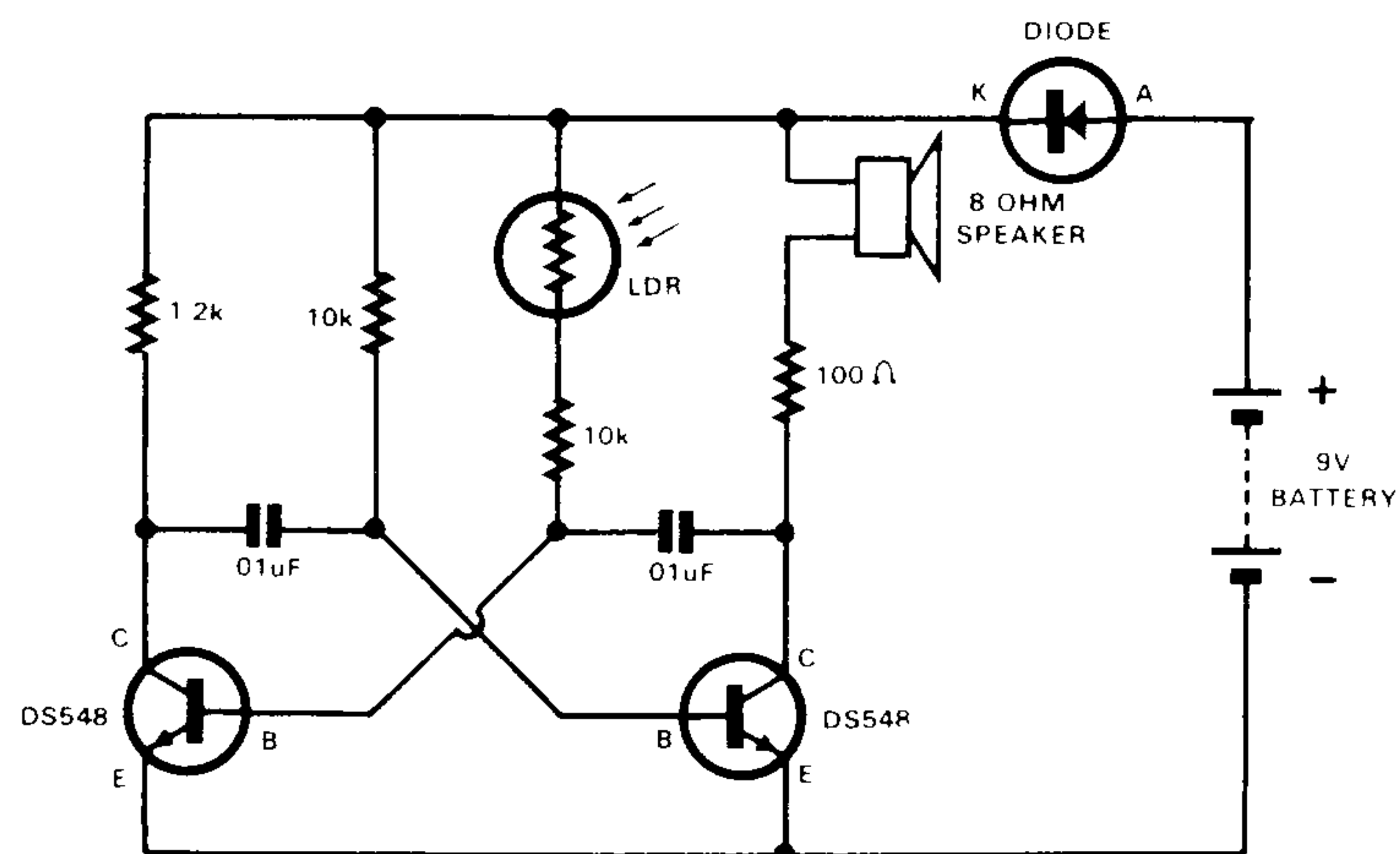
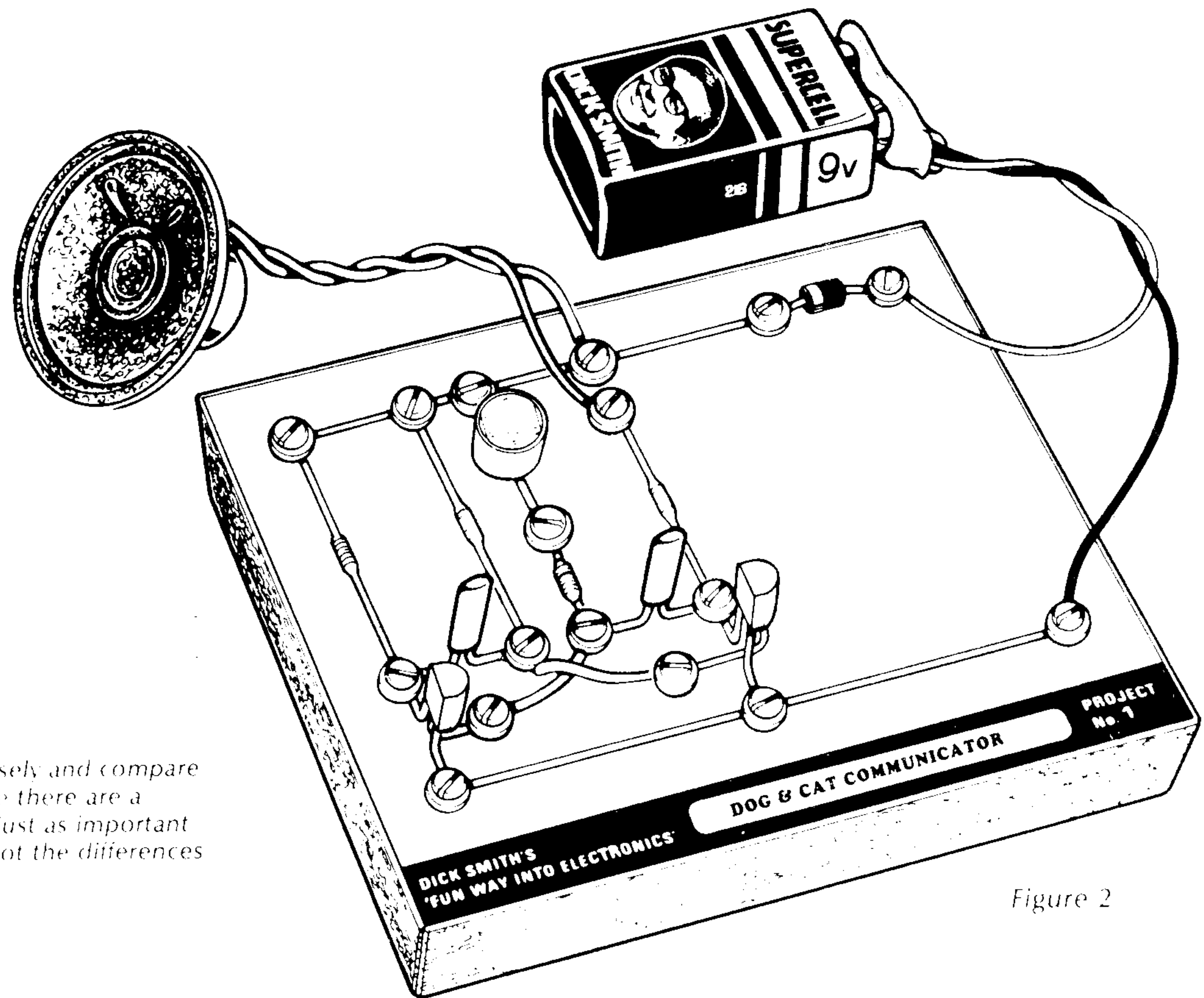

Figure 1



If you look at this circuit closely and compare it to project five, you will see there are a number of similarities. But just as important are the changes. Can you spot the differences in the two circuits?

Figure 2

The difference between this multivibrator and the others we have described is the light dependent resistor connected in series with the 10k resistor. This LDR is used to vary the charging rate of one of the capacitors.

Remember our light/dark indicator? (Project No. 4) In darkness the LDR resistance was very high, while in light it fell to a very low level.

We use this feature to allow variable pitch according to the light level on the LDR.

The dog and cat communicator uses lower value capacitors than does the burglar alarm. This is to give a higher pitch in the dog and cat communicator (the capacitors take a shorter time to charge).

Using the electronic communicator:

By varying the amount of light on the LDR, you can create many different sounds. It is possible to train your dog or cat to respond to these sounds.

A famous physiologist, Ivan Pavlov, used just such a technique to train a dog to respond in certain ways (you may have heard of Pavlov's dog).

Just before your four legged friend is fed, make a certain sound to him with the communicator. After a week or so, the animal may associate food with this sound – just the mere sound should bring him running to his bowl in anticipation.

You can make a variety of different sounds, so you may be able to make him respond to different sounds for different purposes: when it is time to go out for a walk; go to bed, etc etc.

Using the burglar alarm:

If you place the alarm circuit in a normally dark spot, it should stay silent. If someone shines a torch on it, or turns on a light so the LDR is lit, your alarm should sound a warning note.

If you mount the LDR outside (or where you need protection) and run two insulated wires back to the alarm unit in your bedroom, the alarm will be really secret and no-one will know about it until the alarm sounds in your room.

If the volume of the alarm is a little low for some applications, you may find adding an amplifier such as that described in project 15 helps.

This circuit was developed by Dick Smith many years ago and sold in a small box with a label on the front. This label gave alternatives besides two light emitting diodes: yes/no; in/out; heads/tails; etc. Many thousands of these were used throughout the country to make important decisions. Even the Prime Minister of Australia had one on his desk for the most crucial decisions!

An alternative use for this project is to experiment with ESP – extra sensory perception. Have you got it?

Find out with this simple project!

A decision maker

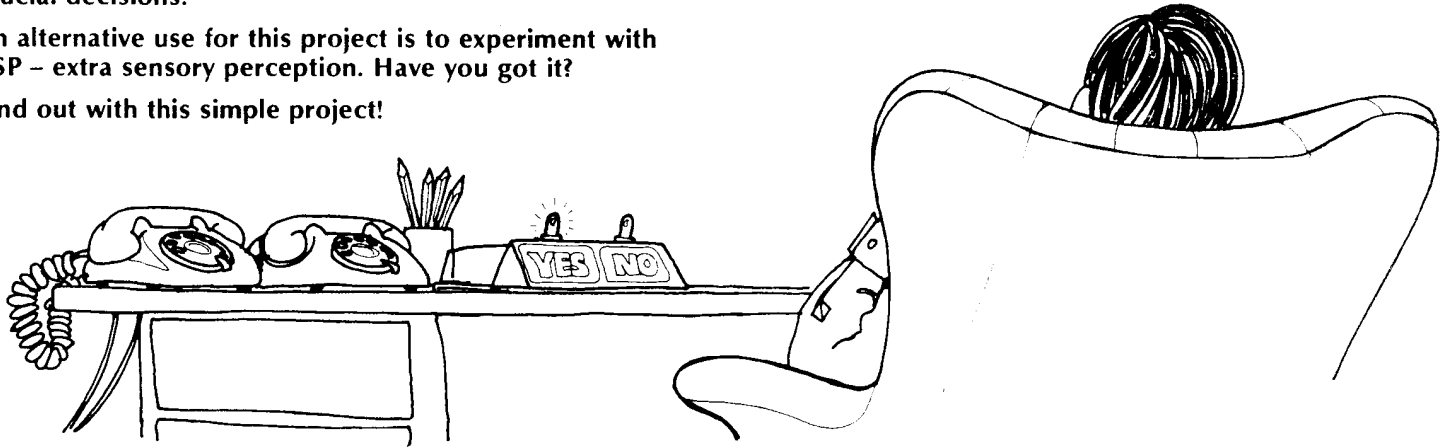

Resistors: One 390 ohms (orange - white - brown)
 Two 1.2k ohms (brown - red - red)
 Two 33k ohms (orange - orange - orange)
 Two 100k ohms (brown - black - yellow)

Capacitors: Two 0.1uF polyester ('greencaps')

Diodes: One protection diode, 1N4001 or similar.
 Two light emitting diodes (LEDs)

Transistors: Two NPN type DS548 or similar small signal types

Miscellaneous: One 9 volt battery and battery clip
 Seven lengths tinned copper wire
 Two lengths insulated hookup wire, approx. 12cm long.
 One length insulated hookup wire, approx. 5cm long
 23 self-tapping screws and washers
 Baseboard and project overlay No. 8

- (1) You should be getting used to our easy method of construction. Watch out for the polarised components, of course (diode, LEDs and transistors) and use the short length of insulated hook-up wire for the cross-over.
- (2) A pair of probe leads (used to start and stop the circuit) can be made by removing 1cm of insulation from each end of the the insulated hookup wires.
- (3) After checking your circuit thoroughly, connect the battery to the clip. You should find one, and only one, LED comes on and stays on.
- (4) When the probes are connected together, both LEDs will appear to come on, although they will appear slightly dimmer than the one that was on. In actual fact, they are oscillating, just as in the flasher. The difference is that in this circuit they are oscillating far too quickly to be able to see the individual flashes with the eye. When you disconnect the probes, only one of the two LEDs will stay on – the LED which was on at the precise moment the probes were disconnected.

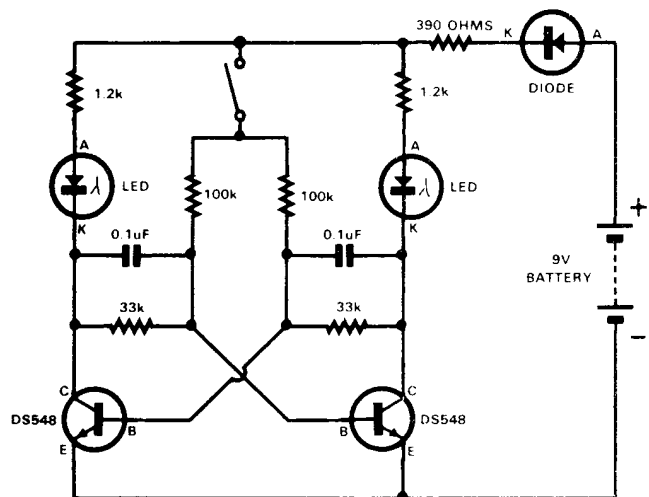

Figure 1

You should have no problems with this circuit – you should be getting pretty good at making them by now!

If you want to be really smart, you can use a green LED for one side (the 'yes') and a red LED for the other (the 'no'). Green LEDs are easy to buy, but they are slightly more expensive than red ones.

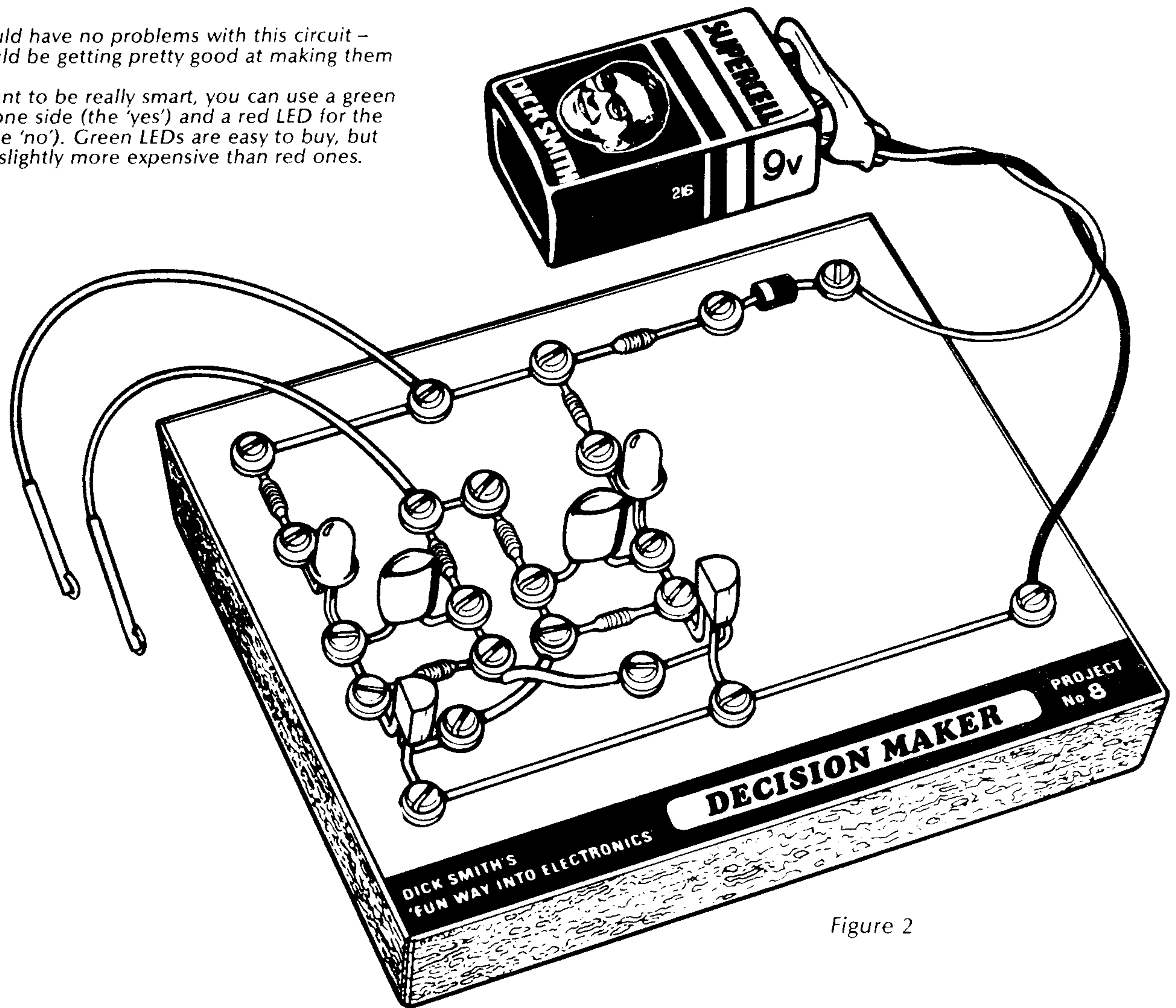

Figure 2

As we mentioned, this circuit operates in almost exactly the same way as does 'the flasher' (project No. 5). The reason the speed is increased is to stop cheating – there is no way you can disconnect the probes at a certain time to obtain a certain result, because the LEDs are flashing too fast.

You can label each LED with the alternatives (and others) listed above and let your decisions be made electronically.

Or, as mentioned in the introduction to this project, you can also check out your 'ESP' rating by trying to nominate which LED will be on at the moment the probes are disconnected. Try first nominating the first one that comes into your head. Or try really concentrating on the LEDs. Concentrate hard on a particular LED and see if it will stay on – maybe under your will!

If you wish, you can slow the speed of oscillating down – to the point where you can see the LEDs flashing individually if you wish. Substitute higher value capacitors for those specified – say up to 100uF.

Just remember, if you use electrolytics, to keep the '+' end of the capacitor connected to the transistor collector; and the '-' end to the opposite transistor's base.

You can make the values unequal for unequal flashing times.

Morse code communicator

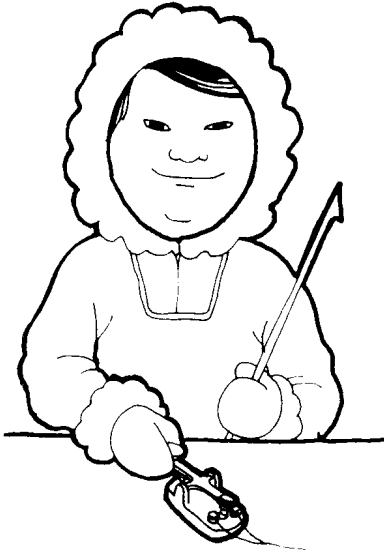

It is a fact that, if conditions are so bad that all other forms of communication fail, Morse code transmissions can often get through. It was the first form of radio communication, and in these days of space satellites, you can still hear amateur radio operators talking to each other around the world in Morse code – just for the sheer pleasure of it.

This project will help you learn Morse code and communicate with others who know this special 'language'.

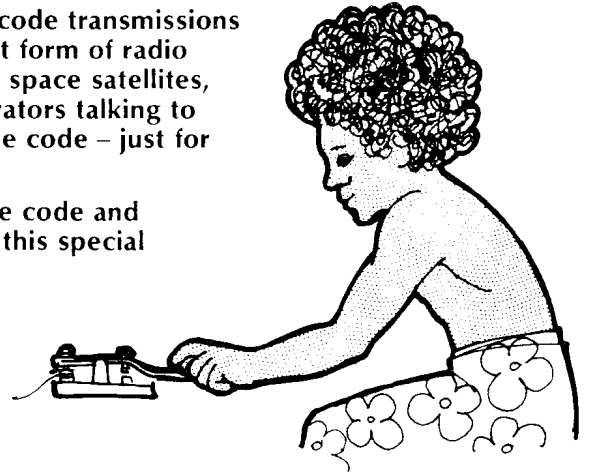

Resistors:	One 47 ohms (yellow - violet - black) One 100 ohms (brown - black - brown) One 1.2k ohms (brown - red - red) Two 10k ohms (brown - black - orange)
Capacitors:	Two 0.1uF polyester 'Greencaps'
Diodes:	One light emitting diode (LED) One protection diode (1N4001 or similar)
Transistors:	Two NPN type DS548 or similar small signal type

Miscellaneous:	One 9 volt battery and battery clip One Morse Code Key One 8 ohm loudspeaker Three lengths of tinned copper wire One 5cm length of insulated hook-up wire Four 12cm lengths insulated hook-up wire 18 self-tapping screws with washers Baseboard & project overlay No. 9
-----------------------	---

- (1) Assemble your project in the normal manner on the project overlay glued to a baseboard. Take care with polarised components.
- (2) A morse key is required for this project. While it is possible to fashion a key from a piece of bent tinfoil or brass and a drawing pin attached to a piece of wood, this could actually impair your learning of Morse code and make your sending quality poor. It is better to invest in a cheap, but properly made, Morse practice key. (At the time of writing, the Dick Smith practice key, Cat No. D-7105, sells for under \$2.00)
- (3) Check your wiring, and if it is correct, connect the battery to the clip. Nothing should happen until you press the Morse key.
- (4) You should hear a tone coming from the speaker, and the LED should light up. Release the key and the tone (and LED) should stop.

This arrangement of components should be quite familiar to you by now. It is a very popular circuit in electronics, called a 'multivibrator', which, as we have described in the previous projects, is designed to turn the transistors on alternately.

The only difference between between this circuit and the previous ones is that there is a speaker included in one 'leg' of the multivibrator. As the transistors turn on and off rapidly, a tone is heard from the speaker.

You can alter this tone by using different capacitors, as in previous projects: the higher the value of the capacitor, the lower the tone.

There are two components in this project which are there purely for protection. One we have already discussed in previous projects is the diode. The other is the 47 ohm resistor. While this resistor is theoretically necessary to protect the LED from excess current, it does have one drawback: it decreases the volume available from the speaker.

If you wish, this resistor may be replaced by a wire link, and you will increase the volume. While this may exceed the ratings of the LED, in all our experiments we have not been able to damage a LED in any way! It's up to you.

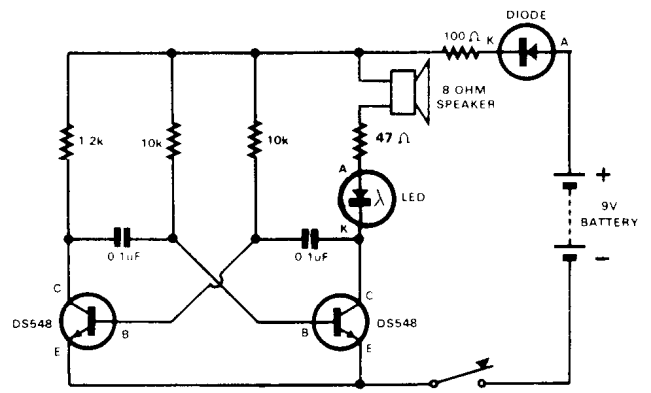

Figure 1

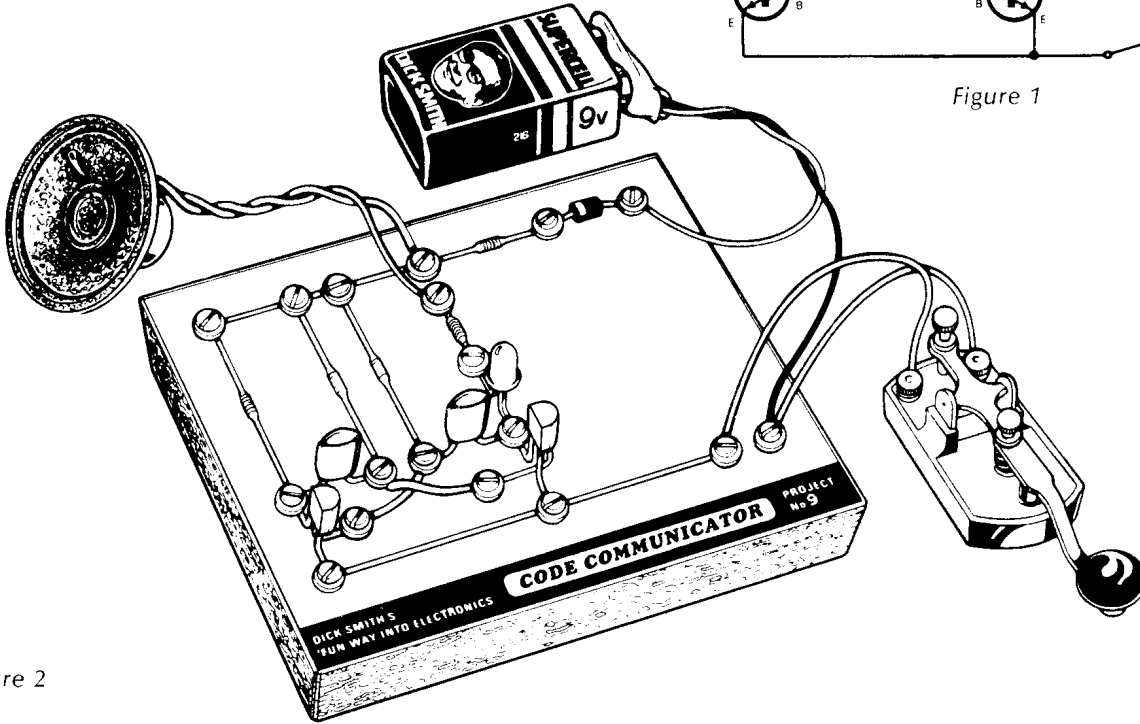

Figure 2

Each letter, numeral and punctuation mark is represented by its own individual series of sounds. In time, you will be able to recognise these sounds as belonging to that letter, and be quite fast at receiving them.

Before we go any further, let's try and get on the right track. Morse code is **not** dots and dashes. If you try to think of Morse as dots and dashes you will never learn it properly. Because Morse is an 'aural' language (that is, received by the ears and not the eyes) it should never be represented in dot and dash form.

Instead, try to say Morse as 'dits' and 'dahs'. A 'dit' for example, is simply a short sharp note, made by quickly pressing the key and releasing it. A 'dah' is a longer note, roughly three times as long as a 'dit'. You hold the key down for three times as long.

The easiest letters to learn are those which are represented by a 'dit' (E); and a 'dah' (T).

Practise them on your code communicator, saying them to yourself as you do them over and over.

All other letters and numerals are combinations of dits and dahs. When a letter or number is composed of a 'dit' followed by another dit or a dah, it is easier to say and remember if you do not try to say the 't' of 'dit' except on a 'dit' which ends a group of characters.

For example we say letter 'B' as dah-di-di-dit; not dah-dit-dit-dit. See how much more easily it rolls off your tongue? Between each letter of the same word, we leave a slight gap so as not to confuse one group of letters with another. Between each word we leave a slightly longer gap.

Don't try to learn too many letters at once.

The international Morse code.

A	di dah	G	dah dah dit	M	dah dah	S	di di dit	Y	dah di dah dah
B	dah di di dit	H	di di di dit	N	dah dit	T	dah	Z	dah dah di dit
C	dah di dah dit	I	di dit	O	dah dah dah	U	di di dah	.	(full stop) di dah di dah di dah
D	dah di dit	J	di dah dah dah	P	di dah dah dit	V	di di di dah	?	(question) di di dah dah di dit
E	dit	K	dah di dah	Q	dah dah di dah	W	di di dah	Error sign	di di di di di di di dit
F	di di dah dit	L	di dah di dit	R	di dah dit	X	dah di di dah		

NUMERALS:

1	di dah dah dah dah	6	dah di di di dit
2	di di dah dah dah	7	dah dah di di dit
3	di di di dah dah	8	dah dah dah di dit
4	di di di di dah	9	dah dah dah dah dit
5	di di di di dit	0	dah dah dah dah dah

Try to decode this message:

dah di dah dit di dah dah dit
 di dah dah dit dah di dah dah dah dah dah dit dit
 di dah dit dit dah dit dah dit dit di dit di di di dah dit
 dah dah dit di di dah dah di dit

Music maker



No longer need you spend hundreds of dollars to enjoy the sound of an electronic organ: here's the Fun Way to do it – build your own!

You can even compose your own tunes on this one.

Resistors	Two 100 ohms (brown - black - brown) Two 1.2k ohms (brown - red - red) One 1.5k ohm (brown - green - red) Four 2.2k ohms (red - red - red) Two 3.3k ohms (orange - orange - red) One 3.9k ohm (orange - white - red) Two 10k ohms (brown - black - orange)
Capacitors:	Two 0.1uF polyester 'greencaps'
Diodes:	One light emitting diode (LED) One protection diode (1N4001 or similar)
Transistors:	Two NPN type DS548 or similar

Miscellaneous:	One 9 volt battery and battery clip One 8 ohm loudspeaker One 25cm length insulated hookup wire One 5cm length insulated hookup wire Two 10cm lengths insulated hookup wire Three lengths tinned copper wire One 10cm length 'spaghetti' insulation 27 self-tapping screws and washers Baseboard & project overlay No. 10
-----------------------	---

- (1) Another multivibrator circuit, but different again! Connect the components up as shown on the overlay, taking particular care with all those resistors.
- (2) Connect the speaker using the two 10cm lengths of hookup wire; use the 5cm length for the cross-over between the transistors. The 25cm length is used to make a 'probe' with which you touch the screws to play each note. Slide a 10cm length of spaghetti insulation onto one end to give it a little more rigidity.
- (3) As in the last circuit, a resistor is added to protect the LED. Taking note of the comments in Project 9, you can remove the 100 ohm resistor between the LED and loudspeaker terminals and replace it with a wire link. (If you remove the other 100 ohm resistor, the notes change in frequency).
- (4) If you like, the LED can be removed instead of the 100 ohm resistor. Do not remove both the LED **and** 100 ohm resistor: one or the other!
- (5) After thorough checking, connect the battery. As you touch the various screws between the resistor 'string', various notes should sound. They should roughly correspond to the notes marked on the overlay – the notes of a musical scale.

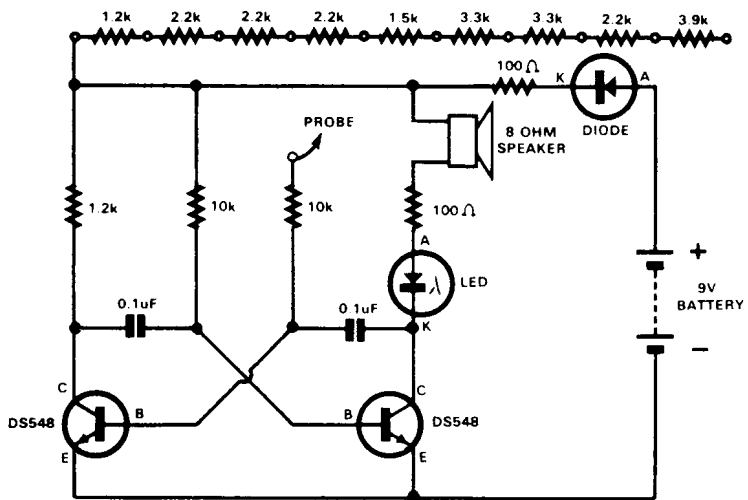

Figure 1

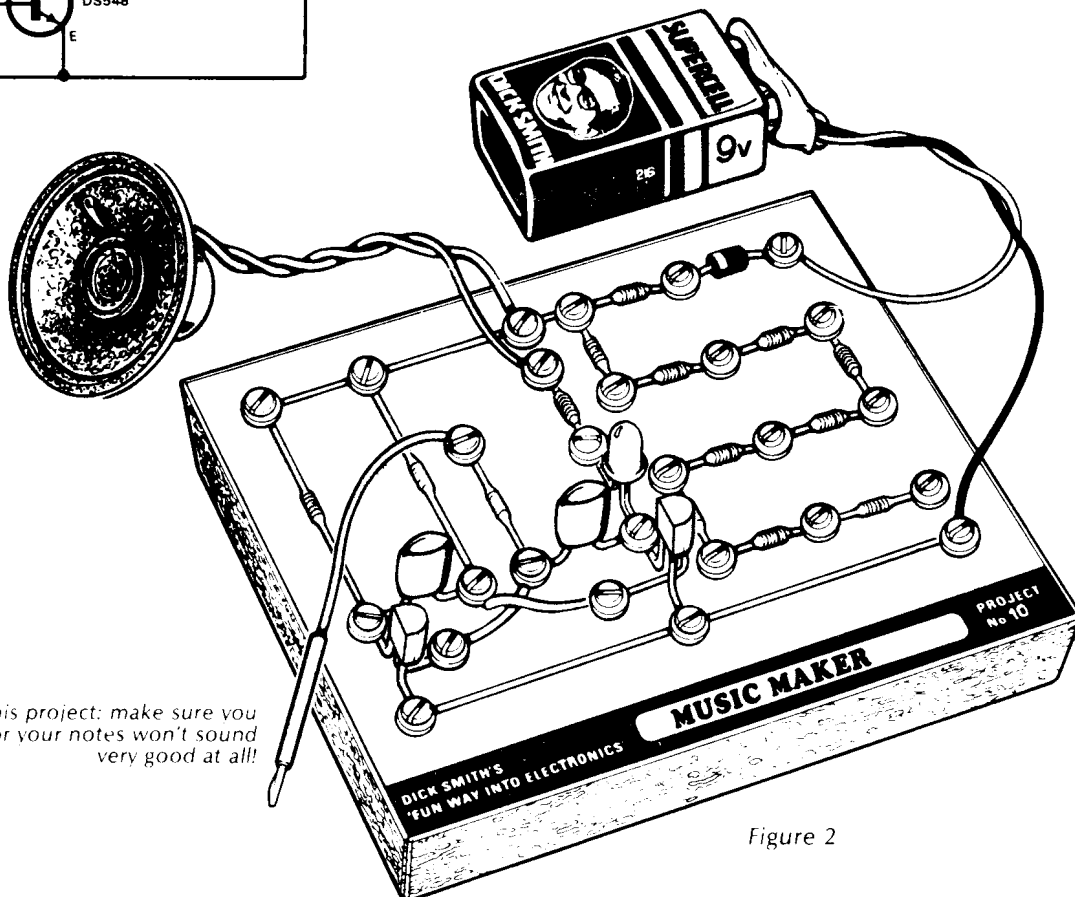

Figure 2

There are a lot of resistors in this project: make sure you get them in the right places, or your notes won't sound very good at all!

In this multivibrator circuit, one of the resistors controlling the rate of charge of a capacitor is made variable. In actual fact, we could use a potentiometer in place of the resistor string (try it if you like) but selecting individual notes and playing a tune is a problem.

So we use a number of carefully selected resistors which give tones corresponding to the notes of a piano.

The resistors chosen cover slightly more than one octave, so it is possible to play many popular tunes. The screws are labelled with the notes they represent.

Tunes can be played simply by moving the probe onto the various screws. Try to work out this simple tune:

C C G G A A G F F E E D D C
 G G F F E E D G G F F E E D
 C C G G A A G F F E E D D C

If you find that the notes are 'sharp' or 'flat', it may be that one of your resistors is higher or lower in value than the ones we used. This is caused by component 'tolerance' – as we mentioned before, no two components are identical, even though they may be marked with the same value.

If you find very differing notes which sound wrong to the ear, try using other resistors (close in value to those called for in the circuit).

A sound effects generator



This is one of the projects that you'll either love or hate. Or you will love and others will hate. With it, you can make a large variety of noises – it is, in fact, a simple sound effects generator.

You can make it sound like a 'put put' motor boat, a speed boat, water drops on a tin roof, a hospital heart beat monitoring machine, the tik tok of a grandfather clock, even the noise of a cricket.

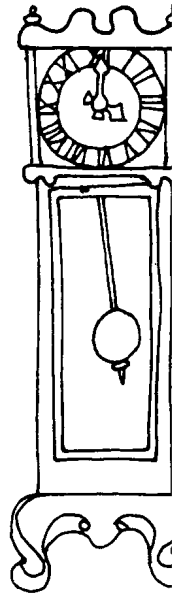

- Resistors:** One 4.7k ohms (yellow - violet - red)
One 500k ohms variable type (potentiometer)
- Capacitors:** One 10uF 16 volt electrolytic type
- Diodes:** One protection diode, 1N4001 or similar
- Transistors:** One light emitting diode (LED)
One NPN type DS548 or similar small signal type
One PNP type DS558 or similar small signal type.

- Miscellaneous:** One 9 volt battery and battery clip
Two lengths insulated hook-up wire approximately 10cm long.
One length insulated hook-up wire approximately 3cm long.
18 self-tapping screws and washers
7 lengths tinned copper wire.
One 8 ohm loudspeaker.
Baseboard and project overlay

- As with the previous projects, cut out project overlay No. 11 and glue it to your baseboard. After inserting the screws and washers, assemble the circuit as per the overlay and layout drawings.
- Check that all your components are properly screwed down, and check polarities. In this circuit, **all** components with the exception of the speaker, resistor and potentiometer are polarity conscious – so make sure they are all correctly installed.
- The wire link passing under the electrolytic capacitor should be insulated to avoid short circuits.
- This is the first project to use a potentiometer. It is mounted by fastening its three terminals under the washers. The shaft of the potentiometer can point straight up from the board, or you can bend the potentiometer terminals through 90° to have the shaft parallel to the baseboard.
- The loudspeaker is not screwed to the board – it is connected via insulated hook-up wire. If you've forgotten how, refer to the section earlier in the book on how to make your projects a success.
- Connect the battery to the battery clip. You should be greeted by any one of a variety of noises – depending on the setting of the potentiometer. Vary the potentiometer, and you vary the sounds.

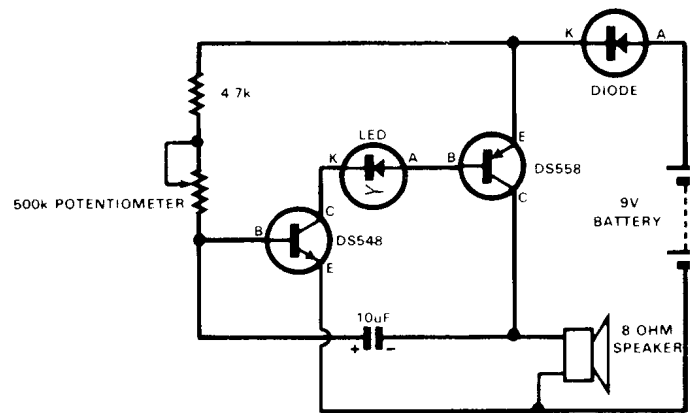

Figure 1

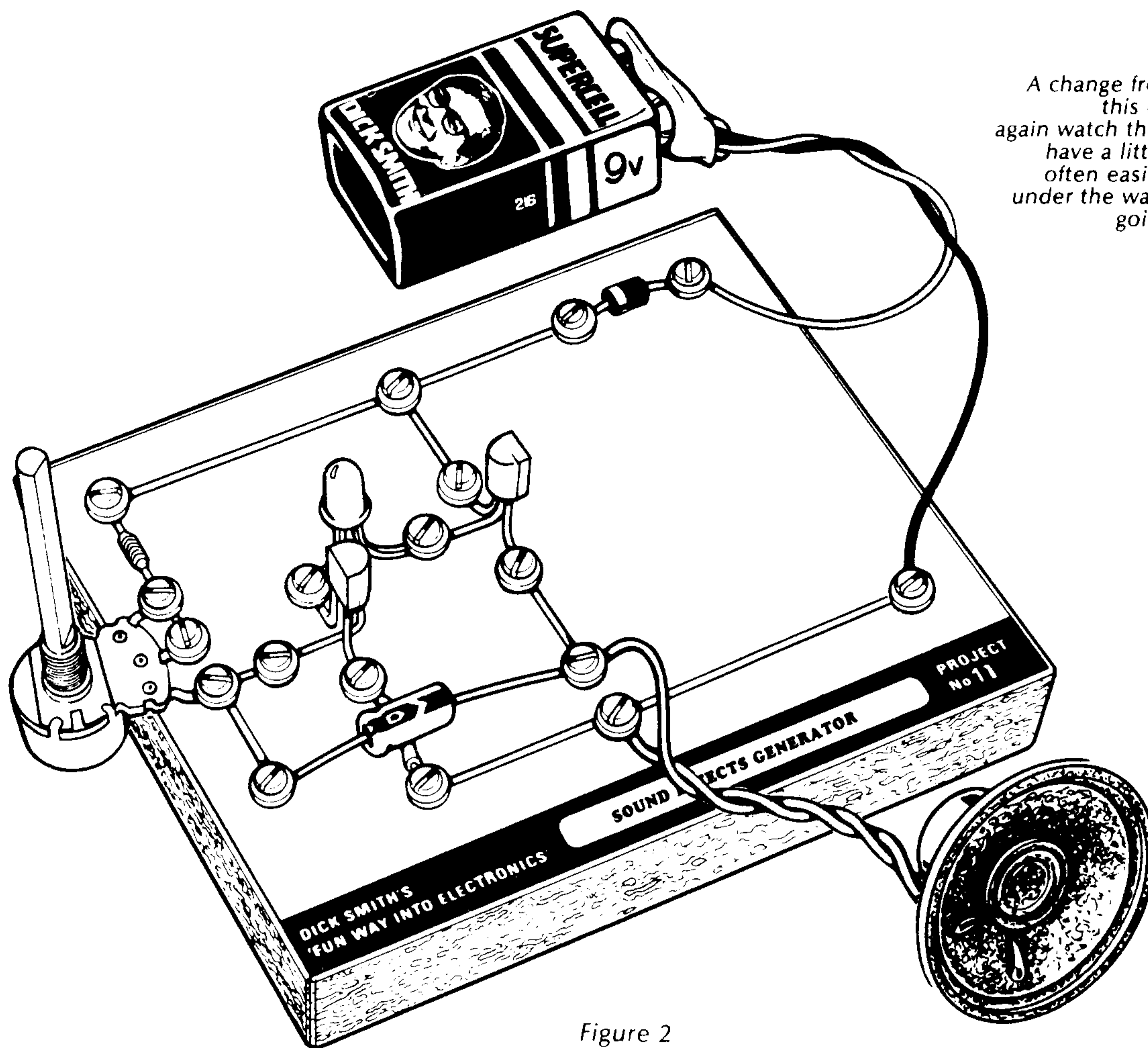

Figure 2

A change from the multivibrator circuits: this one is fairly simple, but once again watch that PNP transistor! You might have a little trouble with the pot – it is often easier to make the terminals fast under the washer, but not have the screw going actually through the hole.

In many ways, this project functions in the same way as does the siren in project 6. The main difference is that a single capacitor is used for feedback and to switch the transistors.

Current flows from the positive battery terminal, through the resistor and potentiometer, charging the capacitor. Eventually the capacitor is charged enough to allow the transistor to turn on.

When this happens, the capacitor discharges through the base/emitter of the transistor. As the charge in the capacitor decreases, the transistor turns off and the cycle starts all over again.

As the first transistor turns on and off, it causes the second transistor to turn on and off. The LED lights and the speaker emits a 'click'. The sound varies as the time taken to charge the capacitor varies. This is controlled by the setting of the potentiometer.

With a little practice, you will be able to control the potentiometer to obtain the sounds – and more – listed above. To make even more sounds, try replacing the potentiometer with a light dependent resistor (LDR). Use the two terminals for the potentiometer that are not connected by a wire link.

Vary the amount of light reaching the LDR and you'll be surprised at the results. Try waving your hands between the LDR and light for some really eerie effects!

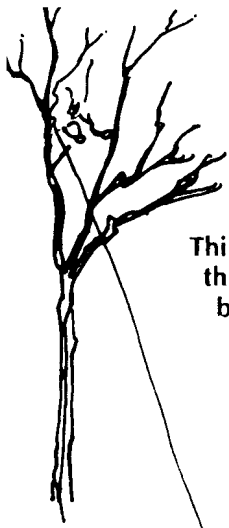

A crystal set

This project is the ultimate in energy conservation: all the power used by this radio is free power from the airwaves: you never need to buy a battery!

First built by the pioneer radio experimenter Guglielmo Marconi some 70 years ago, and despite incredible advances in technology, this is still the simplest radio receiver. It will virtually work forever and all the energy it uses is supplied by the radio station to which it is tuned!

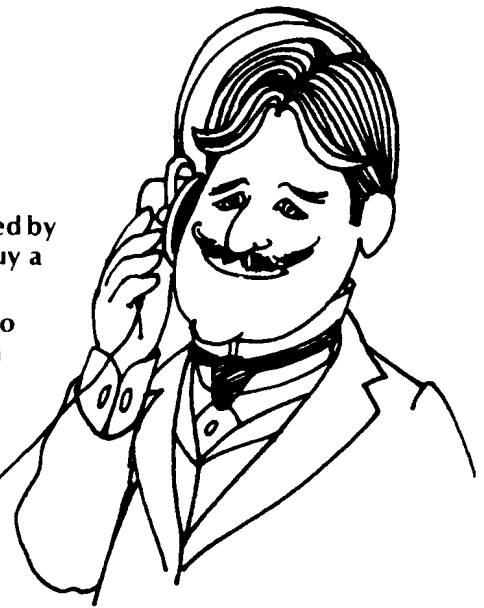

Resistors:
Capacitors

None
One 0.01uF disc ceramic
One 60 to 160pF variable
One signal diode OA91 or similar

Diodes:

Miscellaneous:

One ferrite rod aerial
One crystal earphone
Wire for antenna and earth connections
11 self-tapping screws with washers
Baseboard & project overlay No. 12

- (1) This project is very simple and easy to build –even the diode, which is normally polarised, can be put in back to front and it will still work! Take care, however, with the wires from the ferrite rod aerial: these are important.
- (2) We use only two terminals of the variable capacitor to actually connect it into the circuit. These may be labelled 'A' & 'G'. The third terminal (which may be labelled 'O') is used only to help hold the capacitor in position.
- (3) You will probably need to scrape some of the enamel insulation from the wires on the ferrite rod aerial. **Very** carefully scrape with a sharp knife or single-edged razor blade. Be careful not to scrape too hard as these wires are very thin and will easily break.
- (4) The success of this project depends to a large degree on a good aerial and earth (the terms 'aerial' and 'antenna' usually mean exactly the same thing.) The more signal you can collect from the air the better your crystal set will work.

A basic rule for a broadcast band or short wave receiving antenna is 'as high and as long as possible'. Your antenna, then, can be any type of wire, insulated or not (although insulated wire is often preferred because it is less likely to corrode). If you have a tall tree, pipe, mast, or other object onto which you can fasten your

antenna, all the better. You'll find more about antenna construction in the section at the back of this book 'About radio transmission and reception'.

- (5) As we mentioned, the crystal set also needs a good earth. The cold water pipe is normally a very good earth, as it runs for long distances in the ground and makes intimate contact with it (hot water pipes may not run to earth). You can connect to the cold water pipe by removing 10 to 15cm or so of insulation from a piece of hook-up wire, winding the bare wire tightly around the pipe and finally tying a knot to keep it secure.
Do not use a gas pipe for an earth. It is dangerous and illegal.
If you cannot use a cold water pipe for an earth, you can make a reasonable earth by driving a steel or copper rod at least one metre into the ground (preferably somewhere it is damp) and connecting your earth wire to that. Take care there are not pipes or cables underground which you could damage!
- (6) Connect your antenna, earth and earphone to the points shown on the circuit overlay. By varying the tuning capacitor you should be able to tune the different radio stations in your area.

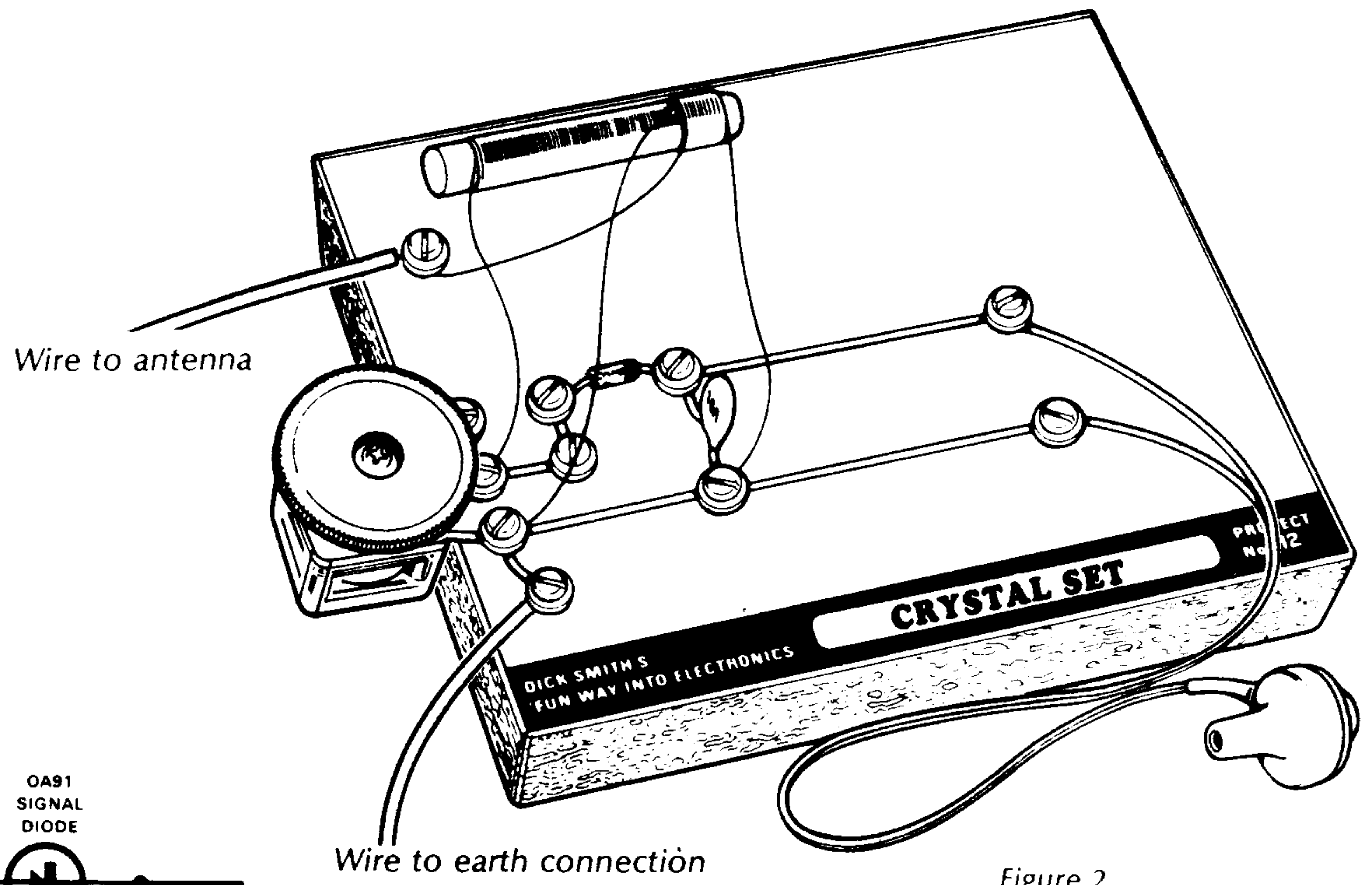

Figure 2

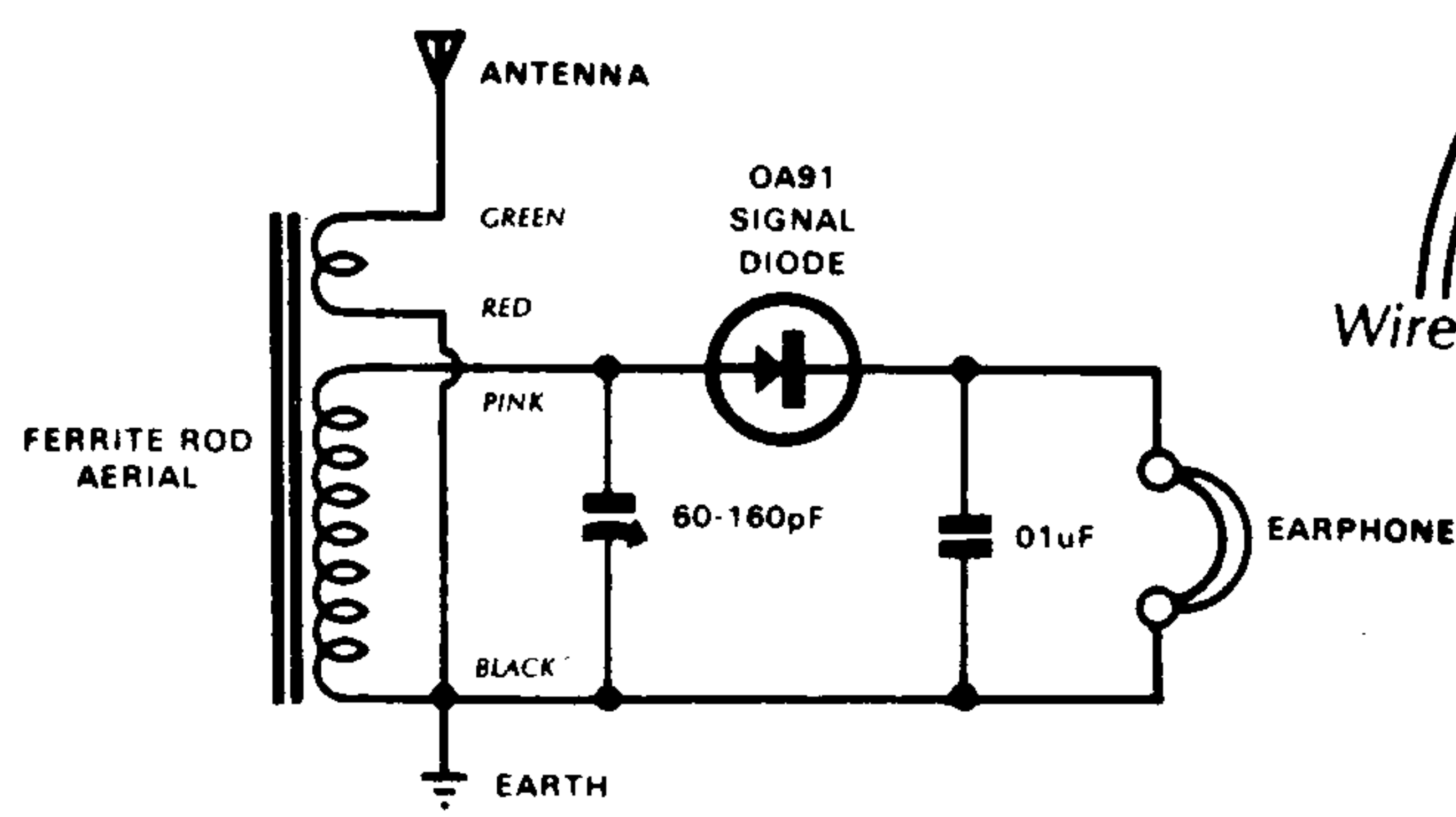

Figure 1

For a detailed explanation of radio reception and transmission, refer to the last chapter of this book.

In our crystal set, the "crystal" is very tiny and mounted in the glass envelope of the diode along with its 'cat's whisker' wire. But it is basically just a modern day version of the original crystal and cat's whisker wire used by Marconi.

The radio waves in the air cause small electric currents to flow in the antenna wire. This is coupled into the coil and tuning capacitor which, between them filter out the desired station frequency from all those received by the antenna.

The single station radio frequency current passes through the diode which changes it into a form which can be used by the headphone.

Thus the crystal set takes all its signal from the air, and converts the wanted signal into sound: free power!

After a little practice, you will be able to tune stations with relative ease. You may care to make a small dial and attach this to your tuning capacitor to show where the stations are and make tuning easier.

A little experimentation with antenna and earth connections may improve your results. What you will pick up depends on the stations in your area – you should be able to receive stations in a radius of, say, 50km from your home – **providing your antenna and earth are adequate!**

Further improvements to your crystal set may be made by building add-on projects: Nos. 13 & 15 describe transistor amplifiers which amplify the sound from your crystal set: Project 20 describes a radio frequency amplifier which you connect between the antenna and the antenna terminal of the crystal set to increase the level of radio signals received from the air.

The only trouble is – they work from a 9 volt battery – so you lose the 'free radio' feature!

Before we finish this project, a word of warning: NEVER use, as an earth connection, the 'earth' pin from a household power outlet. The earth in a mains power system is there for your protection, and should a fault develop while you are using your crystal set, etc, YOU MAY NEVER GET THE CHANCE TO BUILD ANOTHER PROJECT!

A one transistor amplifier

This is a simple one transistor amplifier that can boost the output of your crystal set, giving more volume into your earphone

You can also use this amplifier with several later projects.

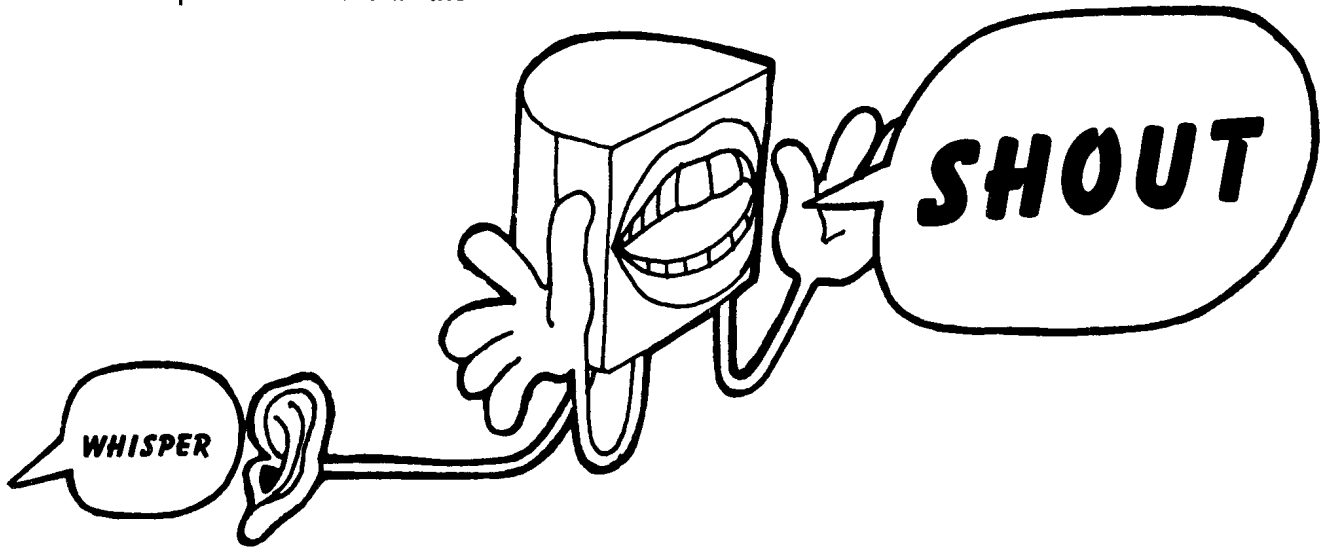

Resistors:

One 1.2k ohms (brown - red - red)
One 100k ohms (brown - black - yellow)

Capacitors:

One 10uF 16 volt electrolytic type

Transistors:

One NPN type DS548 or similar

Diodes:

One protection diode, 1N4001 or similar

Miscellaneous:

One 9 volt battery and clip
One crystal earphone
Four lengths of tinned copper wire
Two 12cm lengths insulated hook-up wire
13 self-tapping screws with washers
Baseboard & project overlay No. 13

- (1) You should have no problems with this project. Everything is straightforward, with no cross-overs to worry about. Just be careful, as usual, with polarised components (diode, transistor & capacitor.)
- (2) Connect the 12cm insulated hook-up leads to the input terminals. Connect a battery to the clip, and listen to the earphone. If you touch the input leads together, you should hear the earphone 'click'. If so, your amplifier is ready to use.

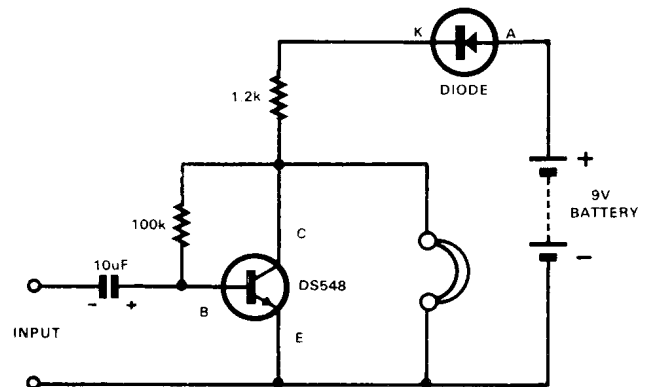
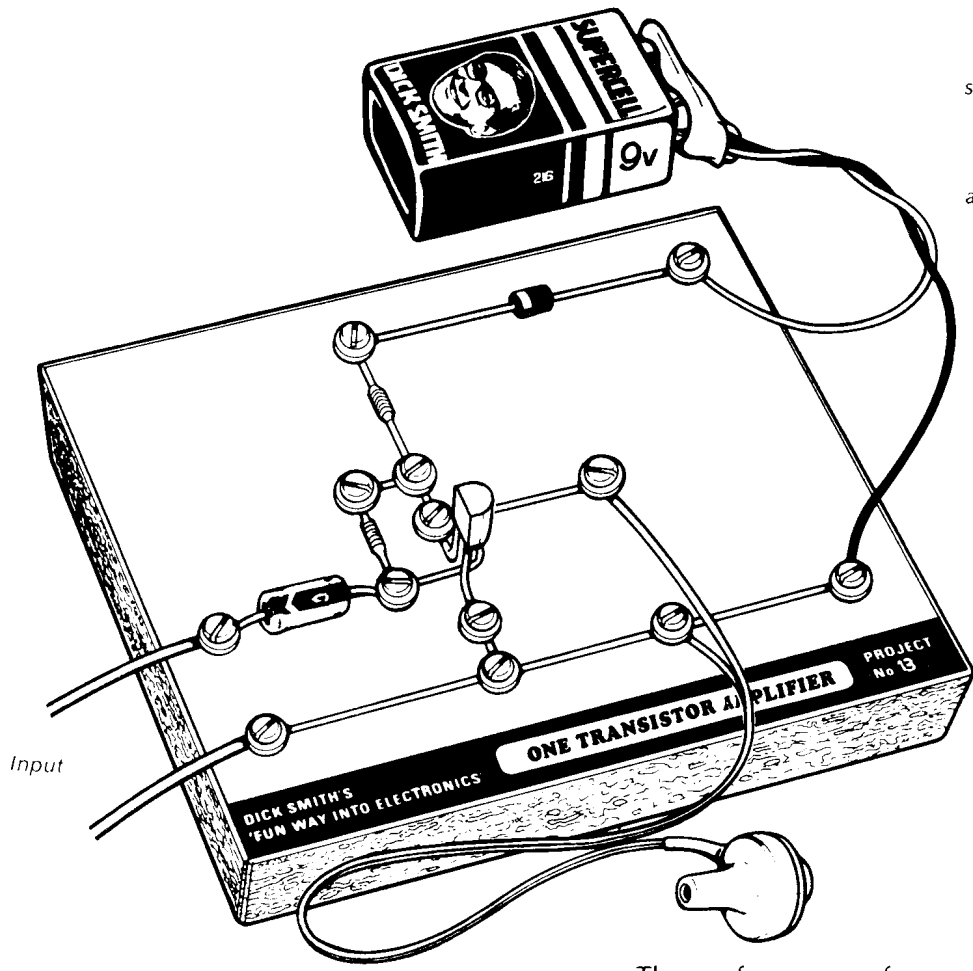

Figure 1



Simplicity itself! However, this project should allow better volume levels into your earphone than does the basic crystal set.

This project can also be used in conjunction with the two transistor amplifier for even better performance.

Figure 2

This circuit is about the simplest transistor amplifier circuit you can make. Small audio frequency currents flow into the base of the transistor, resulting in larger audio signals flowing through the collector (an amplified version of the input signal).

A crystal earphone is connected between the collector and the negative supply. This earphone is, as you may remember, very high resistance, so it does not alter the operation of the transistor. But it does respond to the varying voltage levels across it (the voltage varies as the collector current varies) and it turns the varying voltages into sound waves which you can hear.

The performance of your crystal set can be greatly improved by placing the audio amplifier between the crystal set output and the earphone, as shown in fig. 3.

In actual fact, we are not improving the crystal set sensitivity, rather we are amplifying signals which the crystal set can normally pick up anyway, but are too weak for us to hear.

This circuit can also be connected as a simple intercom by connecting a crystal microphone (or another crystal earphone used as a microphone – see how in the 'components' section) to the input. You should find that communication between rooms is possible by lengthening the microphone (or input) leads. If you make two of these up, you will have a simple telephone!

Calling each other is no problem: make a couple of code communicators and you have a buzzer with which to call the other party to the 'phone'.

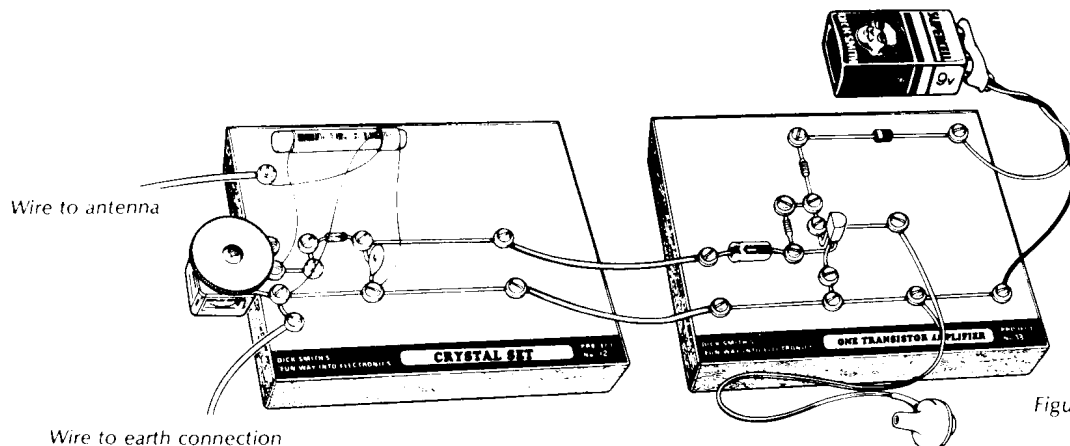
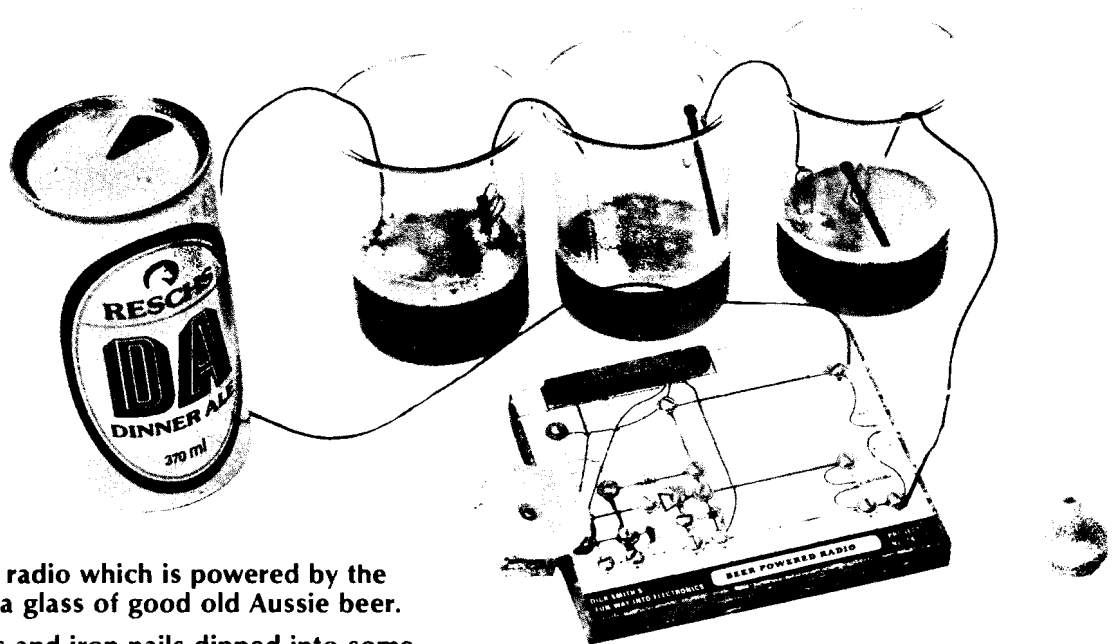

Figure 3

A beer powered radio!



It had to happen – a radio which is powered by the energy contained in a glass of good old Aussie beer.

A few two cent coins and iron nails dipped into some glasses containing a small amount of beer causes a chemical reaction, producing enough electricity to run a simple radio receiver.

And just in case no-one in your family drinks beer, we'll show you how to use a battery to replace the beer 'power cell'.

FOR THE RADIO RECEIVER ITSELF:

Resistors: One 100k ohm (brown - black - yellow)
Capacitors: One 0.1 μ F disc ceramic
 One 0.01 μ F disc ceramic
 One 60 to 160pF variable type
Semiconductors: One ZN414 integrated circuit
Miscellaneous: One ferrite rod aerial
 One crystal earphone
 19 self-tapping screws with washers
 Baseboard & project overlay No. 14

BEER POWER CELL:

Three glasses and one can or bottle of beer
 Three two cent coins
 Three iron nails 5cm long
 Six paper clips
 Four 25cm lengths of insulated hook-up wire

ALTERNATIVE (BATTERY) POWER SUPPLY:

One 33k ohm resistor (orange - orange - orange)
 One protection diode, 1N4001 or similar
 One 9 volt battery and battery clip

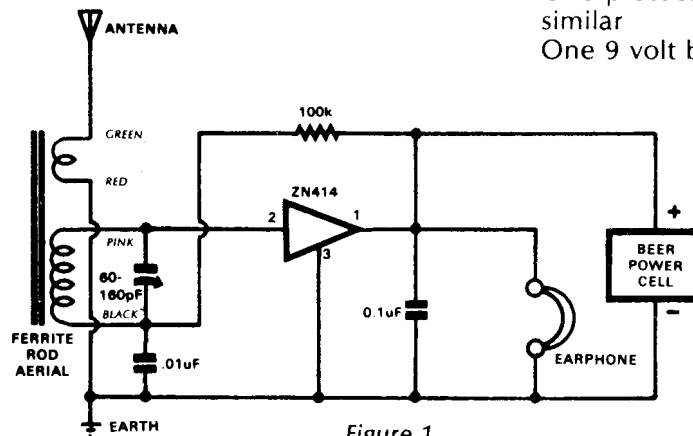

Figure 1

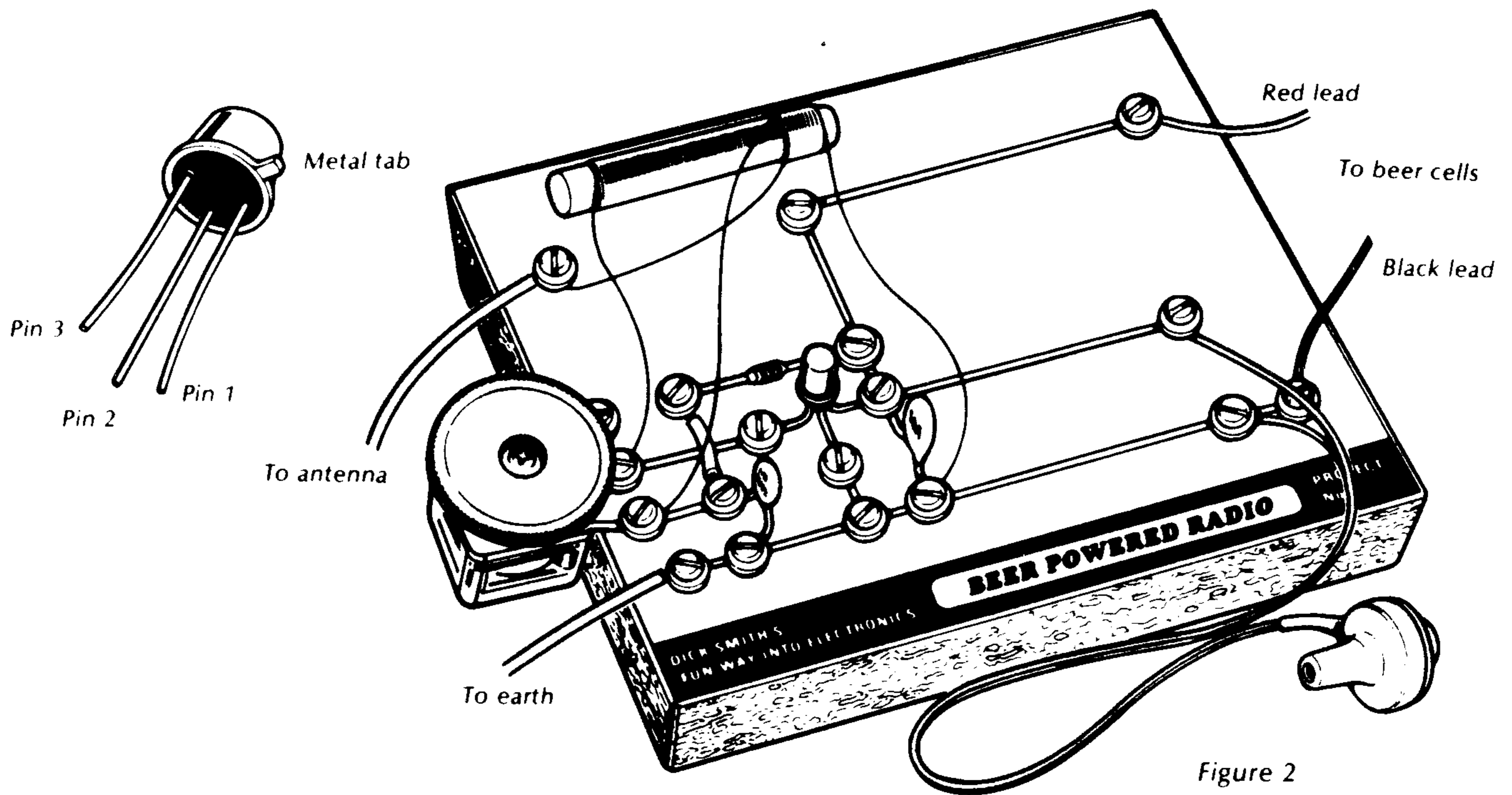

Figure 2

- (1) Construct the basic board as shown on the overlay and layout diagram. Be careful with the integrated circuit connections: refer to the diagram showing which pins go to which points. Also make sure that none of the leads of the integrated circuit are touching one another or the metal case.
- (2) Check that the four ferrite rod connections are made as shown in the overlay. Remember they may have a thin coating of insulation over the wire that has to be removed for good connection.
- (3) Depending on your location, you may need an external aerial and earth as described for the crystal set (Project 12).

- (4) Note that no protection diode has been included in this circuit. This is to ensure that all power produced by the beer cell is available (a diode would waste a little of this). So make sure you don't mix up the connections to the beer power cell!
- (5) The radio section of this project should now be ready for operation. All we need now is some power!

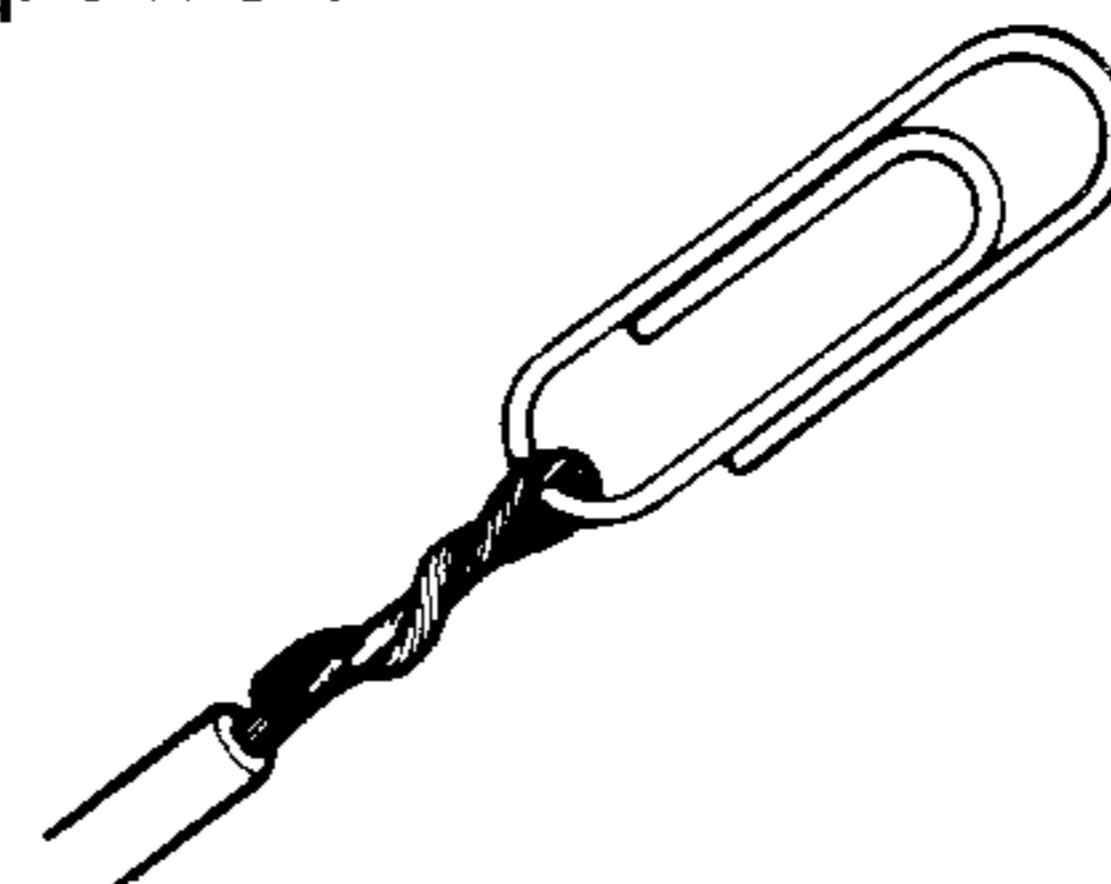

Figure 3

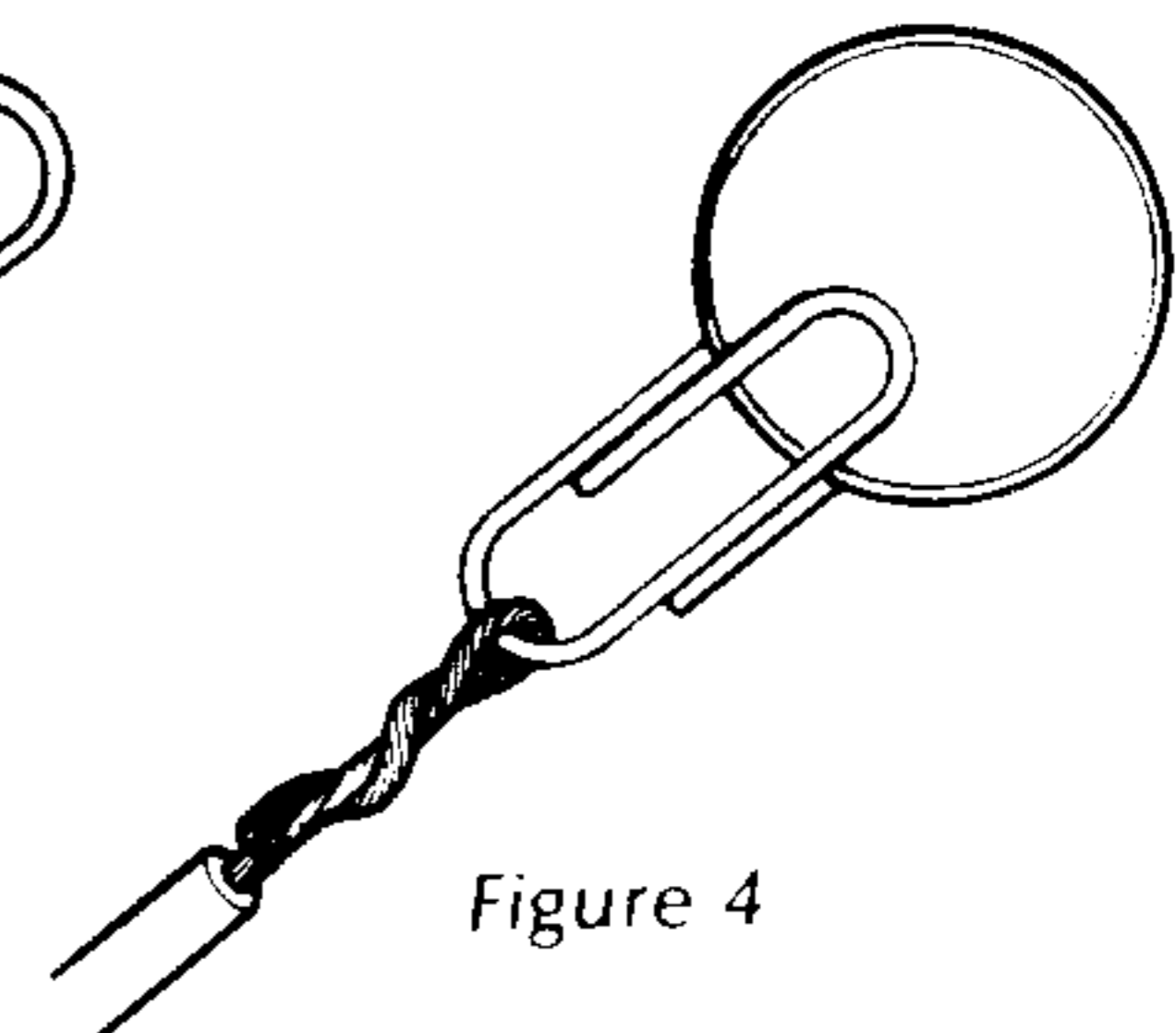

Figure 4

- (1) Get everything ready before you open your bottle or can of beer, to ensure it does not lose any of its 'fizz' before you are ready. This step also ensures there is enough beer left over to make the power cell!
- (2) Take the four lengths of insulated hook-up wire and remove approx. 4cm of insulation from each end. Twists the strands of wire together then wrap them around and around each of the four paper clips (one clip per end of wire!) as shown in fig. 3.
- (3) The nails, coins and paper clips must be very clean to work properly. If the nails are not shiny bright, clean them with some emery cloth or scrape them with an old knife. If the coins are tarnished, clean them with a little toothpaste on a cloth. This cleaning is necessary to ensure good electrical contact with the beer.

- (4) Clip a nail onto paper clips one, three and five. Onto the remaining clips (two, four and six) clip your shiny two cent coins as shown in figure 4.
- (5) Half fill your glasses with beer. Keeping all the coins and nails on the clips, lower them into the beer. Clips one and two go in the first glass, three and four in the second glass, five & six in the third glass.
- (6) Try not to let any of the paper clips touch the beer. If you do, the power available from the beer cell will be drastically reduced. Submerge only as much of each coin and nail as you can without getting the clip wet. Hold the coins and nails in the right place by bending the wire sharply back over the lip of the glass.

Continued overleaf . . .

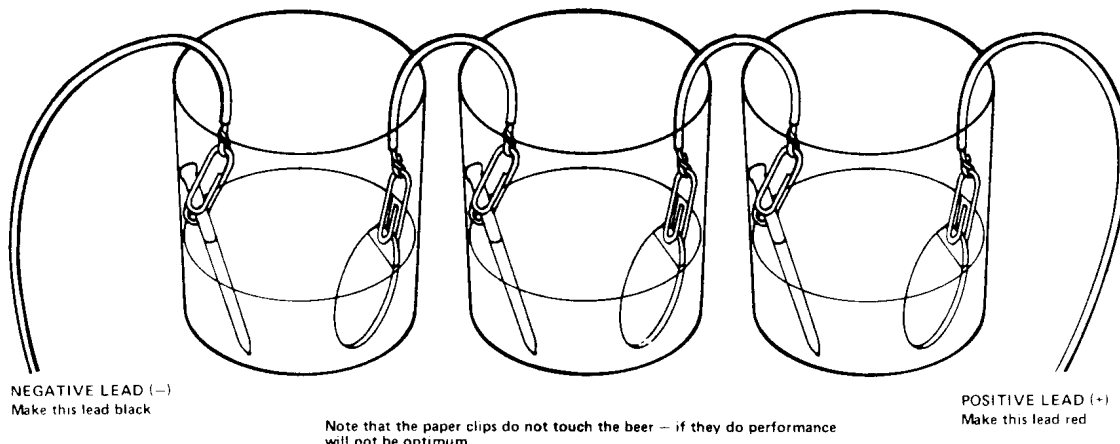

Figure 5

- (7) Make sure that the coin and nail in each glass are kept at opposite sides of the glass. Do not allow them to touch.
- (8) The three beer glasses now form three power cells connected in series. Figure 5 shows the polarity of this supply – the copper coins are the positive (+) side and the iron nails the negative (-). Connect the beer cells to your integrated circuit radio as shown in figure 5. Maximum energy is reached after about one minute. Listen in on the earphone and you should be able to tune radio stations in your area. If not, try an antenna and earth as mentioned previously.
- (9) When the bubbles in the beer disappear or the volume drops, it is time to replace the beer with a fresh brew.

- (10) You can get better performance by adding a fourth, even a fifth beer cell in series with the rest. Simply duplicate one of the other beer glasses, keeping the polarities the same. Do not exceed five glasses, however: the voltage developed by the beer cell may exceed the safe operating voltage of the integrated circuit and damage could occur to it.
- A reminder that the polarity diode has been omitted – so check positive and negative leads before any connection is made.

NOTE: Do NOT drink the beer after use. Apart from the fact that it will taste really horrible, it could be poisonous because it has been in contact with copper. Throw the beer out immediately you have finished using it!

The beer powered radio makes a great project and certainly proves the point that you don't need battery power, but it may be a little impractical to listen to it while keeping up the supply of beer. It can also be operated from a conventional battery with the addition of a couple of components.

Figure 6 shows the components required: one resistor and the protection diode, plus battery.

The hole positions are marked on the overlay for these additional components.

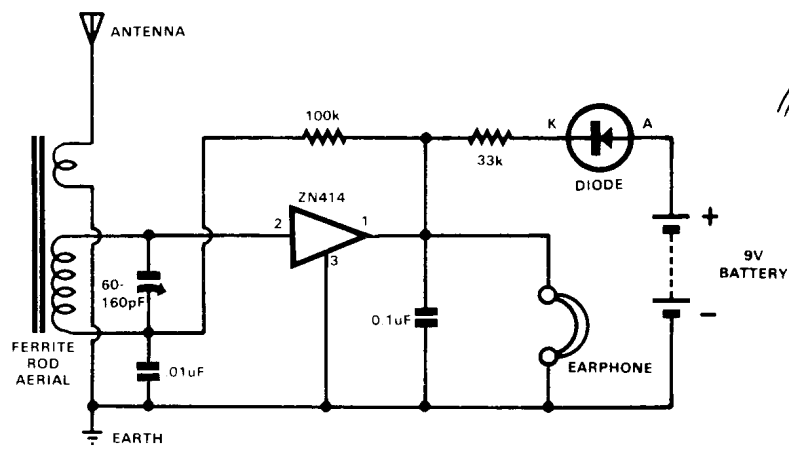

Figure 6

The beer-powered radio modified for battery use. The two ringed components are all that are required.

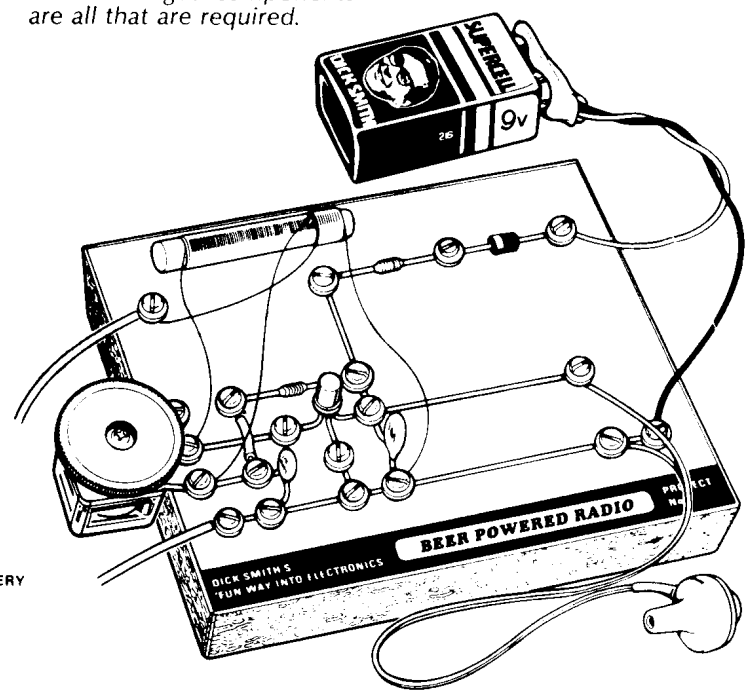

Figure 7

There are a number of modifications and experiments you can try with the IC radio, but to gain most benefit you should first build project 15 – a two transistor amplifier. This will allow you to listen to the radio without needing an earphone.

The first modification is an easy one – it will allow you to hear stations below the bottom end of the broadcast band. The stations on these frequencies (below 530kHz – kHz means kilo Hertz) are mainly coastal radio stations, and the international Morse Code distress frequency – 500kHz.

All you do to hear these stations (if there are any in your area) is place another ferrite rod aerial alongside the existing one, without actually making any connections to it. (See figure 8).

Placing this rod close to the other acts as if we are placing more turns on the rod, without actually doing so. And more turns on the rod means the set covers a lower frequency.

By rotating the rods, you should find signals stronger in some directions than in others. There should be some stations to listen to with the tuning capacitor nearly as far anti-clockwise as it will go.

Regular listening will soon familiarise you with the stations transmitting on this band.

To drop the frequency even further, the second coil must be actually connected to the first. See figure 9: this shows two methods you can try.

After modification, you should be able to tune from around 270kHz with the tuning capacitor in the anti-clockwise position, to around 800kHz in the clockwise position. On this band are the morse code beacons which transmit two or three letters 24 hours per day to enable ships and planes to pinpoint their positions. By now you should have a reasonable knowledge of Morse code: try to identify the stations from their letters – the transmissions are fairly slow. For example, Sydney transmits 'SY' (di di dit dah di dah dah); Brisbane sends 'BN' (dah di di dit dah dit).

Just as we can extend the range downwards by connecting a ferrite rod in series (adding **more** turns), we can extend the range upwards by connecting a ferrite rod in parallel (effectively **removing** turns).

Figure 10 shows how to do this.

Your radio should now tune approximately 900kHz anticlockwise to around 2600kHz (or 2.6MHz) clockwise.

On this band, there are a number of interesting stations. First of all, just above the broadcast band on 1750kHz is the university radio station VL2UV – listen for it in the evenings. This frequency may be different in states other than New South Wales – ring the local university and see if they have a station. Above this, 1800 to 1860kHz (1.8 to 1.86MHz) is the first amateur band – listen for amateur radio broadcasts each

evening and a special news broadcast on Sunday morning on 1825kHz. There is also the international 'voice' distress frequency on 2182kHz (2.182MHz).

It is possible that the receiver will break into unwanted oscillations – sounding like a motorboat – when you connect the second ferrite rod in parallel or series. If this occurs, refer to the final paragraph in project 15 for likely cures.

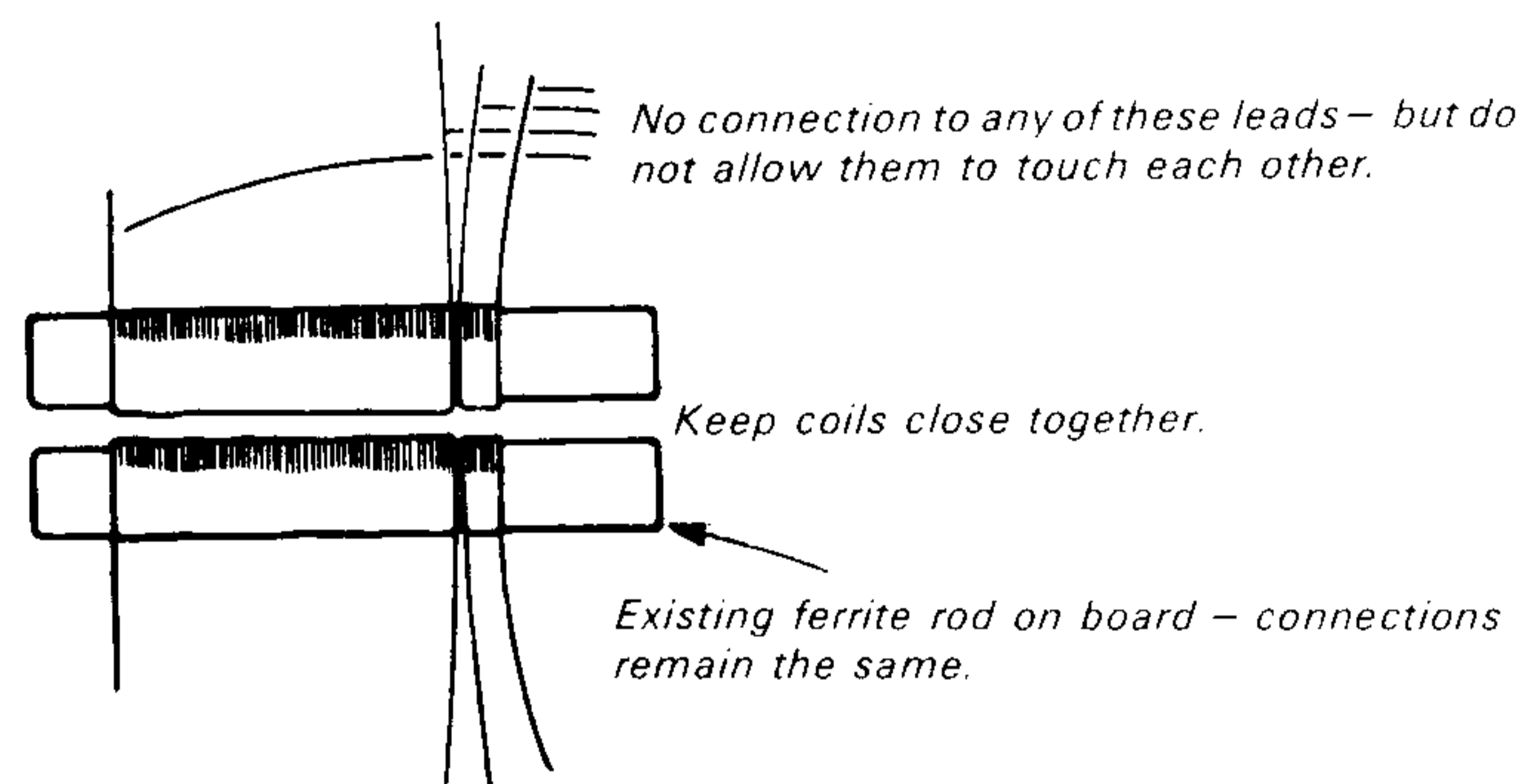
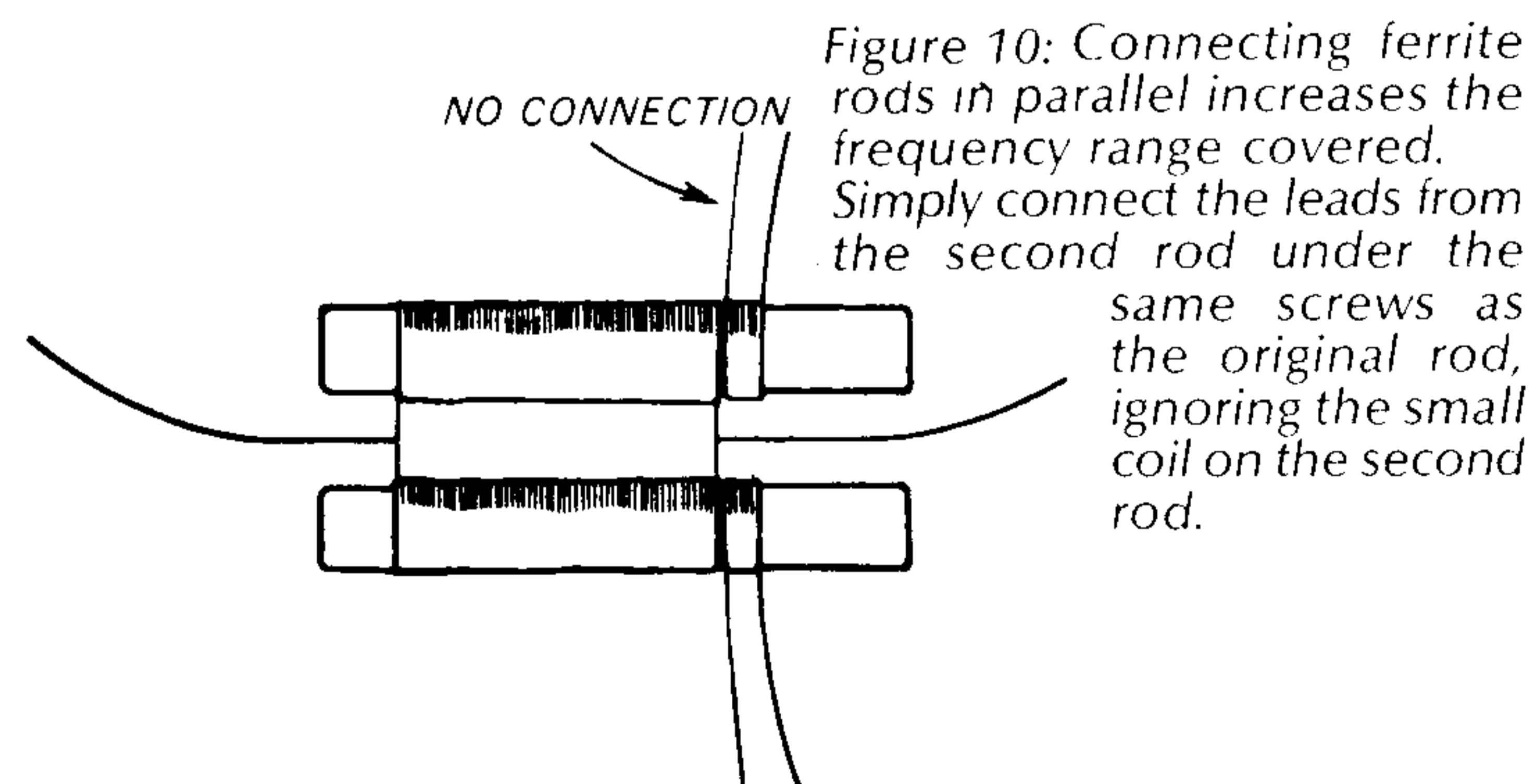
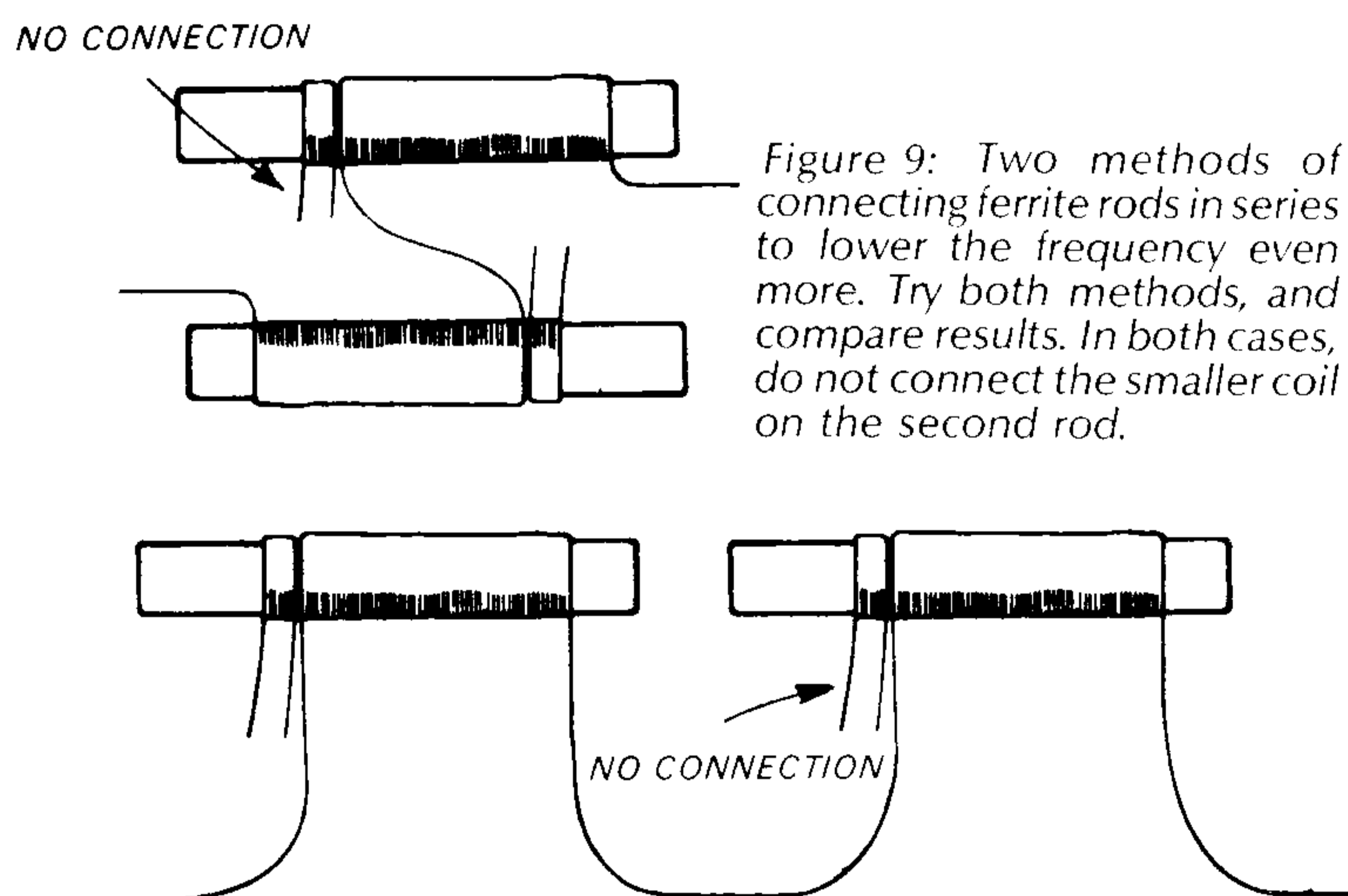
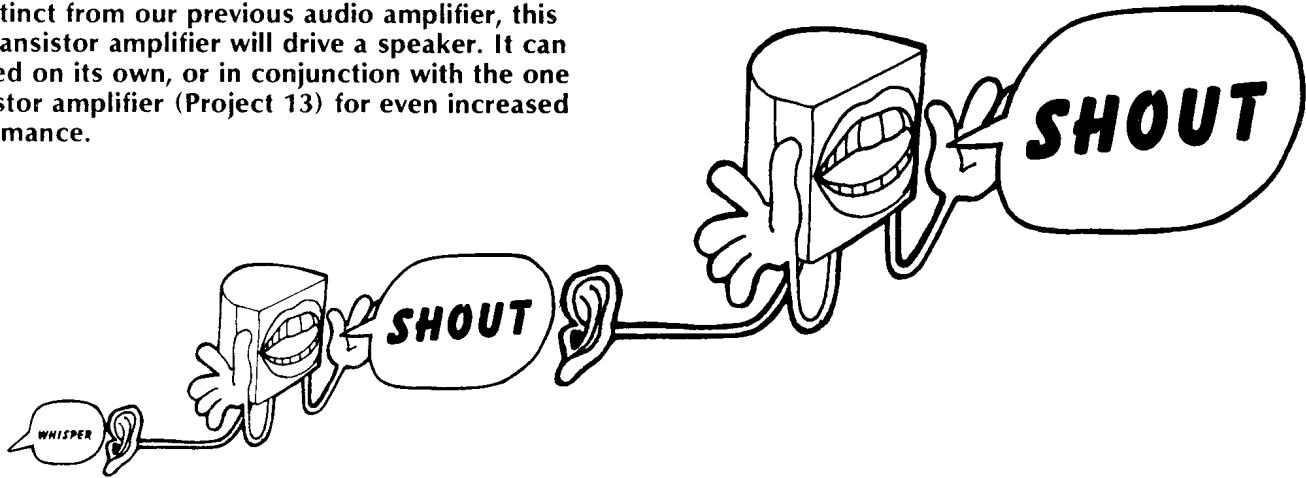

Figure 8: Placing a second ferrite rod alongside the existing ferrite rod, as shown, will slightly lower the frequency band this receiver will cover. It is easiest to tape the second rod on the board, alongside the existing rod.



A two transistor amplifier

As distinct from our previous audio amplifier, this two transistor amplifier will drive a speaker. It can be used on its own, or in conjunction with the one transistor amplifier (Project 13) for even increased performance.



Resistors:	One 1.2k ohms (brown - red - red) One 100k ohms (brown - black - yellow) One 470k ohms (yellow - violet - yellow) One 500k potentiometer (variable resistor)
Capacitors:	One 0.047uF greencap One 0.047uF disc ceramic Three 10uF, 16 volt electrolytic
Diodes:	One protection diode (1N4001 or similar)
Transistors:	Two NPN type DS548 or similar

Miscellaneous:	One 9 volt battery and battery clip One 8 ohm loudspeaker One audio transformer 8 ohm to 1k ohm. Ten lengths tinned copper wire Two 10cm lengths insulated hook-up wire Two 20cm lengths insulated hook-up wire 28 self-tapping screws with washers Baseboard & project overlay No. 15
-----------------------	---

- (1) This is probably our most complicated project to date, so take care when assembling all the components. There is a new component – the audio transformer– in this project. You can easily identify the connections as one side has two leads and the other three. Note how it is placed on the project overlay and layout drawings (the middle lead on one side is not connected to any point on the circuit board).
- (2) Use the 10cm leads to connect the speaker as you have done in previous projects. The 20cm leads can be used to connect to the input. When you are sure everything is ok, turn the potentiometer fully clockwise, connect the battery to the clip and short the input leads together. The speaker should make a clicking sound when you do this. When you turn the potentiometer fully counter-clockwise, shorting the input leads would not result in any sound coming from the speaker.

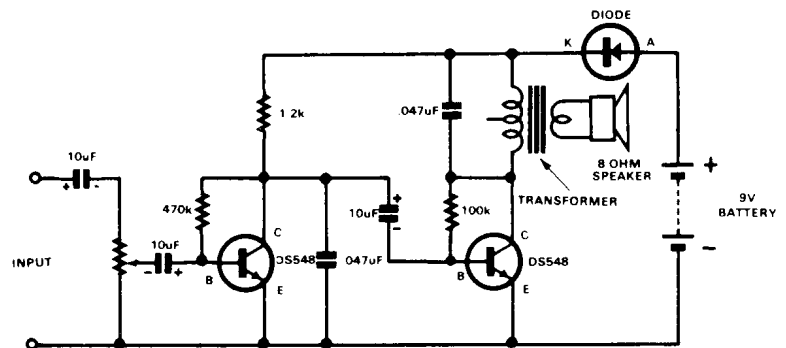

Figure 1

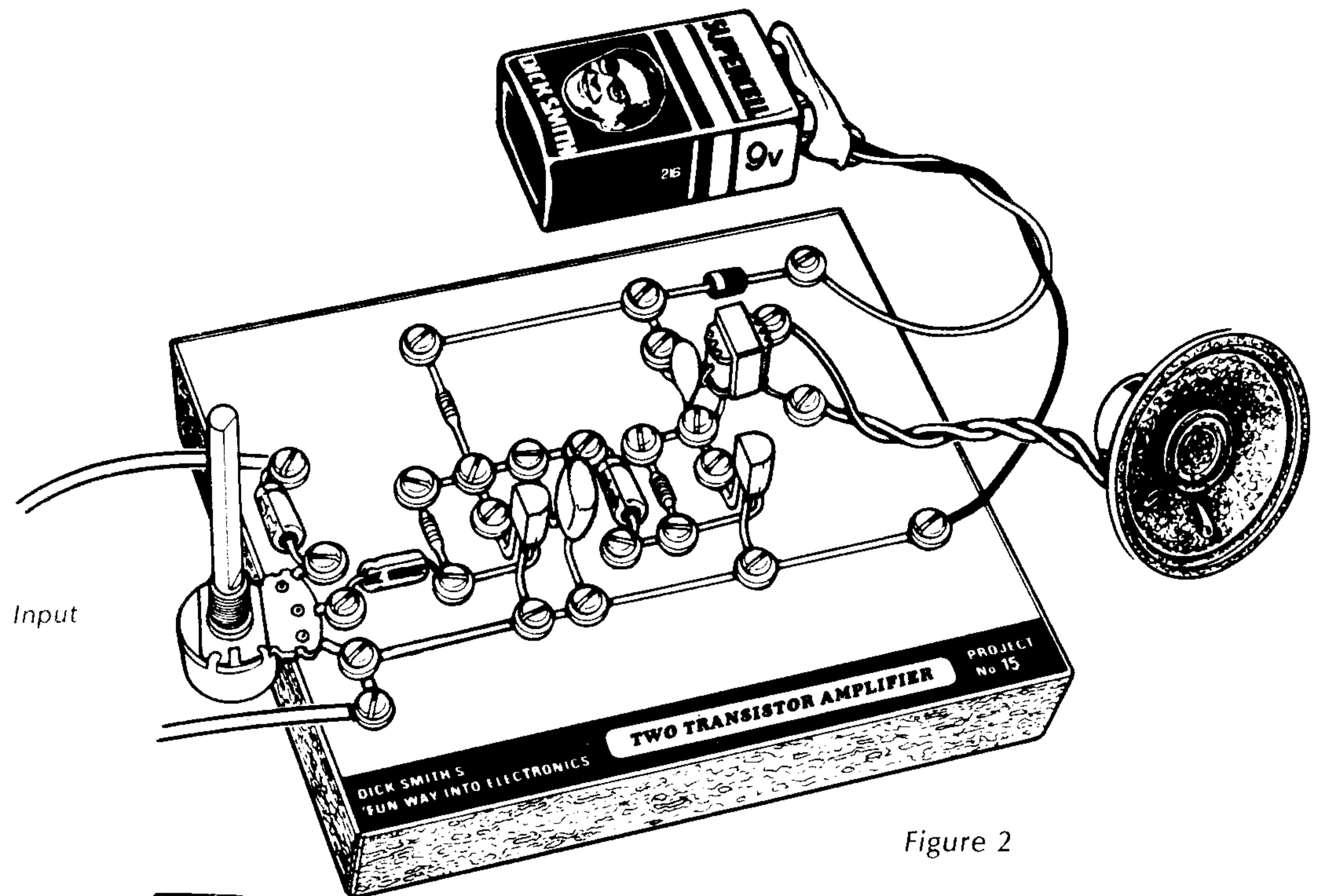

Figure 2

The amplifier can be connected directly to the beer powered radio (or IC radio) or the crystal set so that a speaker can be used instead of an earphone.

Alternatively, for even better performance, you can use **both** the one transistor and two transistor amplifiers, as shown in figure 3

If you want to amplify your voice, connect a crystal earphone to the input and use as a microphone (as explained previously). Speak into the 'microphone' and you should hear your voice coming from the speaker.

If you wish to amplify any of the multivibrator projects that used a speaker (projects 6, 7, 9, 10 & 11) an audio matching transformer is needed to couple the multivibrator to the amplifier. This is shown in figure 4, – don't forget to take the existing speaker out of the circuit. Note that in all cases the 8 ohm side of the transformer (two leads) connects to the 'speaker' terminals, while the 1k ohm side (three leads; use only the outer two leads) goes to the input of the amplifier.

In some cases, because of the variety of components being used, oscillation may occur. This may sound as 'burping' noises, or like a put put motorboat, etc. Oscillation can usually be cured by one of the following methods:

- (1) Connecting a 0.047uF greencap capacitor across the input to the two transistor amplifier.
- (2) If not successful, try the same capacitor across the input of the one transistor amplifier.
- (3) In the worst cases, you might need a 0.047uF capacitor across both inputs. In some cases, though, adding this capacitor might actually cause oscillation, where it would not normally occur – so it is not shown as part of the normal circuit.

This amplifier is very similar in operation to the one transistor amplifier: the difference is, obviously, and extra transistor which amplifies the signal even further. Also, there is a volume control which allows us to vary the amount of signal we feed into the transistor – and therefore the volume from the speaker.

Weak signals are amplified by the first transistor, then further by the second transistor. Between the positive supply and the collector of the second transistor is an audio transformer. Any current flowing through the collector of the transistor also passes through this transformer. Signals are transferred from the 'primary' side of the transformer (the side connected between positive and collector) to the 'secondary' side. This transformer feeds the speaker audio frequency current at a level which can drive it. The speaker converts the audio current into sound.

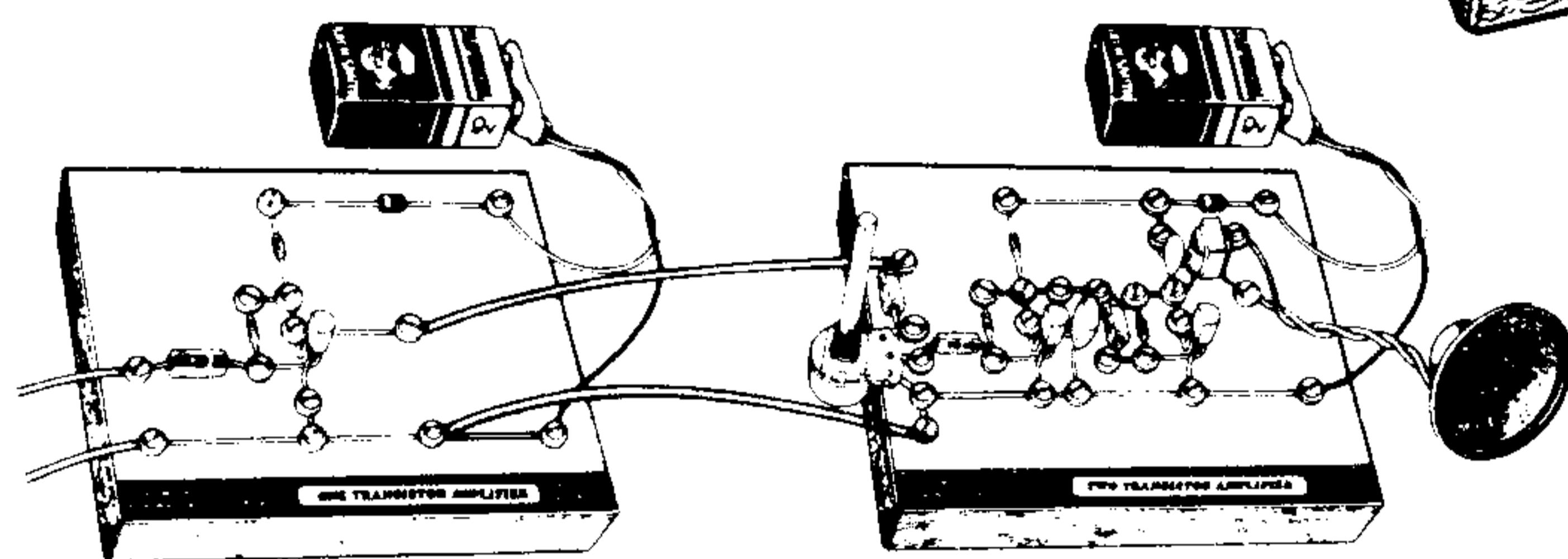

Figure 3

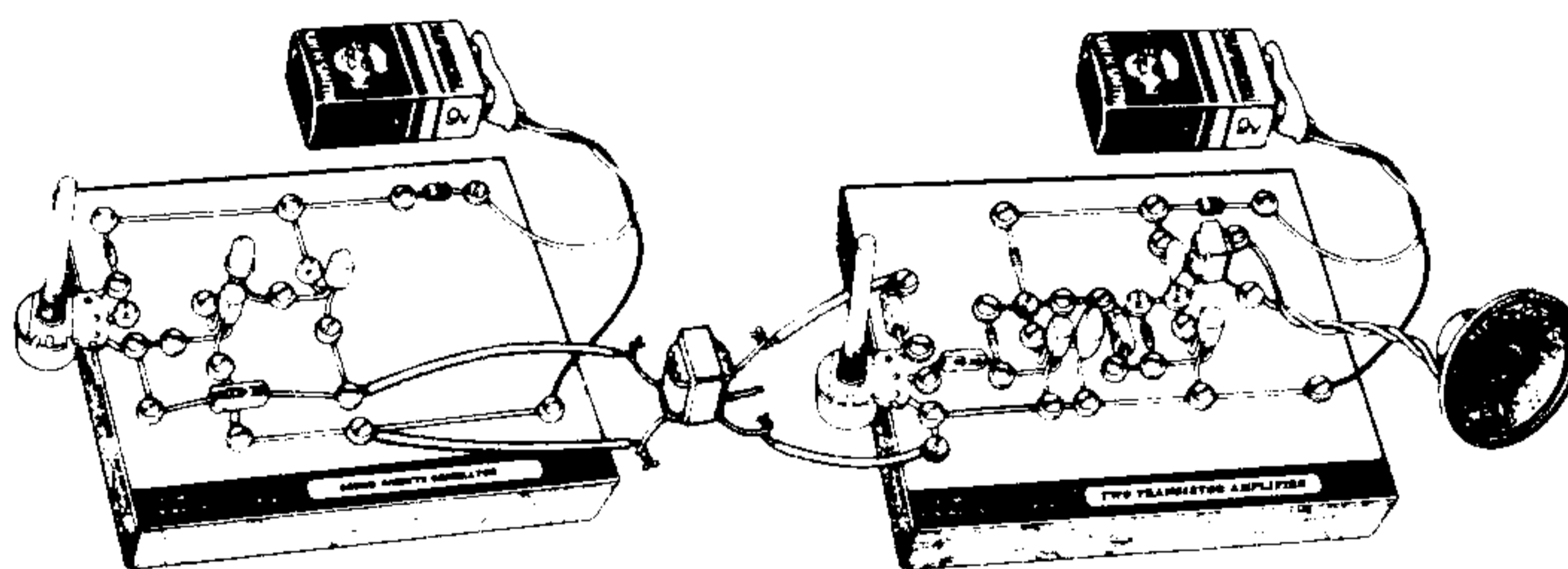
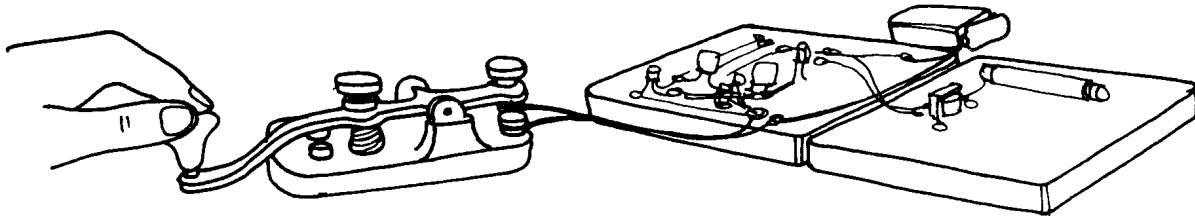

Figure 4

The world's simplest transmitter

By using the code communicator in Project 9, only two extra components are needed to build a transmitter which will broadcast Morse code. You should be able to pick this transmission up on virtually any radio receiver over a distance of a few metres.

Using a simple transmitter with a crystal set receiver, Marconi made the first radio transmissions over a few metres when he was just 17 years old!



Miscellaneous: One audio matching transformer, 8 ohm to 1k ohm.
One ferrite rod aerial
Five self-tapping screws and washers
Baseboard & overlay for project 16.

- (1) This project is so simple, it hardly seems necessary to say anything about construction. Just note the orientation of the transformer (the two lead side is the input side) and the connections to the ferrite rod aerial.
- (2) Remove the speaker from the Morse code communicator and in its place connect the pair of insulated hook-up wires. Connect these to the input of the transmitter.
- (3) Connect the battery to the code communicator and keep the Morse key pressed down.
- (4) With the transmitter next to your crystal set or other radio receiver vary the tuning dial until you hear the loudest tone. This will probably be near the anti-clockwise end of the dial. Rotate the ferrite rod on the transmitter in relation to the receiver and find the point that gives maximum volume on your receiver. Morse code can now be transmitted over distances of a few metres or more.

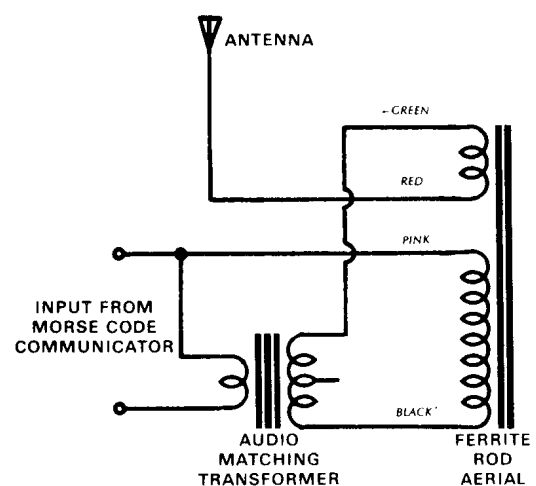

Figure 1

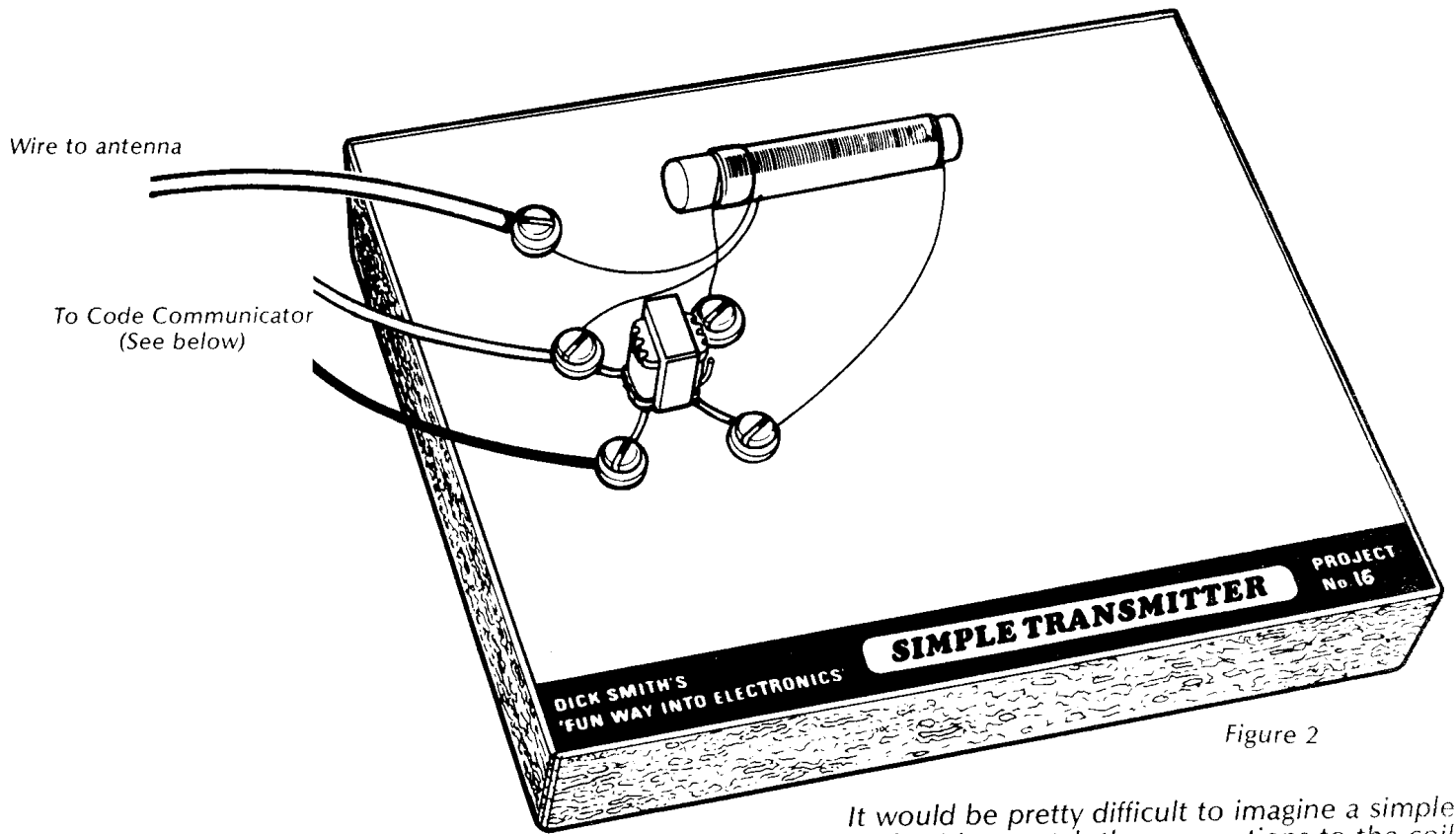

Figure 2

It would be pretty difficult to imagine a simpler project! Just watch the connections to the coil – follow the diagram carefully and you shouldn't have any problems. Note that this project must be teamed up with the Code Communicator (project 9) to operate. Connect as shown in figure 3.

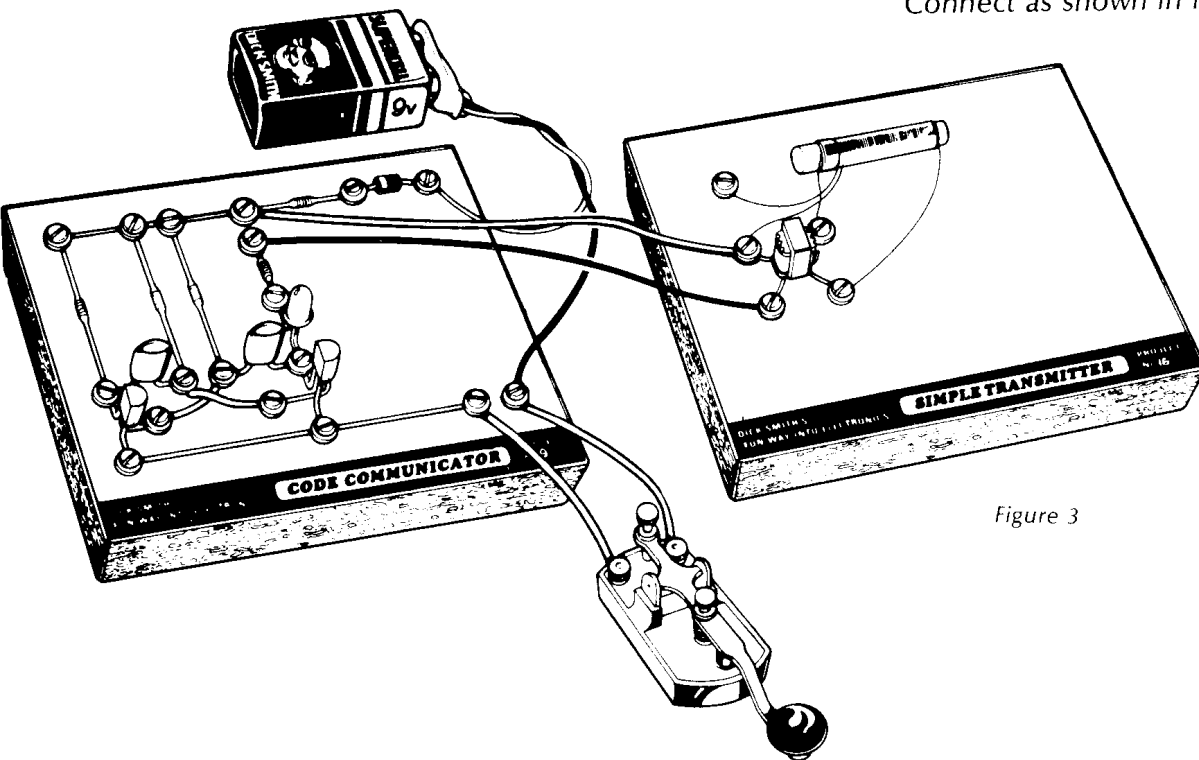

Figure 3

The code communicator creates signals which are fed into the matching transformer of the transmitter. This passes the signals to the ferrite rod antenna which changes the currents into radio waves. These can be tuned on the broadcast band of any radio.

See the last chapter of this book for more details on radio reception and transmission.

Because this transmitter is so simple, you will find varying results with different radio receivers. This is because the sensitivity of the radio receiver determines its range – and because there is so little signal coming from this transmitter, it is seen as a very weak 'station'.

You will note that orientation of the ferrite rod in the transmitter with respect to the receiver has an effect on the range. Try various positions and see what range you can obtain: you can even try connecting a small antenna to the transmitter for better results.

A voice/morse code transmitter



This is a dual project: with it you will be able to transmit messages in Morse code with the aid of the code communicator, or transmit voice with the aid of your two transistor amplifier. Imagine hearing your own voice over the radio!

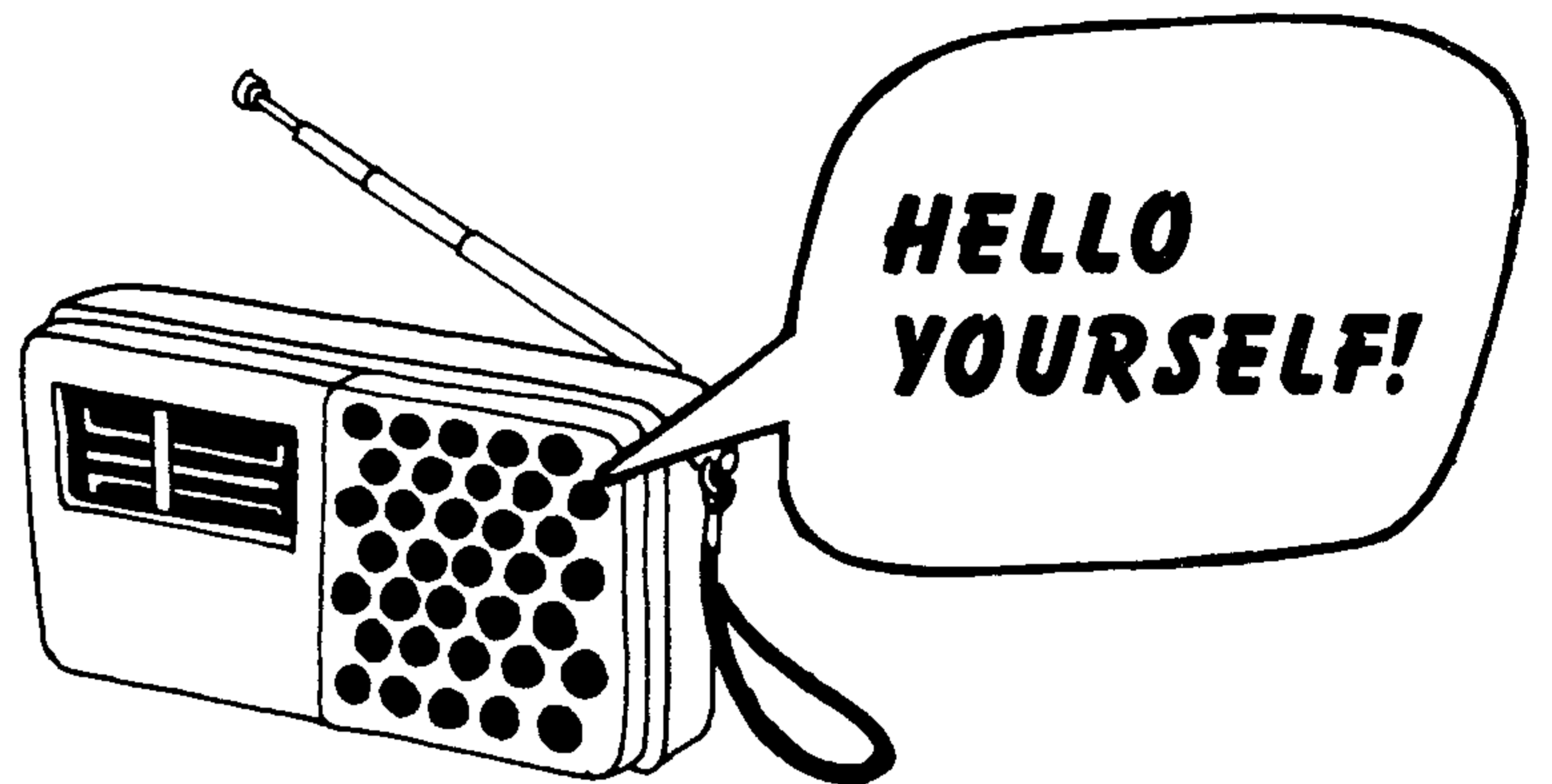

- Resistors:** One 1.2k ohms (brown - red - red)
One 100k ohms (brown - black - yellow)
- Capacitors:** One 0.01uF disc ceramic
Two 0.001uF disc ceramic
One 10uF 16 volt electrolytic type
One 60 to 160pF variable type
- Diode:** One protection diode, 1N4001 or similar
- Transistor:** One NPN type DS548

- Miscellaneous:** One 9 volt battery and clip
One audio transformer, 8 ohm to 1k ohm
One ferrite rod aerial
Two 12cm lengths insulated hook-up wire
One 3cm length insulated hook-up wire
Six lengths tinned copper wire
23 self-tapping screws with washers
Baseboard & project overlay No.17

- (1) No special problems with this project, except that, once again, there are a lot of components to take care of. Use the 3cm length of insulated hook-up wire for the link underneath the diode. Also ensure the wires from the ferrite rod are cleaned of any insulation, and are correctly terminated.
- (2) Connect the battery to the clip.
- (3) Using any broadcast band receiver (normal AM radio stations) find a clear spot near the lower end of the band (closer to 530kHz). Slowly vary the tuning capacitor on the transmitter until you hear the receiver suddenly go quiet – the noise coming from it almost disappears.

This quieting of the receiver is caused by the 'carrier wave' coming from your transmitter. It is on this carrier wave that Morse code and voice communication can be superimposed, as we will shortly explain. Your transmitter is now ready for operation.

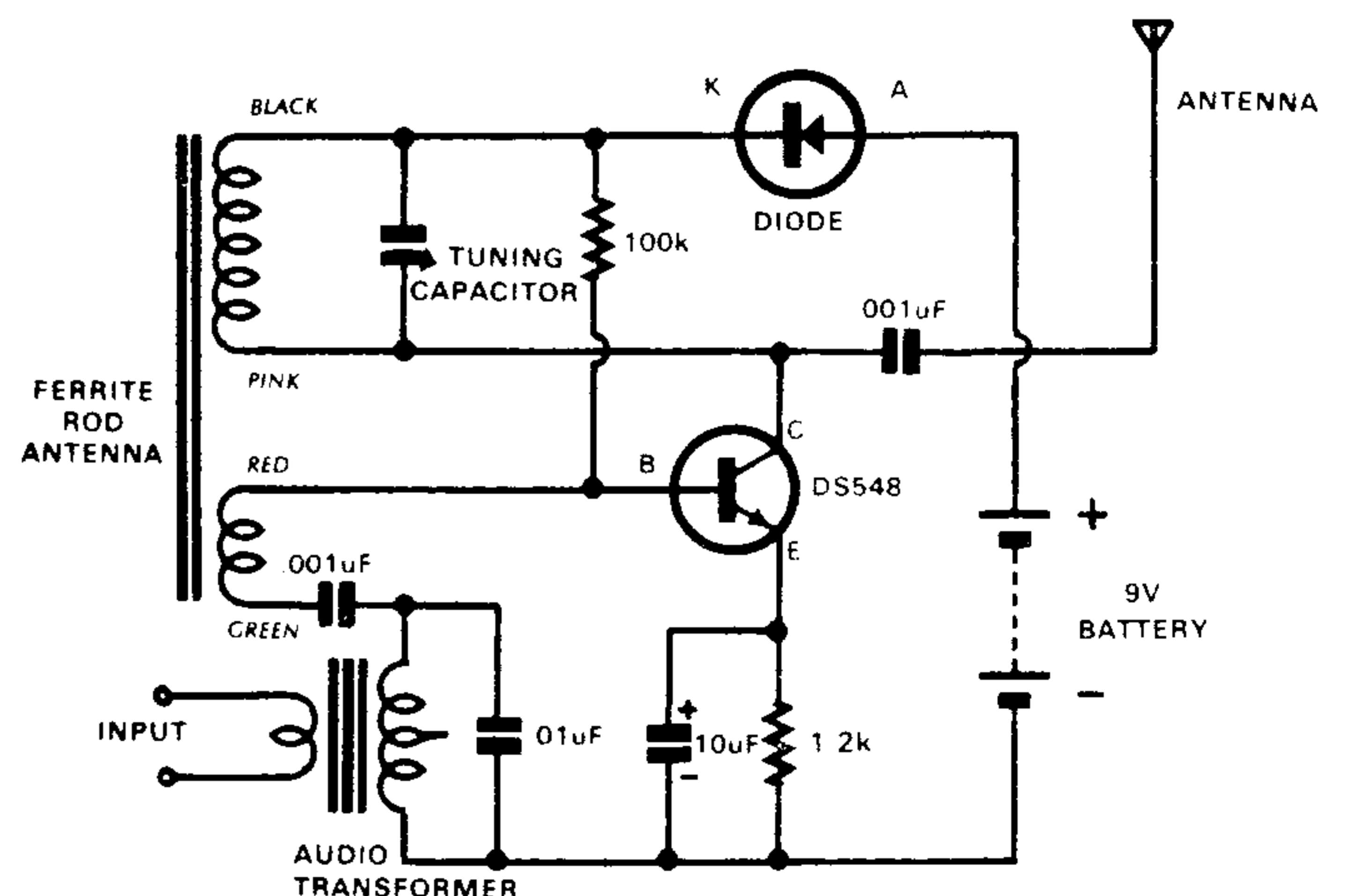

Figure 1

- (1) You will need a built-up code communicator, as described in project 9. Remove the speaker, and replace it with a pair of insulated hook-up leads approximately 10cm long. Connect the other end of these leads to input of the transmitter (the audio matching transformer).
- (2) Connect a battery to each project board and press the Morse key. As long as you have not knocked the tuning capacitor on either the receiver or the transmitter, you should hear the tone coming from the receiver as you press the key. The audio signal from the Morse oscillator is added to the carrier wave of the transmitter, and this is received by the radio receiver.

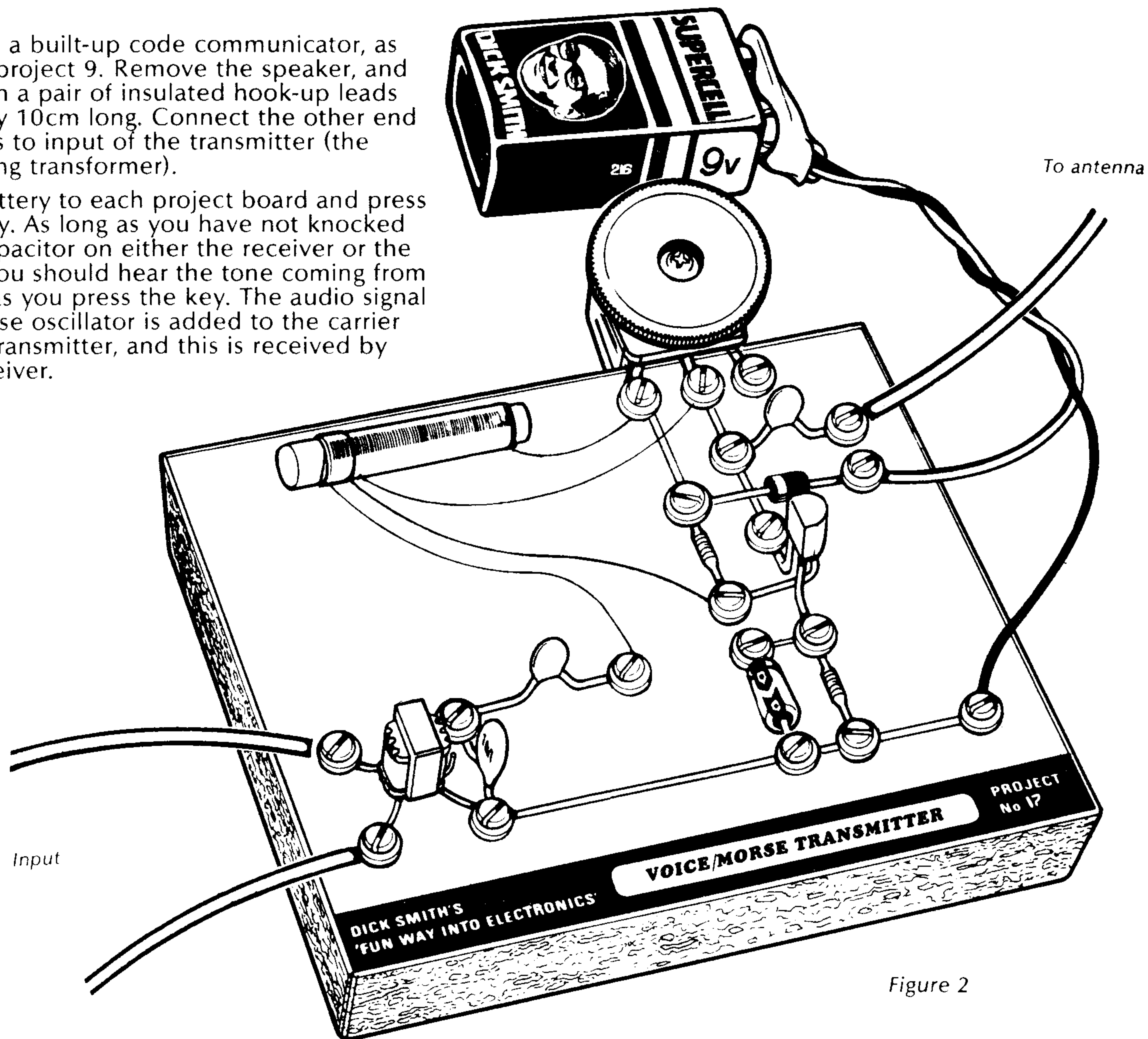

Figure 2

- (1) You will need an audio amplifier: either the two transistor amplifier or the one and two transistor amplifiers connected together as a three transistor amplifier. The output of the amplifier connects to the input of the transmitter.
- (2) You can use a crystal earphone as a microphone, or you can connect a speaker to an audio matching transformer (see the 'components' section) and use that as a microphone for even better results.
- (3) Connect batteries to both the amplifier board(s) and the transmitter board. Speak into the microphone and after tuning the transmitter and/or the receiver to the same frequency, you should hear yourself coming over the radio!

If you add a small antenna to the transmitter board (say a piece of hookup wire approx 1 metre long) you should find the range is increased.

Although the range of these transmitters is limited, it is not a good idea to lengthen the antenna to give increased range. Otherwise you may transmit next door or even further and upset your neighbour's radio reception.

Because of this potential interference, it is illegal to build transmitters which cover any distance unless you hold a radio operator's licence. The simplest form of licence, a Novice amateur operator's licence, is available to anyone regardless of age, upon passing an examination consisting of basic radio and electronics theory, slow Morse code and the regulations pertaining to amateur operators.

For more information on amateur radio, particularly as it applies to Australia, see 'Dick Smith's Australian Amateur Radio Handbook' (details are elsewhere in this book).

A CB radio receiver

Listen in to the exciting world of CB radio: emergency calls, people driving around the cities and others just making friends over the air...

This receiver covers the 'short wave' section of the radio frequencies between 11 and 35MHz. It will also pick up amateur radio operators talking overseas, and world-wide short wave broadcasts, especially during daylight hours.



- Resistors:** One 1.2k ohm (brown - red - red)
One 47k ohm (yellow - violet - orange)
- Capacitors:** One 10pF disc ceramic
One .001uF disc ceramic
One .01uF disc ceramic
One 60 to 160pF variable type
- Diodes:** One protection diode (1N4001 or similar)
One germanium signal diode (OA91 or similar)

- Transistors:** One NPN type DS548
- Miscellaneous:** One 9 volt battery and clip
One 70cm length insulated hook-up wire (for winding coil)
One plastic ball-point pen
Two 6cm lengths insulated hook-up wire
Five lengths tinned copper wire
20 self-tapping screws with washers
Baseboard & project overlay No. 18

- Apart from making your own coil, construction of this project is similar to most others. Watch polarities and cross-overs, as usual.
- The coil is made by winding 18 turns of plastic insulated hook-up wire tightly around a plastic ball-point pen. If you wish, the refill of the pen can be removed first, but this is not necessary. Keep the turns close together and as tight as possible. When it is finished, hold the coil in place with some sticky tape.
- You should leave about 10cm of wire sticking out from each end of the coil, to connect to the circuit. Bare the ends of this wire back about 1cm. Connect the coil to the screws indicated on the overlay, holding it in place with some more tape.
- The CB receiver will work an earphone, but will work better if used with either the one or two transistor amplifier.
- For best reception of CB, you will probably need an antenna designed to receive this band. You can easily make one from two 3 metre lengths of

hookup wire. Suspend one end of one length from a non-metallic object (a piece of string is ideal) and connect the other end to the antenna terminal. Connect the other length to the earth terminal, and, if possible, let it hang vertically down from the receiver board (for example, on your window-sill). This antenna should allow CB reception without being 'swamped' by strong local radio stations.

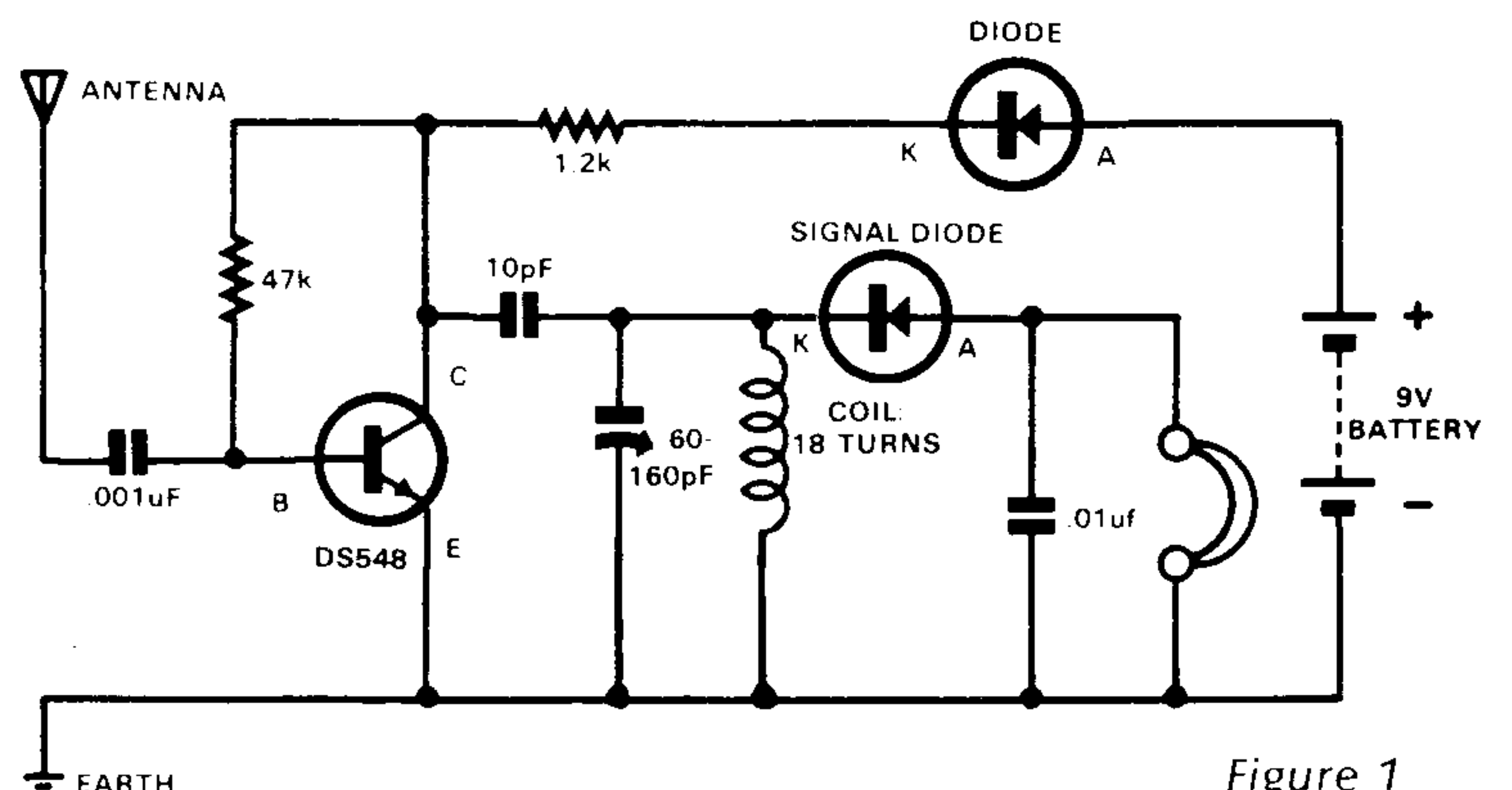

Figure 1

This project has a coil which you actually wind yourself – using an ordinary ball-point pen as a ‘former’. It is not difficult to do, and when you’re finished, you should be able to receive a large variety of stations in the upper short wave bands.

Remember to use plastic insulated wire for the coil: the receiver certainly will not work if you use ordinary copper wire!

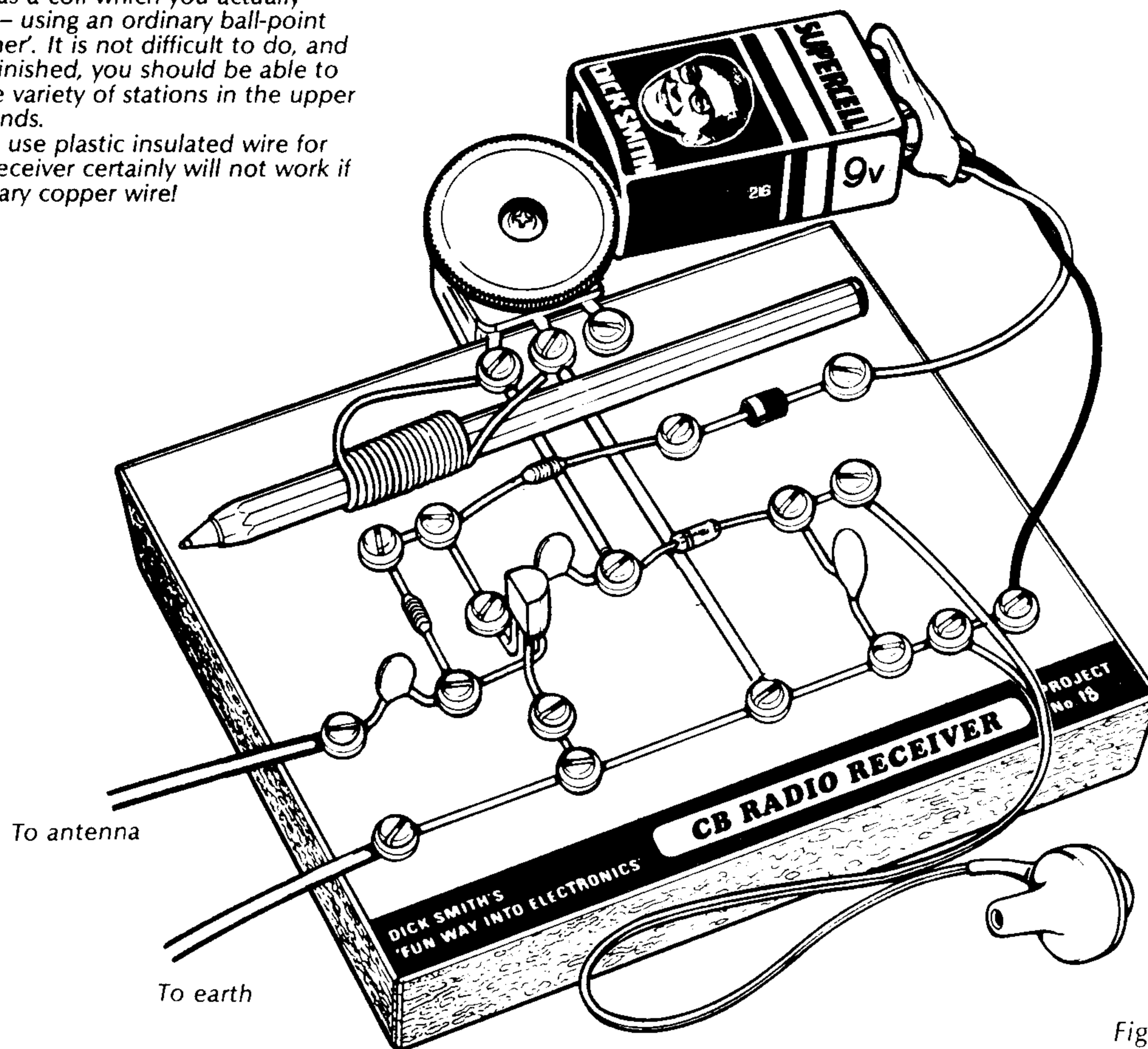

Figure 2

The transistor is used as a radio frequency amplifier to boost the radio frequency currents picked up by the antenna. These amplified currents then pass through a 10pF capacitor into what is virtually a modified ‘crystal set’. See the similarities between this part of the circuit and the crystal set (project 12).

Because of the smaller number of turns on the coil, the frequencies which this radio receives are very, very much higher than the frequencies tuned by the ‘crystal set’ of project 12.

The output of the CB receiver can be heard directly on a crystal earphone, but for best effect connect the one, two (or three) transistor amplifiers.

This receiver will tune from approximately 11MHz to 35MHz, which includes not only the ‘citizens band’ (CB) on 27MHz, but also the 14, 21 and 28MHz amateur bands.

It is possible to tune other frequencies by winding different coils. For example, 80 turns of wire on the ball-point pen will tune a lower frequency – approximately 6 to 11MHz. If you like to experiment, try winding other coils to see what you can receive.

When tuning around the various bands, you may hear sounds that are obviously people speaking, but you cannot tune them – they always sound like ‘Donald Duck’. This is almost certainly a special type of radio transmission known as ‘single side band’ (or SSB). SSB is an extremely effective method of long distance communication – however, special circuitry is required to tune such transmissions to make them intelligible.

An amateur radio receiver

The integrated circuit used in the beer powered radio (Project 14) can also be used to make an amateur band receiver with minor modifications.

It will also receive aircraft, ships and overseas short wave broadcasts, especially during the night. It covers from 2MHz to around 6MHz.

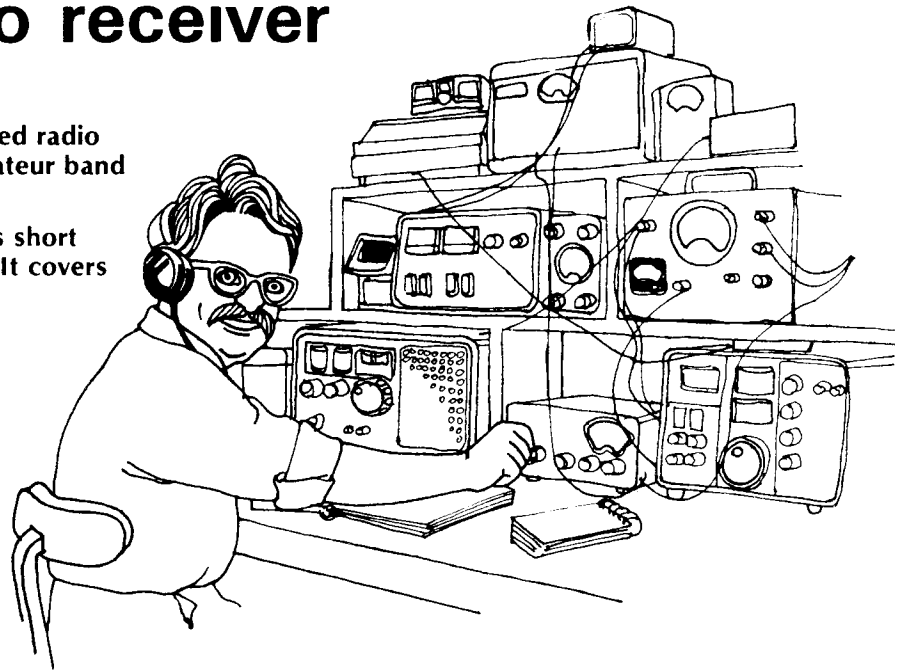

- Resistors:** One 33k ohms (orange - orange - orange)
One 100k ohms (brown - black - yellow)
- Capacitors:** One 0.1uF disc ceramic
One 0.01uF disc ceramic
One 60 to 160pF variable type
- Diodes:** One protection diode, 1N4001 or similar

- Semiconductors:** One ZN414 integrated circuit
- Miscellaneous:** One 9 volt battery and battery clip
One ferrite rod aerial
One crystal earphone
20 self-tapping screws with washers
Baseboard & project overlay No. 19

- (1) Build the 'IC radio' (project 14 modified for 9V operation.) Do not connect the ferrite rod antenna yet – it must first be modified to cover the bands we require.
- (2) Most of the longer winding on the ferrite rod must be removed. This is normally coloured pink, but need not necessarily be so. Carefully scrape away the glue holding the end of the winding in place and unwind the coil until just 7.5mm of the longest coil remains. (See figure 2). When the coil has been reduced to the required width, cut off the excess wire leaving a 10cm length of wire coming from the coil.
- (3) Secure the coil with sticky tape and carefully scrape off a centimetre or so of insulation. Connect the coil to the appropriate terminals of the board, as shown in the layout and overlay.
- (4) With the modified coil the radio should tune approximately 2MHz to 6MHz (2MHz at the anti-clockwise end). A long wire antenna as described for the crystal set will probably work best.

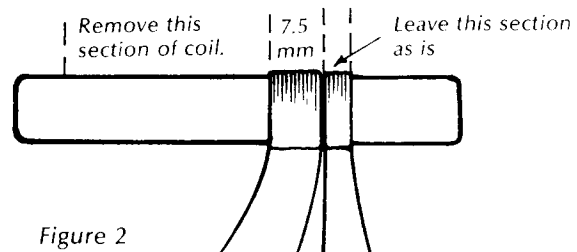
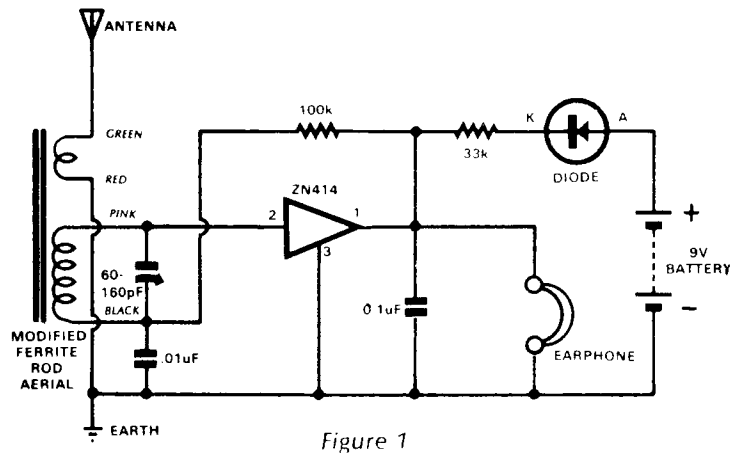

Operation of this type of circuit was explained in project 12. The bandspreading we describe below can be changed to give any range of frequencies within the basic limits of the coil and capacitor, and of the integrated circuit. You can experiment with different values of series and parallel capacitors.

By increasing the value of the capacitor in parallel with the main tuning capacitor, you lower the frequency which occurs with the dial in the anti-clockwise position.

Alternatively, increasing the value of the series capacitor increases the frequency when the dial is in the clockwise position.

This project is virtually a copy of project 14 (modified for battery operation). The only major difference is the ferrite rod antenna – it must be modified to cover the different frequency this receiver tunes. If you wish, you could use the board from project 14 and save construction of another board. Note that one terminal of the tuning capacitor is not used – it is simply screwed to the baseboard for mechanical support.

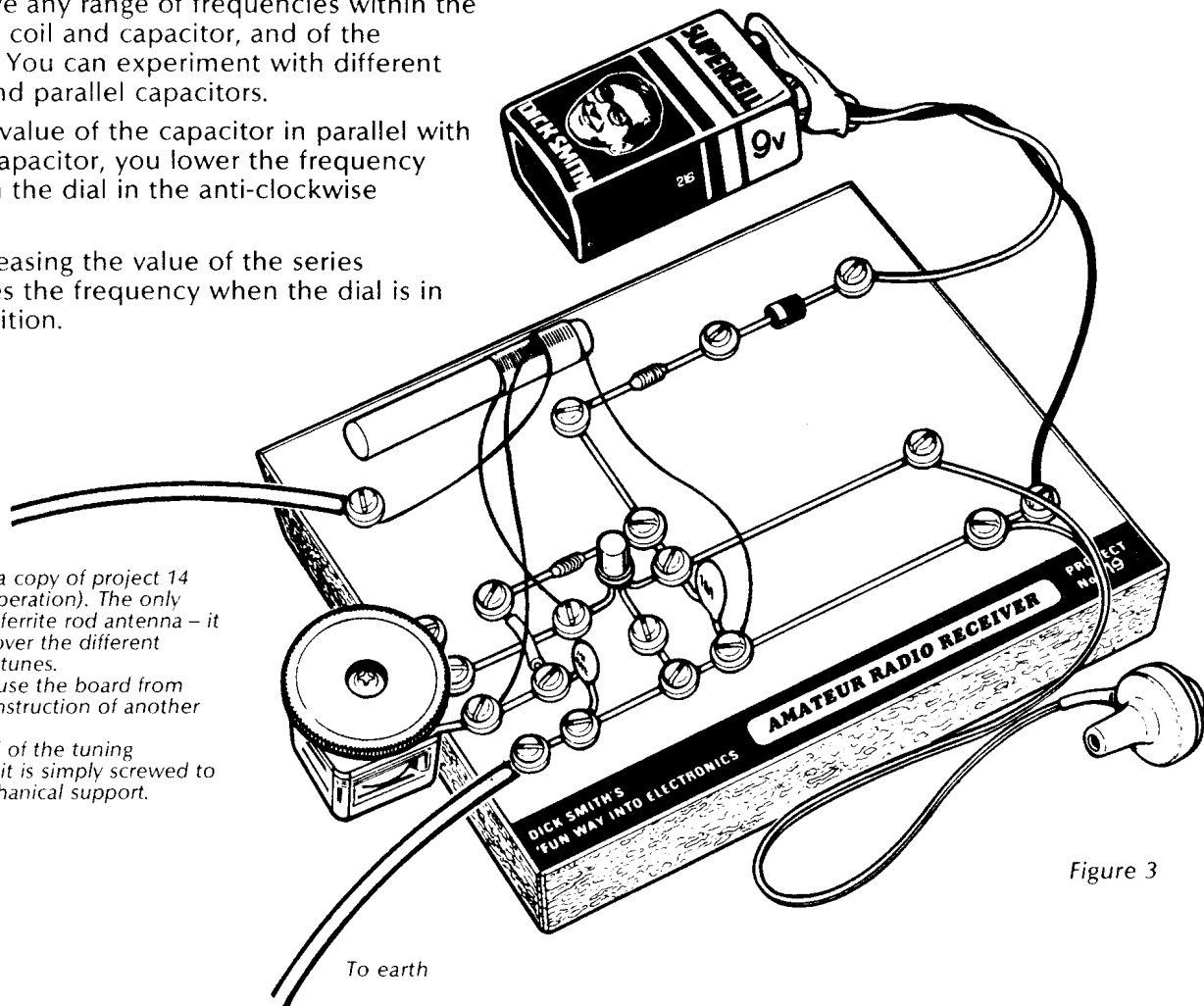

Figure 3

One problem with a receiver of this simplicity is that the stations, particularly on the crowded amateur bands, are very close together. It can be quite difficult to tune them properly. The ability to separate stations is called the receiver's 'selectivity' (as distinct from the 'sensitivity', which is the ability to pick up very weak signals).

We can improve the selectivity by spreading the stations out, either mechanically (by putting in a better tuning mechanism) or electronically. We shall do the latter, making it easier to hear stations on the '80 metre' amateur band – 3.5 to 3.7MHz.

The following modifications will make the variable capacitor tune from approximately 3 to 4MHz. This is called 'bandspreading'.

(1) Add a 47pF disc ceramic capacitor across the two terminals of the variable capacitor which are connected to other parts of the circuit (they may be labelled 'G' and 'A'). this extra capacitor is in parallel with the tuning capacitor.

- (2) Remove the wire link connecting the centre terminal of the variable capacitor to pin 2 of the integrated circuit. Replace it with a 100pF disc ceramic (this capacitor is in series with the others).
- (3) Move the ferrite rod wire from the centre terminal of the variable capacitor onto pin 2 of the integrated circuit.

If you do not wish to modify the set, the original 2–6MHz range of the set can be lowered slightly by placing a ferrite rod aerial beside the one already in the set. There is no need to connect anything or modify the ferrite rod aerial.

This will lower the frequency so you can receive the 1.8 to 1.86MHz amateur band, as well as other stations between the top end of the broadcast band and the above amateur band (some cities have university radio stations in this section).

A radio booster amplifier

A radio frequency amplifier

This amplifier can be added to any of the receivers described in this book to improve reception.

It amplifies the level of radio frequency signals received by the antenna before they are processed by the receiver. In other words, it simply connects between the antenna and the receiver's antenna terminals.

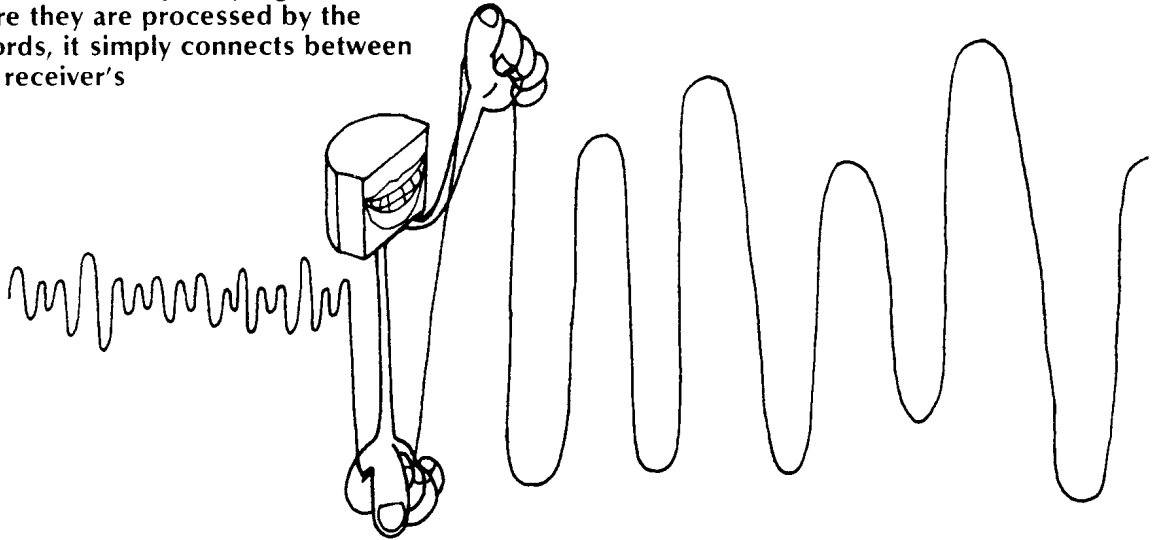

Resistors:	One 1.2k ohms (brown - red - red) One 47k ohms (yellow - violet - orange)
Capacitors:	One 10pF disc ceramic One .001uF disc ceramic
Diodes:	One protection diode, 1N4001 or similar
Transistors:	One NPN type DS548 or similar.

Miscellaneous:	One 9 volt battery and battery clip Two 12cm lengths insulated hook-up wire Four lengths tinned copper wire 13 self-tapping screws with washers Baseboard & project overlay No. 20
-----------------------	--

- (1) This circuit is very similar to the one transistor audio amplifier. The only change is one extra capacitor as well as different values.
- (2) The antenna and earth are removed from the receiver you are going to use, and connected to the 'antenna' and 'earth' terminal of the RF amplifier. The two lengths of insulated hook-up wire connect the amplifier to the antenna and earth terminals of the receiver.
- (3) Connect batteries to both clips. You should find new stations on your receiver, and weak stations now being received at greater strength.

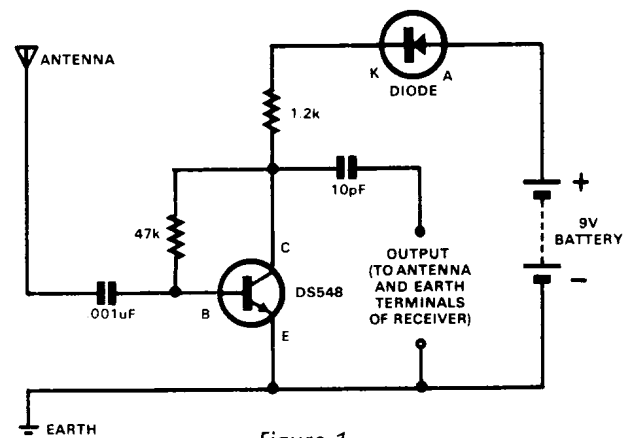

Figure 1

This project is very easy to build, and is not only suitable for the receivers in this book, it can be used with virtually any transistor radio for increased level.

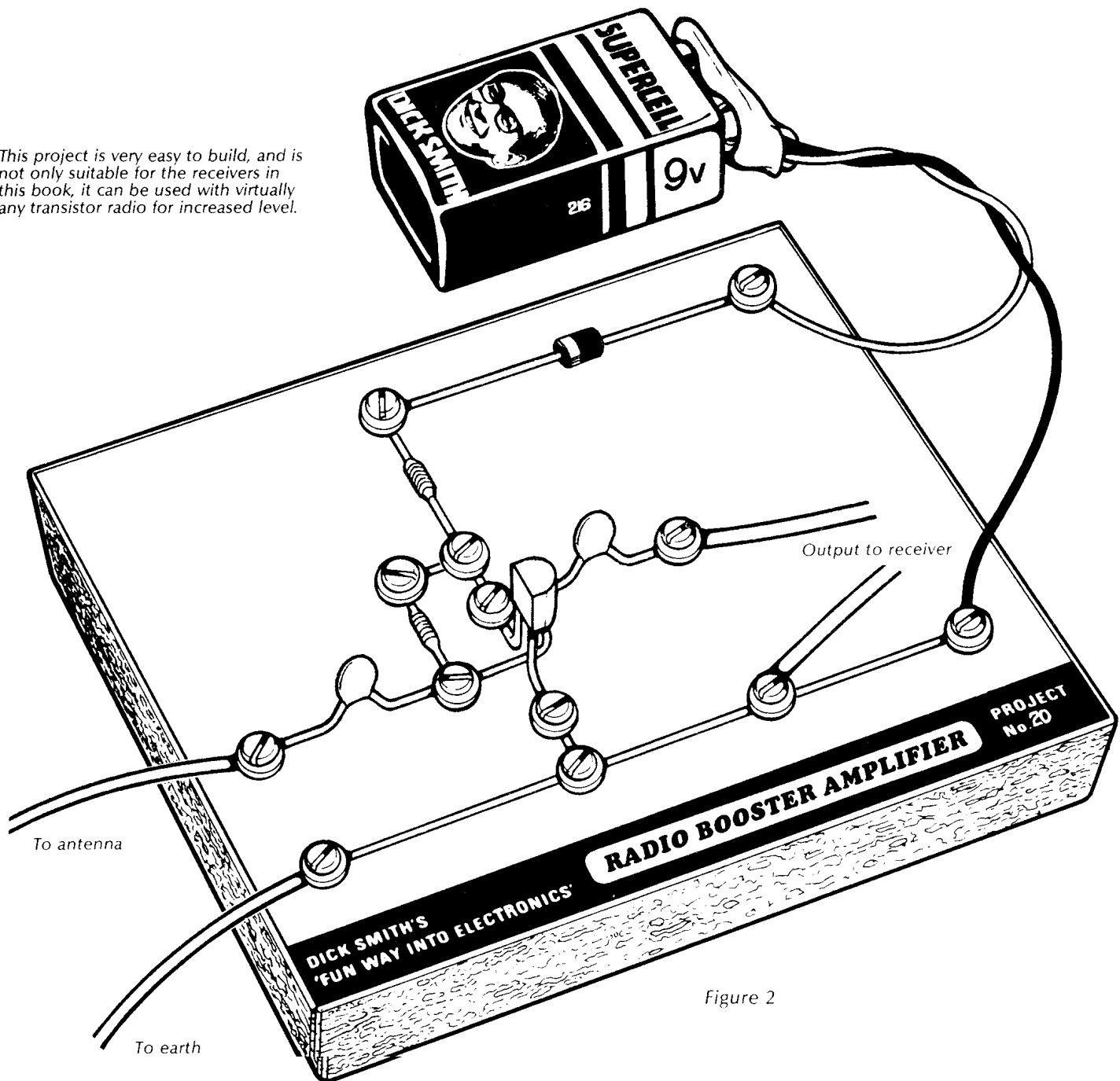

Figure 2

See the section 'all about radio reception and transmission' for background information.

Small radio frequency currents received by the antenna are amplified by the transistor. This amplified current is passed, via the 10pF capacitor, to the antenna terminal of the receiver to be tuned, detected and amplified in the normal way, but at increased strength.

Use the same antenna as you would have used with the receiver. On the beer powered radio, the CB and amateur receivers, it is possible that the RF amplifier provides too much signal. Stations may become distorted, or they may not be tuneable (that is, they appear in more than one spot on the tuning dial – perhaps over most of it).

If this happens, the RF amplifier is 'overloading' the receiver and the signal level must be reduced. Try disconnecting either the earth connection to the amplifier itself, or the earth connection between the amplifier and receiver. Or reduce the length of your antenna, say to about 5 metres long.

To many people, radio remains one of the mysteries of the twentieth century. Somehow, the record playing in a studio somewhere is heard on a radio in the home. Between the two – who knows?

Radio really isn't all that mysterious: if you can grasp a few basic principles, you're well on the way to understanding it!

You may have heard the expressions 'DC' and 'AC'. Perhaps you even know what they mean: direct current and alternating current. But do you know what these mean?

When we connect a battery to a circuit, current flows. But it flows in one basic direction only: by convention, from the positive terminal, through the circuit and back to the negative terminal.

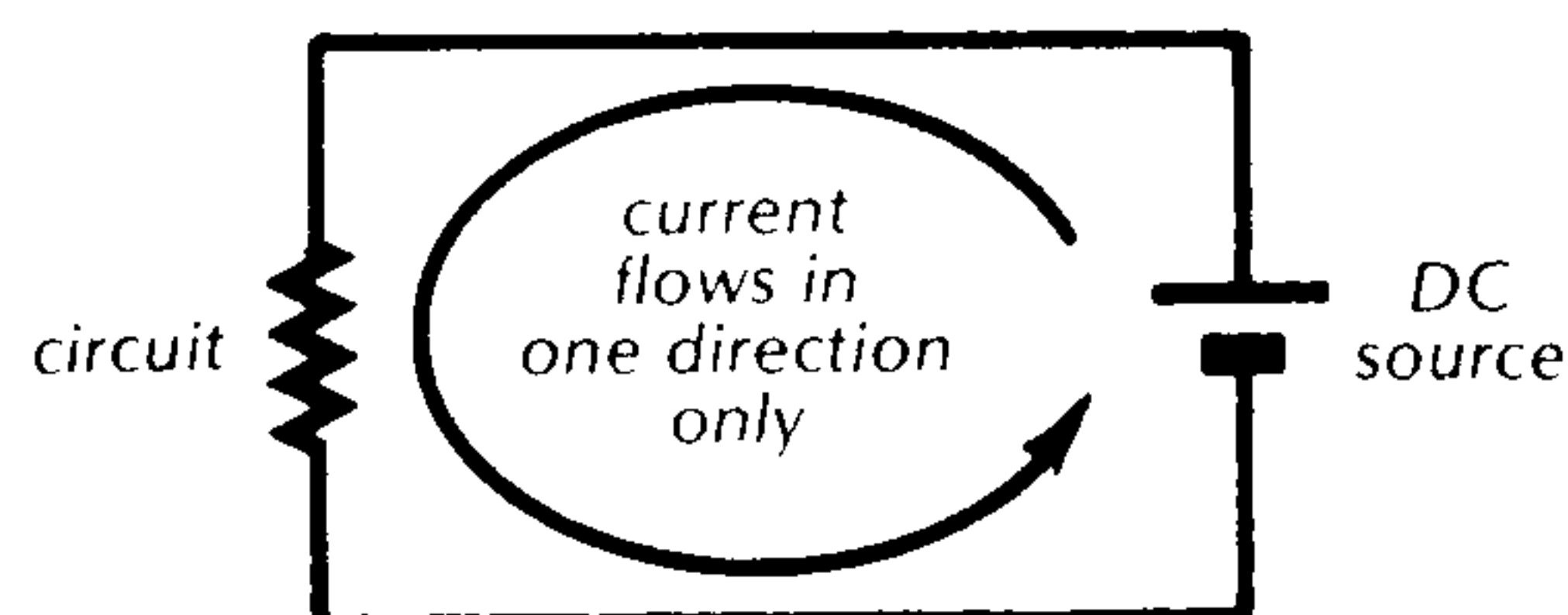

Figure 1

But current doesn't have to flow in one direction only. For example, when you turn on a light in your home, the current that causes that lamp to glow is actually changing direction – one hundred times every second! This is called alternating current: periodically, the current reverses direction of flow or **alternates**.

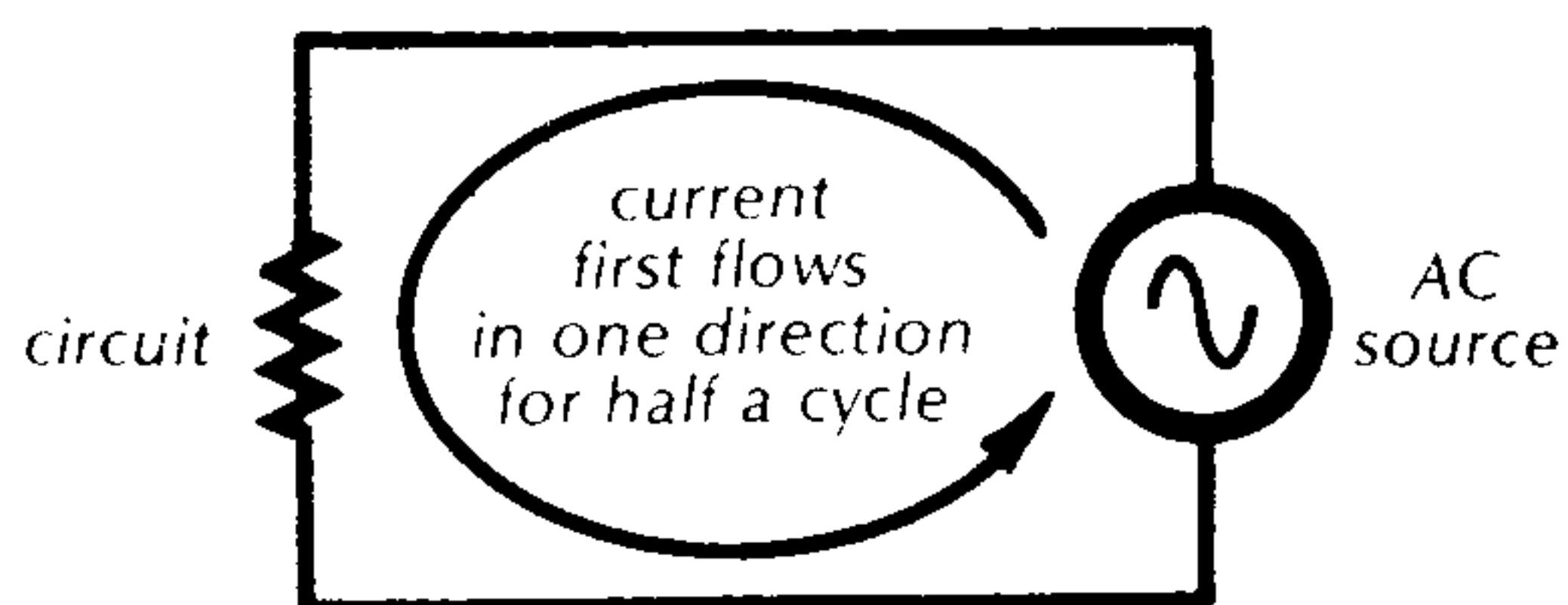

Figure 2

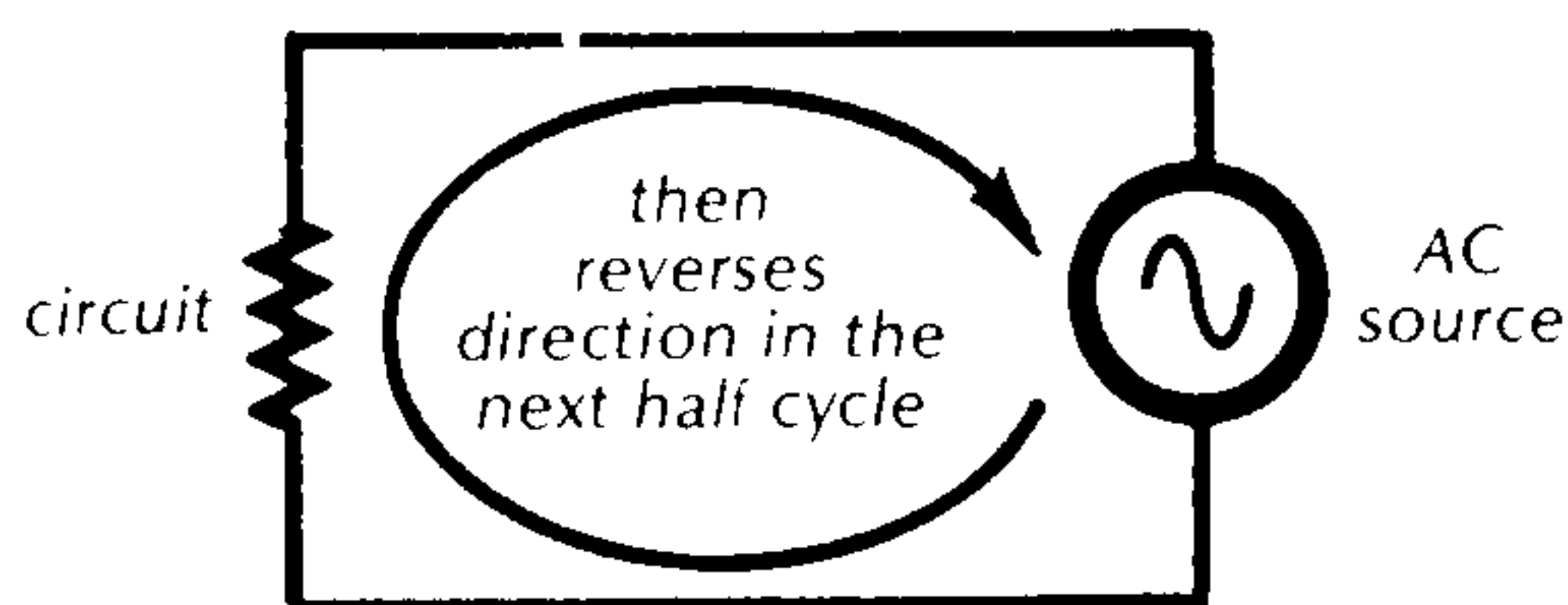

Figure 3

If you were able to measure the current, you would find that it follows a fixed routine. It would start off at zero, rise to a maximum, fall back to zero, then reverse direction, rising to a maximum, falling back to zero and reversing direction again. It would look something like the graph shown in figure 4. The 'cycle' would repeat over, and over again. If you counted the number of full cycles, ie each time the current started flowing in the same direction again, you would know the **frequency**. Frequency is the number of cycles per second.

Current may range in frequency from just a few cycles per second – or **hertz (Hz)** to many, many millions of hertz.

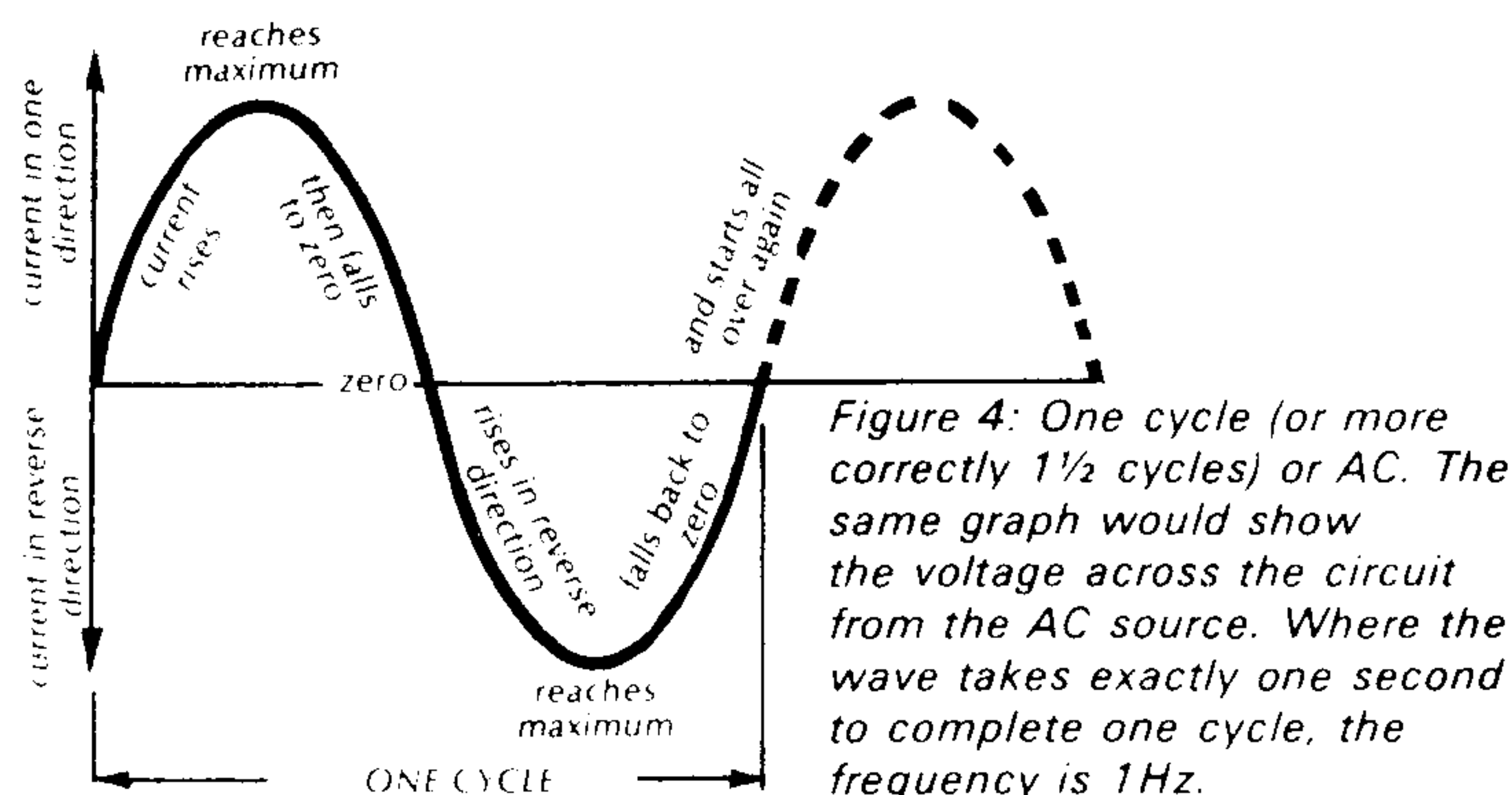

Figure 4: One cycle (or more correctly 1½ cycles) of AC. The same graph would show the voltage across the circuit from the AC source. Where the wave takes exactly one second to complete one cycle, the frequency is 1Hz.

Turning our attention away from AC & DC and frequency for a moment, let's go back to one of the components we used in our projects – the capacitor. Remember capacitors store electric charges. We can use this charge by making the capacitor cause a current to flow in the circuit – losing its charge as it does. There is one thing about a capacitor which we didn't mention before, however. Not all the charge stored in a capacitor can be used. As we release the charge, some of it 'escapes' – not into the circuit, as current, but out of the capacitor altogether.

You might think that this is a waste of energy. Indeed, in some cases it is. But it is also the basis for all radio communication, for this energy which escapes from a capacitor (or, for that matter, from an inductor – but let's not complicate the issue!) is a form of energy called **electromagnetic radiation**, which can pass through air, through the near vacuum of space, through solid bricks and mortar . . . It is what we commonly refer to as a radio wave.

If a capacitor is connected across a source of DC, the electromagnetic radiation, or **field** occurs just once, as the capacitor discharges.

However, if the capacitor is connected across an AC source, this radiating field occurs each and every time the direction of current changes. And obviously, the electro-magnetic field occurs with the same frequency as the AC supply which causes it. If the capacitor happens to be in a circuit using voice frequencies (commonly called **audio frequencies**), the energy radiated is a reproduction of the audio frequency!

You might imagine, then, that it would be possible to set up a communication system using this effect – to be picked up by an earphone the other end. Possible, yes. Practical: no!

For a communication system of this type massive radiating and receiving aerials are needed – some many kilometres long – to radiate sufficient signal to be of

any use. And this calls for enormous amounts of power. Just as great are the problems at the receiving end!

It just so happens, however, that as we increase the frequency, electromagnetic waves become easier and easier to radiate. So much so that by the time the frequency has reached a few hundred thousand cycles per second (hertz) we can radiate modest amounts of power, using manageable aerial systems, whose waves

can travel over vast distances. Receiving them is not too difficult, either.

We call frequencies above the range of hearing **radio frequencies**: from around 20,000Hz to many, many millions of Hz. Above radio frequencies are heat waves, infra-red and visible light, ultra violet light, x-rays, gamma rays, etc etc. Yes, all these forms of radiation are electro-magnetic in nature.

A basic radio transmitter consists of a source of RF current (called an RF oscillator), an amplifier capable of handling the high frequencies involved, and an aerial. This is the basis of a Morse Code transmitter: the Morse key simply switches the RF oscillator on and off.

To transmit speech or music is slightly more difficult. If we look at an ordinary transmitter, such as you would find in a broadcast station, the RF oscillator keeps going all the time, putting out a signal called a **carrier**.

Audio frequencies (which may come from a microphone, record player, tape recorder, etc) are first amplified, and then fed into a **modulator**. This is a circuit which changes the level or strength of the carrier wave in direct proportion to the audio signal being fed into it. So the carrier wave is still the same frequency as it was when it left the oscillator; it just varies in level, or **amplitude** from moment to moment.

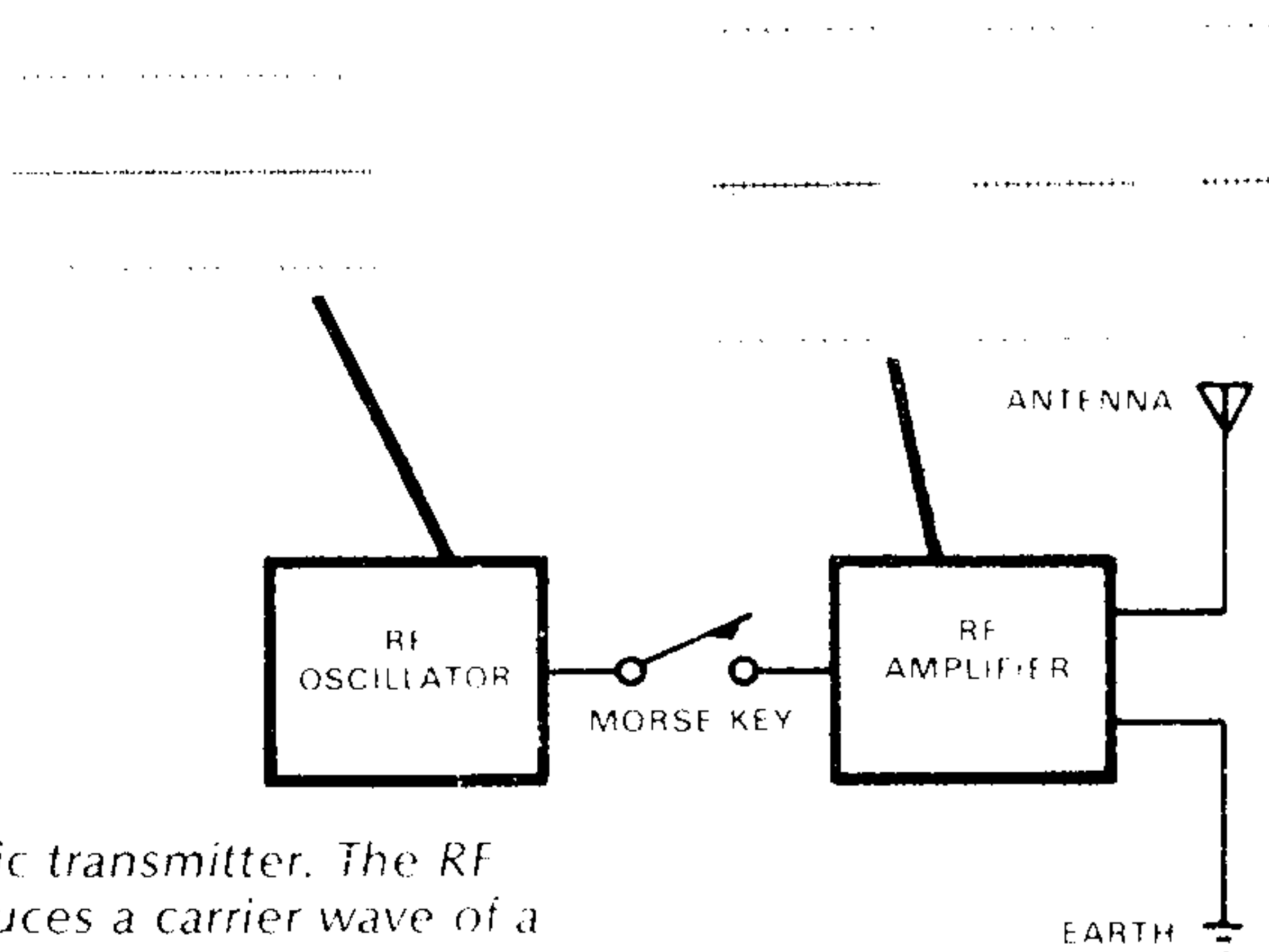

Figure 5: A basic transmitter. The RF oscillator produces a carrier wave of a specific frequency. The key interrupts this to produce a keyed carrier wave, before the signal is amplified and fed to the antenna for transmitting.

The end result is an **amplitude modulated** radio frequency current which is fed into the aerial. In fact, the aerial you see is only half the story – the other half is buried in the ground underneath. The two halves form a giant capacitor – and you know what happens when RF waves are fed into a capacitor.

Electromagnetic radiation – radio waves – travel outwards from the aerial just as do ripples on a pond into which you've just thrown a pebble.

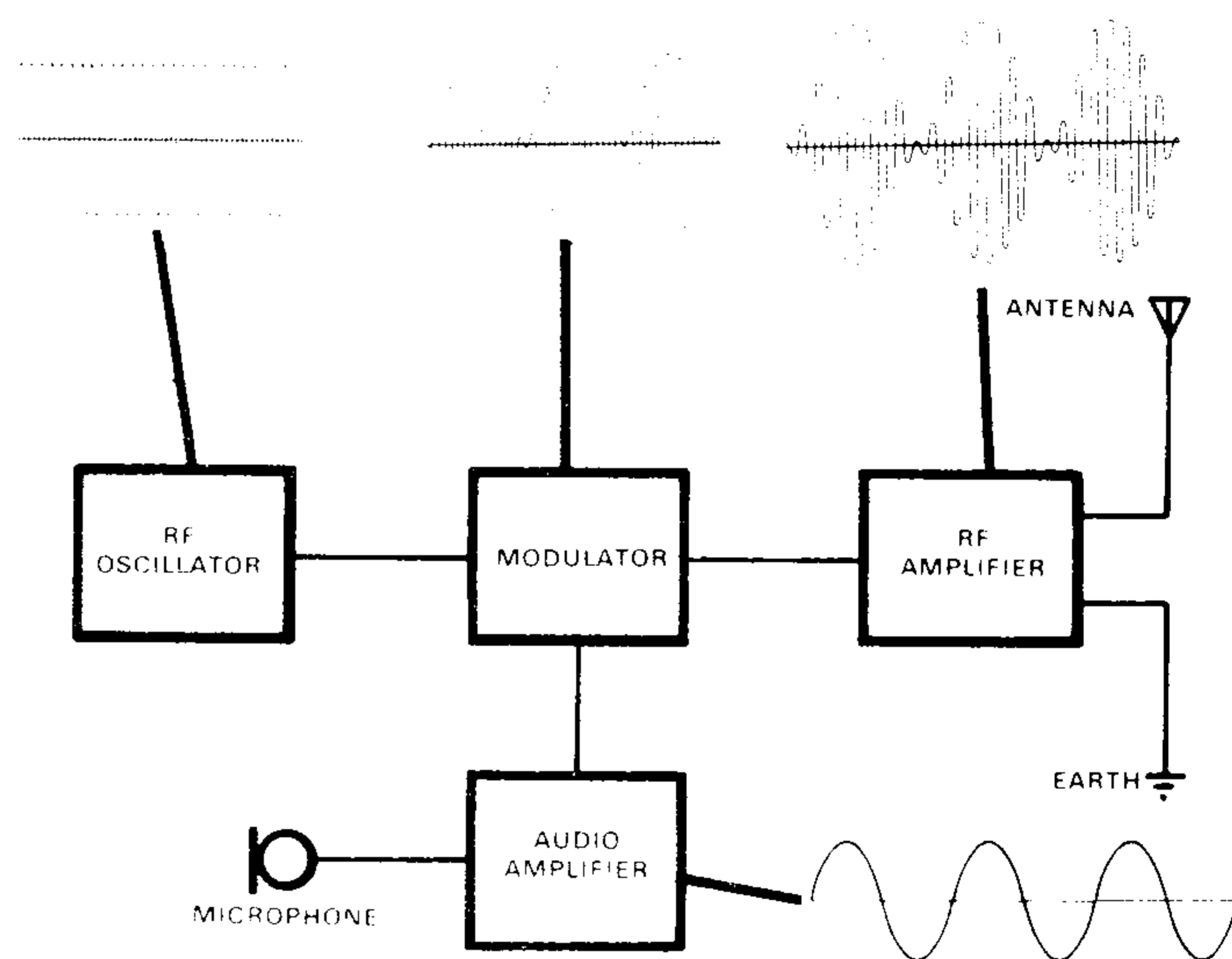
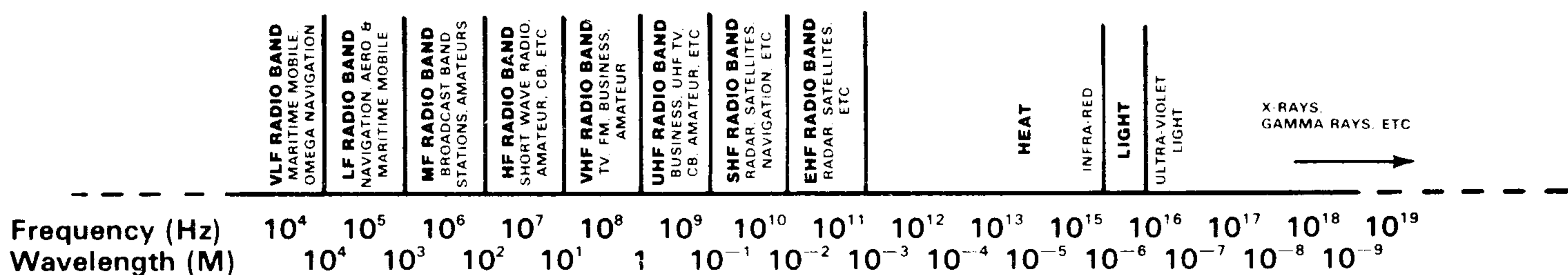

Figure 6: An amplitude-modulated transmitter. The vital part of this transmitter is the modulator which allows any audio signal information to be transmitted along with the carrier wave. While we have shown a microphone, any source of audio frequency signals works the same way.

the electromagnetic spectrum



This shows the relationship between the various radio bands and the other types of electromagnetic energy. The abbreviations of the radio bands give a clue to their frequency (very low, low, medium, high, very high, ultra high, super high and extreme high). Heat, light, x rays & gamma rays, etc, have very much higher frequencies. Sound is not shown on this graph, because sound is not electromagnetic energy. Sound waves cannot pass through a vacuum, and travel much, much slower than electromagnetic waves.

A radio receiver, in its simplest form, is virtually the opposite of a transmitter. The aerial (which may be disguised as a ferrite rod aerial in a small portable); a de-modulator and a means of recovering the audio signal. Let's start with the aerial.

The receiving aerial is, once again, half of a capacitor. And, just as a capacitor radiates an electromagnetic field if an alternating current appears across it, so an alternating current is made to flow if an electromagnetic field appears between the two sides of a capacitor.

The amount of current is very, very small – often only after a great deal of amplifying is it of any real use. That is why broadcast band aerials are best as high, and as long as you can make them; the larger the aerial, the more signal you are likely to receive.

The aerial receives, for all practical purposes, all the electromagnetic radiation it intersects. Each radio wave causes a different frequency current to be caused to flow. It is up to the receiver to filter out the particular one we want!

The tuning circuit does this job for us. This is, in effect a very good filter which discards all the various RF currents bar one: the one which we have selected by the setting of the tuning capacitor.

The RF signal, still amplitude modulated, then passes to the diode detector. As we explained in our projects, diodes let current pass in one direction only. What is left is half of the original waveform – the bottom half being blocked by the diode.

Why block half? An earphone or loudspeaker would see the two-sided waveform as a mirror-image. It would simply add the positive half of the wave to the negative half of the wave and we would end up with: nothing!

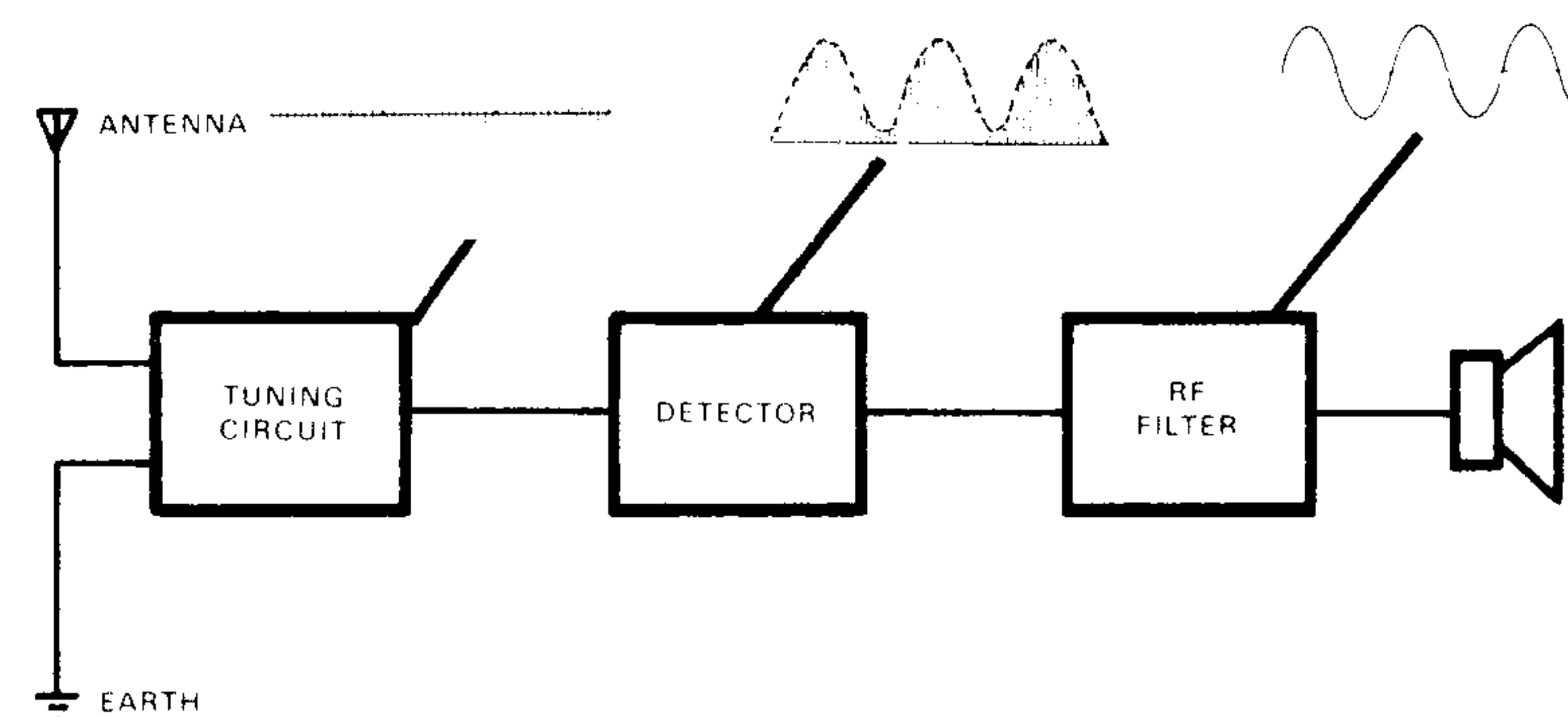

The half-cycle waveform still carries the audio signal information, but we are finished with the RF section. It has done its job in transferring the audio from the transmitter to the receiver, so now we can discard it. We normally use a capacitor which is small enough to respond to the audio signal, but is too large to charge quickly enough to be able to respond to the RF carrier. So it acts as if it simply ignores the RF – leaving the audio waveform. (In actual fact, this capacitor can often be left out of crystal sets, because the earphone itself cannot respond fast enough to RF, and it too ignores it and works only on the audio signal).

All that remains now is for the AF signal to be fed into an earphone, or to be amplified in order to drive a speaker for us to listen to.

Our description has, by necessity, been brief. For we have barely skimmed the surface; hopefully the explanation will enable you to understand radio a little better. Obviously, there are many other ways to achieve the various functions of a receiver: we have really talked only about the basic 'crystal set'. Most receivers, for example, reduce the original received frequency to a lower frequency to make it more manageable before detection.

If you want to know more about radio, there are a lot of good books to which you can refer. Among these are the publications put out by the American Radio Relay League (such as 'The Amateur Radio Handbook' or 'A Course in Radio Fundamentals'.) Or you could try Dick Smith's Australian Amateur Radio Handbook – or read the excellent introductory articles published from time to time by the electronics magazines such as 'Electronics Australia' or 'Electronics Today International'.

Figure 7: The basic steps in the de-modulation (or detection) of an amplitude-modulated radio transmission. The antenna system receives transmissions from all radio stations within range – it is up to the tuning circuit to filter out just one. This is then detected by a signal which allows only half of the signal to pass. The dotted line drawn on the signal shown after the detector represents the original audio information we are trying to recover. After passing through an RF filter, all that is left is this audio information. We have shown this feeding to a speaker for clarity only; obviously if a speaker is used there must be an audio amplifier between the it and the RF filter.

Aerial (antenna)	These terms are often used to mean the same thing. For our purposes, a length of wire strung high in the air for the purpose of receiving radio waves.	Current	A movement of electrons along a wire or other conductor. By convention, current flows from the positive terminal, through the circuit and back to the negative terminal of the battery.
AC	Stands for alternating current. Current which goes through a number of 'cycles' of reversal each second.	Dark State	When referring to a light sensitive device such as a LDR, the dark state refers to the specifications or operating conditions when no light is falling on it. (Converse: light state).
AM	Stands for Amplitude Modulation. One of the types of radio communication (the type used by broadcast stations) where audio frequency signals vary the strength of a radio frequency 'carrier wave'. This is called 'modulation'. See the section on 'radio'.	DC	Stands for direct current – current which does not change in direction.
Amplify	To enlarge. An amplifying circuit takes very small electric current and produces an enlarged version, yet retains the original signal information.	Earth (Ground)	Normally taken to mean the same thing. Can mean a direct connection to the earth itself, but is also used to mean a connection to a chassis or point of zero voltage.
Audio Transformer	A device which transfers signals from one section of a circuit to another. See 'components' section.	Earphone	A device for turning electrical energy into sound waves. See 'components' section.
Base	One of the connecting leads of a transistor. See 'components' section.	Electric Current	See 'current'
Battery	A device for supplying power. See 'components' section.	Electrolytic	When used in conjunction with capacitors, refers to the type of capacitors made with an 'electrolyte' (See 'components section'). Electrolytes are chemical liquids or pastes having certain properties, used in various ways in electronics.
Broadcast Band	The section of the radio frequency spectrum covering 'local' radio stations – normally 530 to 1600kHz.	Emitter	Another lead of a transistor. See 'components' section.
Capacitance	Having the properties of a capacitor. See 'components' section.	Feedback	Occurs when some or all of the output of a device (an amplifier, for example) can be fed back into the input. Feedback may be accidental and unwanted (as in the case of acoustic feedback from a speaker to a microphone with a resultant squeal) or deliberate (as in many types of circuits where feedback assists in correct operation).
Carrier Wave	In an 'AM' radio wave, that section which does not have any signal information of its own, but carries the signal along with it.	Ferrite Rod Aerial	A coil or coils of wire wound around a rod made of ferrite (a black or dark grey material). Ferrite concentrates the effects of the coil
Cell	A single battery or chemical power source. The batteries we use in these projects contain 6 cells.	Frequency	The number of times an AC signal repeats its cycle each second. It is measured in Hertz (Hz). Was formerly called cycles per second.
Circuit	The components, connections, wires and hardware that together form a working module. A drawing of the circuit is called a circuit diagram or schematic diagram.	Generator	A device for mechanically or electronically producing electric current. Normally refers to a machine producing DC – but can also be used in other contexts.
Collector	Another of the leads of a transistor. See 'components' section.	Germanium	A rare mineral, from which germanium small signal diodes are made.
Conductor	An object which will allow electricity to flow through it. Most metals are conductors, most non-metals are not. Some conductors are better than others.	Greencap	A colloquial name given to a type of polyester capacitor. See 'components' section.
Connection	Where two (or more) component leads or hookup wires actually and deliberately touch, so that current can flow between them. If a connection occurs where it is not wanted it is sometimes called a 'short circuit' (or short).	Hertz	See frequency.
Crossover	Where two component leads or hookup wires intersect, but no connection occurs because they are insulated from one another.		

Input	The side of the circuit to which a signal is fed for processing. (Converse: output).	Power	Normally taken to mean the source of energy which makes a circuit work (e.g. when power is applied).
Insulator	An object which will not allow electricity to flow through it. (Converse: conductor). Some wires are covered with a plastic insulator to prevent them shorting to other conductors.	Primary	(a) the 'input' side of a transformer. (b) a non-rechargeable battery, such as a torch battery.
Integrated Circuit	A tiny piece of semiconductor material containing up to thousands of transistors, diodes, resistors, and other components.	Probe	Usually connected to test equipment to enable connection to various parts of the circuit under test.
Leaking	(a) electrolyte escaping from a battery, capacitor, etc. Often very corrosive. (b) the action whereby a charge stored in a capacitor or battery slowly diminishes. Occurs because no components can be made 100% perfect.	Radio Frequency	The part of the spectrum with frequencies from around 20kHz and above.
LED	Short for Light Emitting Diode. See 'components' section.	Schematic	Another name for circuit diagram.
LDR	Short for Light Dependent Resistor. See 'components' section.	Secondary	(a) The 'output' side of a transformer. (b) A re-chargeable battery, such as a car battery. You can feed electric current back into the battery and charge it. You must not do this with a torch battery.
Loudspeaker	Another device for converting electric currents into sound waves. See 'components' section.	Semiconductor	(a) Neither a conductor nor an insulator, but somewhere in between. Often with the properties of being able to change by various means. (b) The name given to a whole family of devices using semiconductors for their operation: transistors, diodes, integrated circuits, etc.
Matching Transformer	See audio transformer.	'Small Signal'	A device which is not meant to handle large currents. Such devices are easily damaged if overloaded.
Microphone	A device for converting sound waves into electric currents. See 'components' section.	Spaghetti	A form of insulation. See 'components' section.
Modulated	See AM.	Switch	A device for connecting and disconnecting power or other components to a circuit or parts of a circuit.
Monitor	To continually examine. We use LEDs to continually examine parts of the circuits – they glow if current flows.	Time Constant	In our circuits, a measure of the time it takes for a capacitor to charge (or discharge), with a certain resistor.
Morse Code	A system of communication invented by Dr. Samuel Morse many years ago. It relies on the sending of only two sounds – a short one and a long one. All letters and numerals are represented by combinations of these sounds.	Tolerance	All components are made so they are within a certain percentage of their marked value – this is the tolerance. For example, a resistor marked 1k, 5% might in fact have a value anywhere from 950 ohms to 1050 ohms.
Multivibrator	A popular circuit in electronics where two transistors are made to alternately turn on and off.	Transistor	A semiconductor amplifying or switching device. See 'components' section.
NPN	One of the types of transistor we use in this book (converse, PNP). See components section.	Transmitter	A device for emitting radio waves. These may be bursts of carrier wave (such as a Morse transmitter) or they may be modulated by audio frequencies (as in a voice transmitter).
Oscillator	A circuit which produces alternating current. Can be at any frequency, but normally used in relation to audio or radio frequencies.	Tuning Dial	A dial connected to a variable capacitor, often marked so the stations can be easily found. See 'components' section.
Output	That part of the circuit where the processed signal is available for use. (Converse: input)	Variable Capacitor	A type of capacitor constructed so that it can be varied by moving a rotating shaft. Usually used with some form of tuning dial. See 'components' section.
PNP	Another type of transistor we use. (Converse NPN). See components section.	Volume	The level of sound which comes from a loudspeaker or earphone. A volume control is usually a potentiometer, and is situated at the input to the main amplifying section of the circuit.
Polarised	A component, plug, etc, which must be inserted or connected a certain way for the circuit to operate. If reverse connected, damage may occur.		
Polarity	The specific way a polarised component must be connected to the circuit for correct operation (see 'Polarised' above).		
Polyester	A type of capacitor. See 'components' section.		

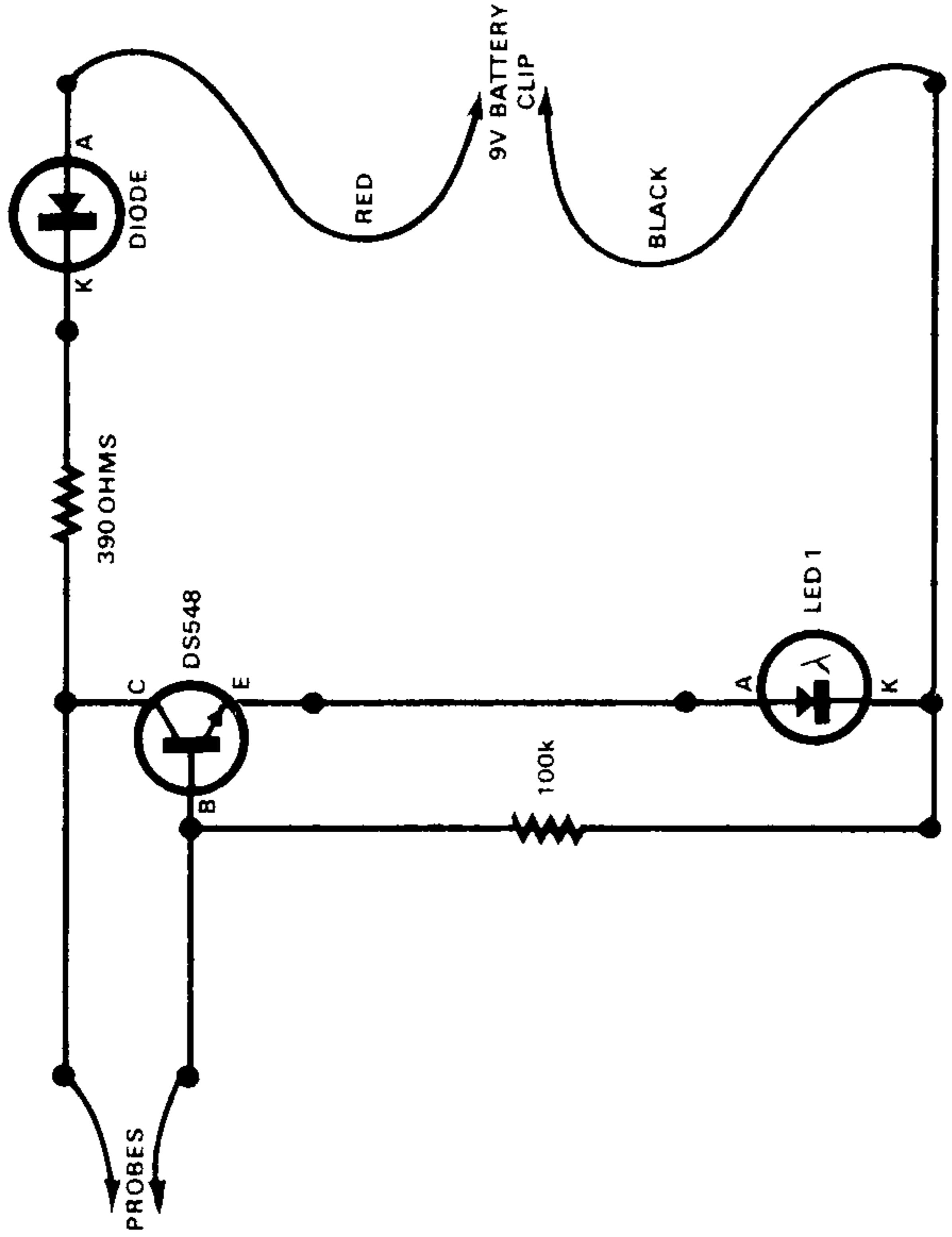

DICK SMITH'S
'FUN WAY INTO ELECTRONICS'
WATER INDICATOR
PROJECT
No. 3

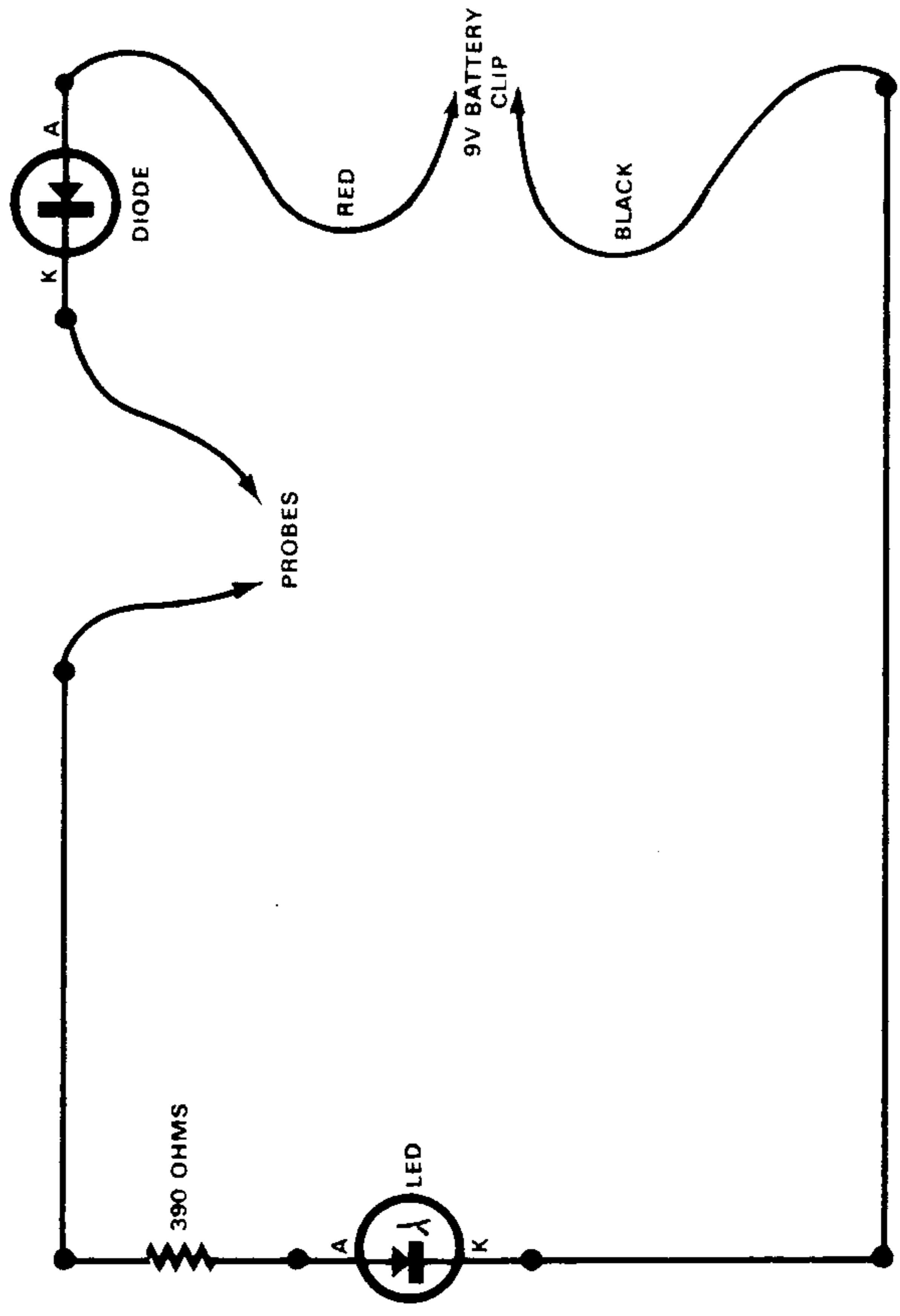

DICK SMITH'S
'FUN WAY INTO ELECTRONICS'
CONTINUITY INDICATOR
PROJECT
No. 1

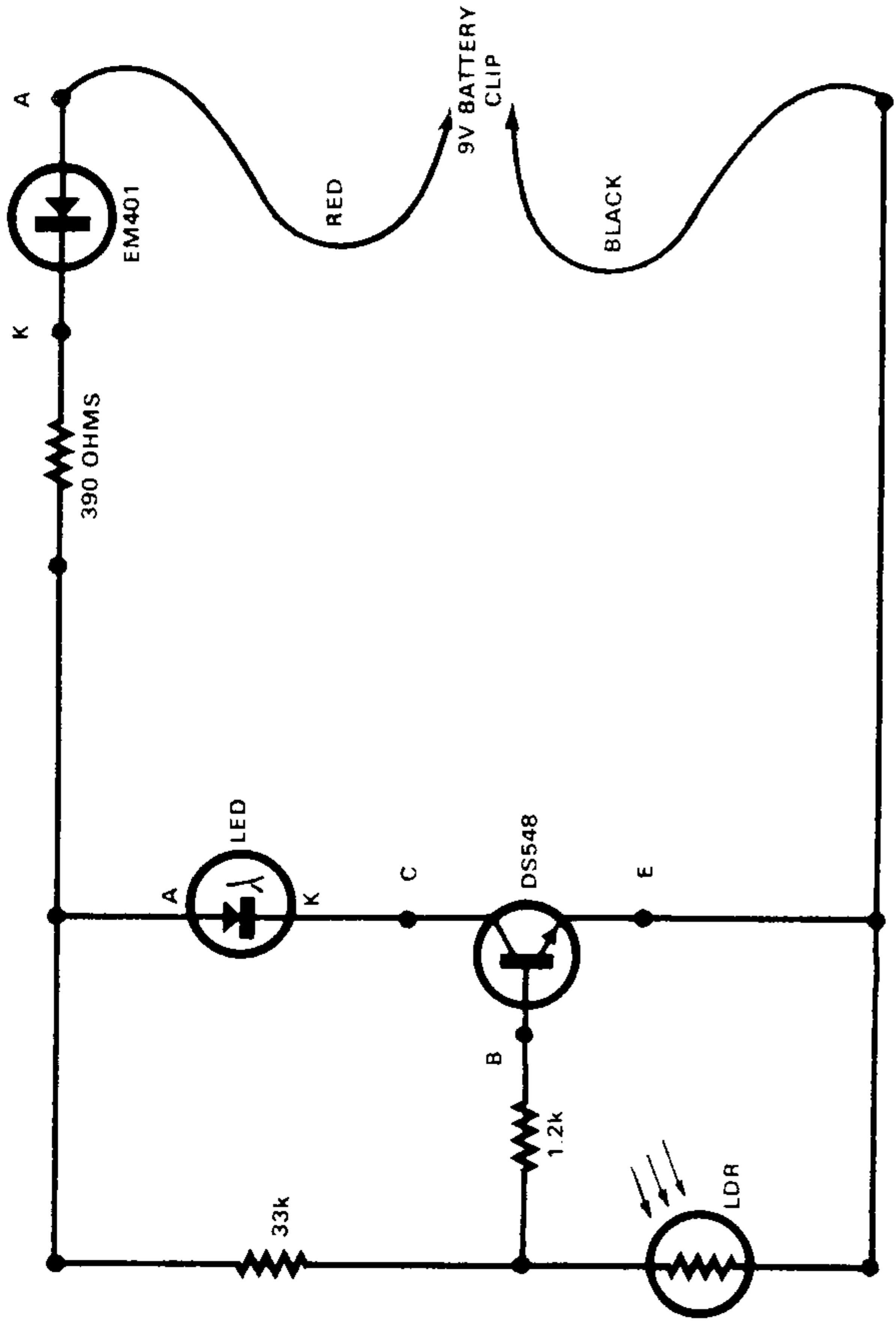

DICK SMITH'S
'FUN WAY INTO ELECTRONICS'
LIGHT/DARK INDICATOR
PROJECT
No. 4

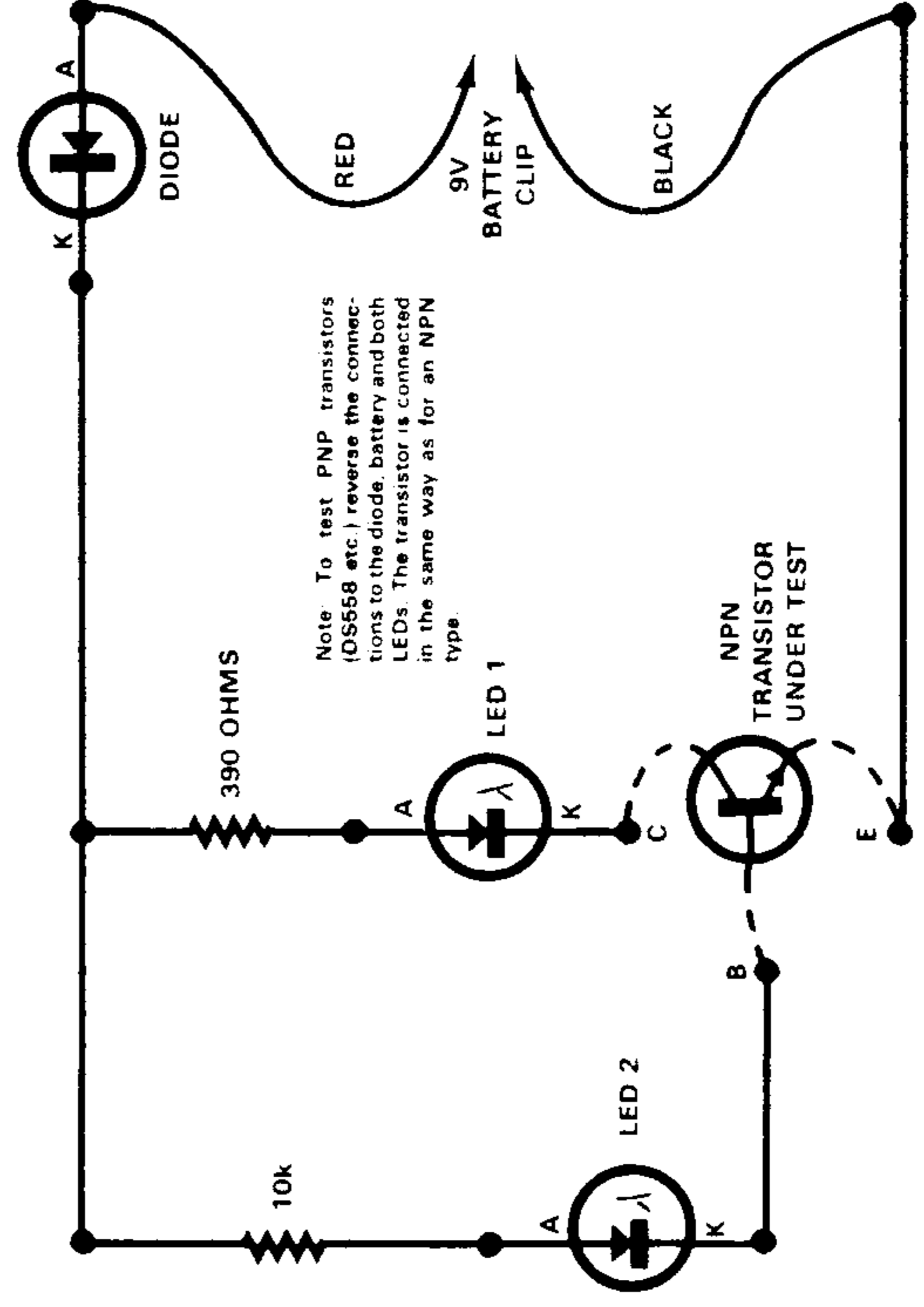

Note: To test PNP transistors (DS568 etc.) reverse the connections to the diode, battery and both LEDs. The transistor is connected in the same way as for an NPN type.

DICK SMITH'S
'FUN WAY INTO ELECTRONICS'
TRANSISTOR CHECKER
PROJECT
No. 2

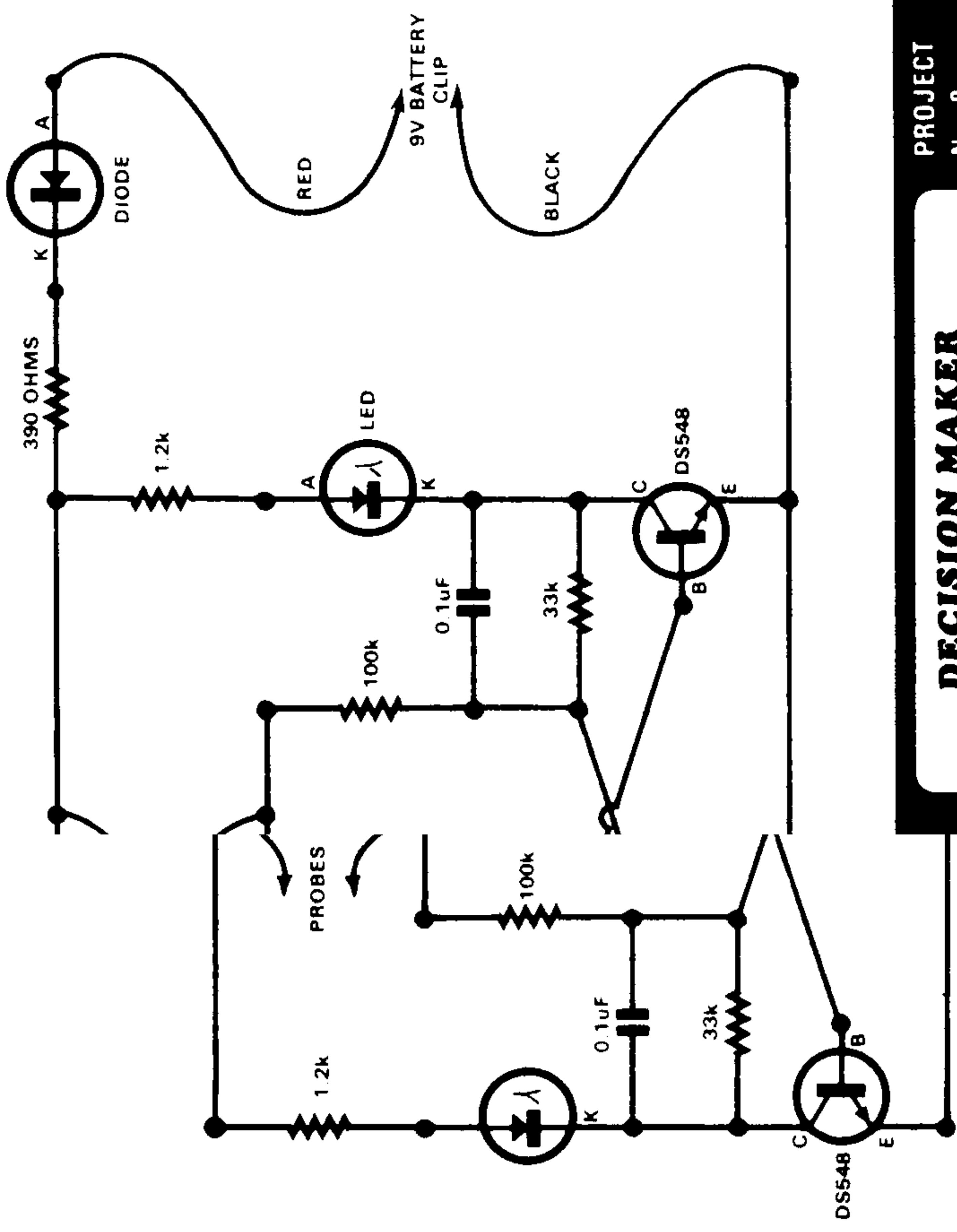
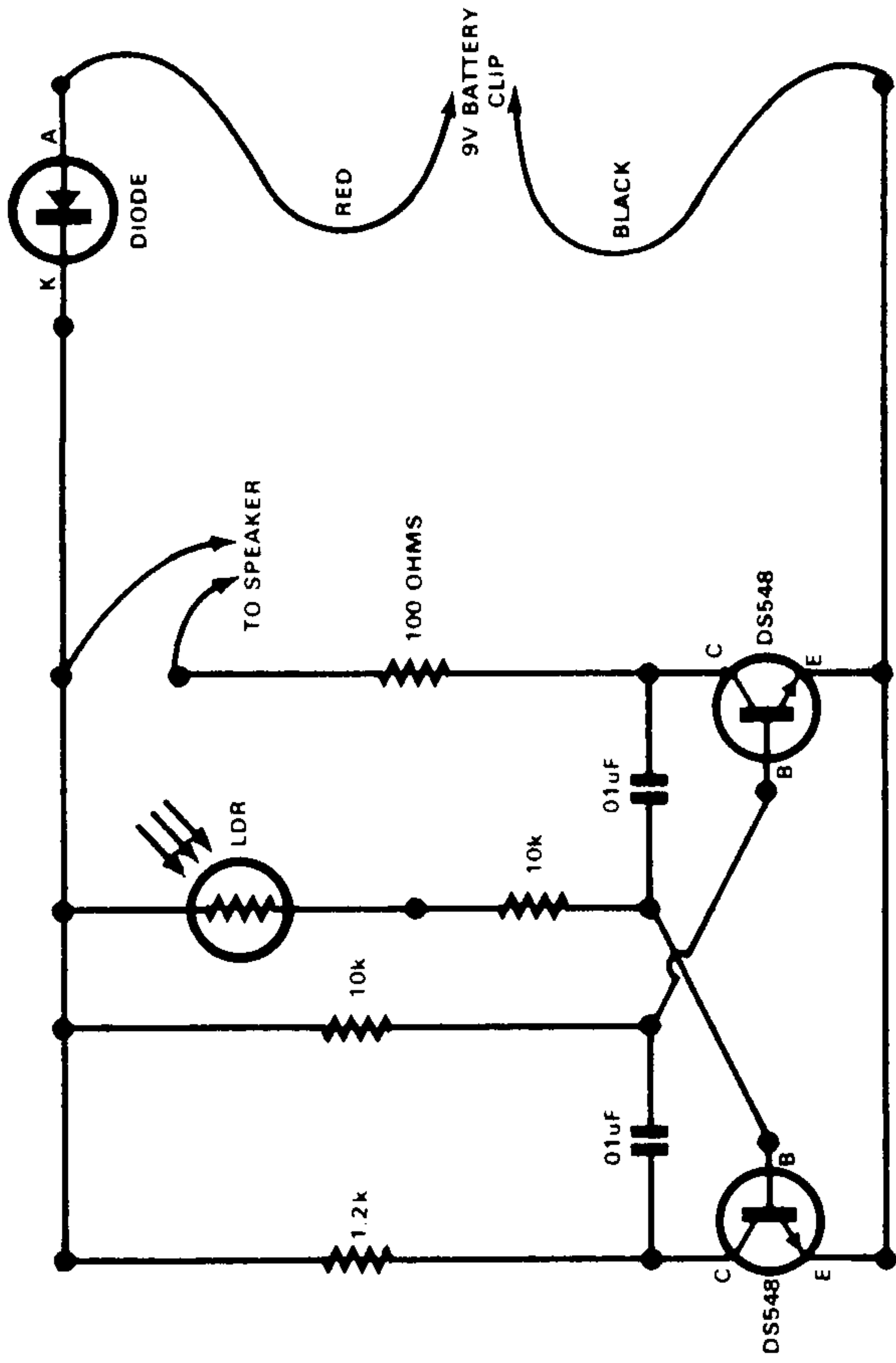

DECISION MAKER

DOG & CAT COMMUNICATOR

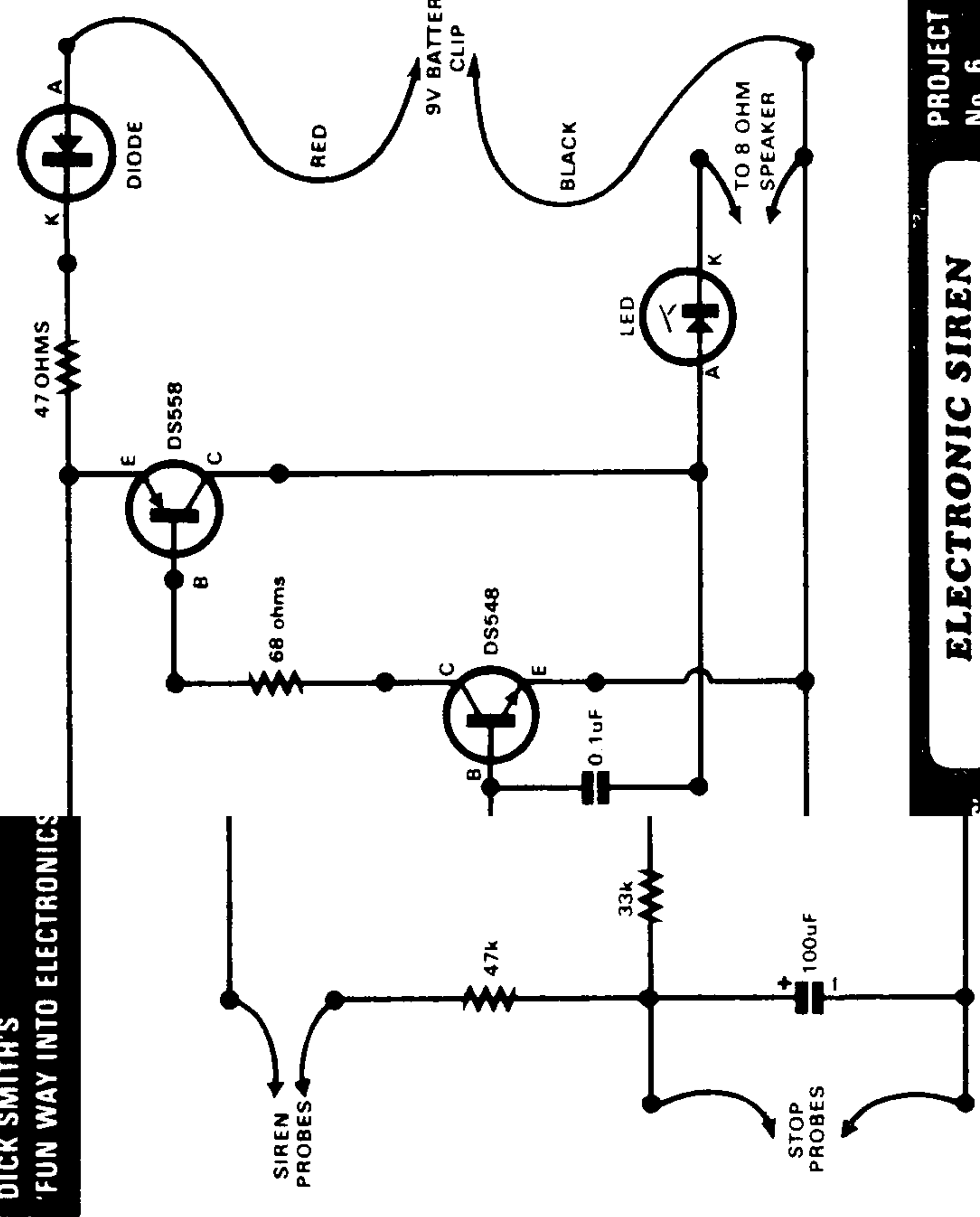
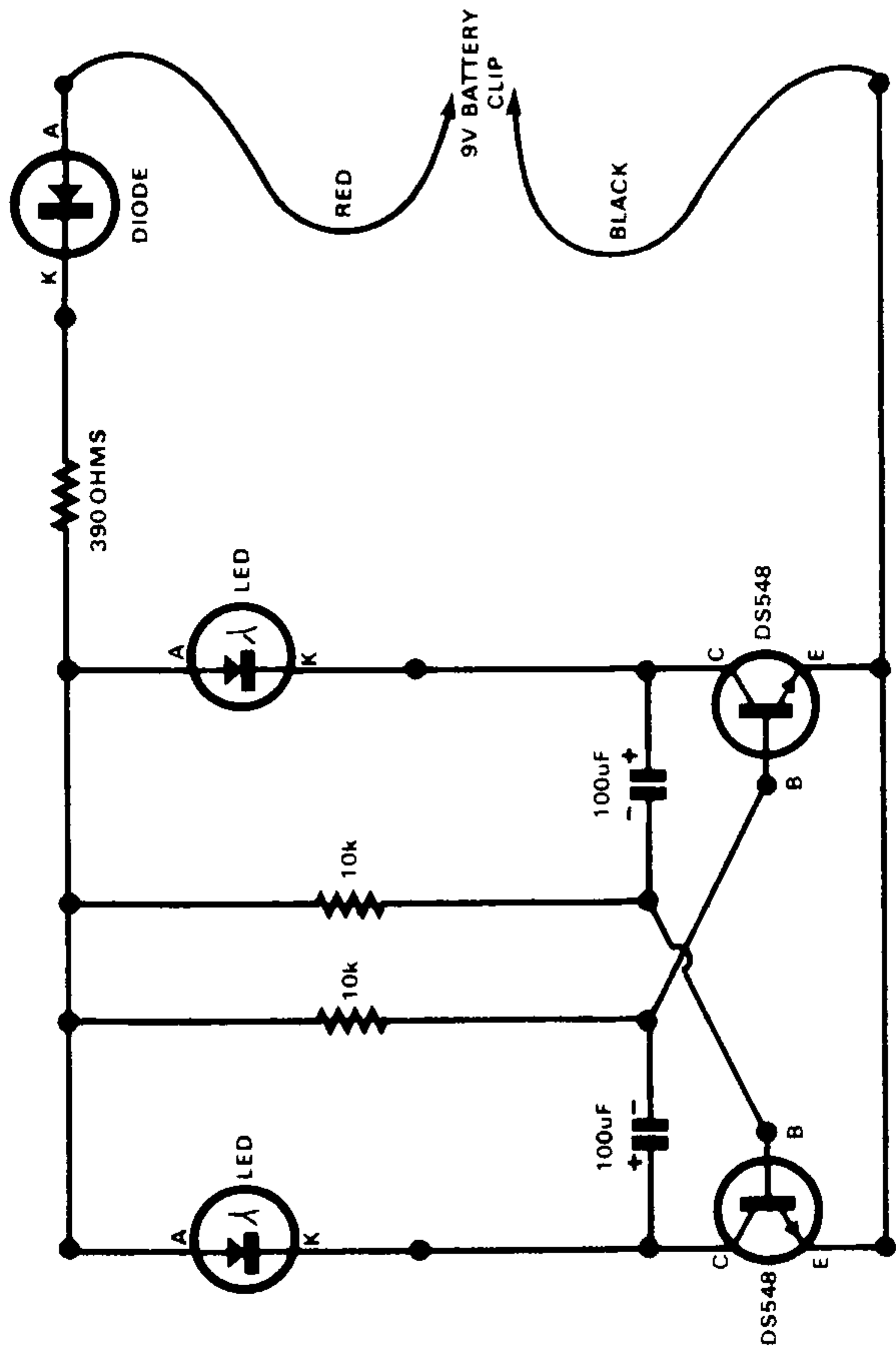

ELECTRONIC SIREN

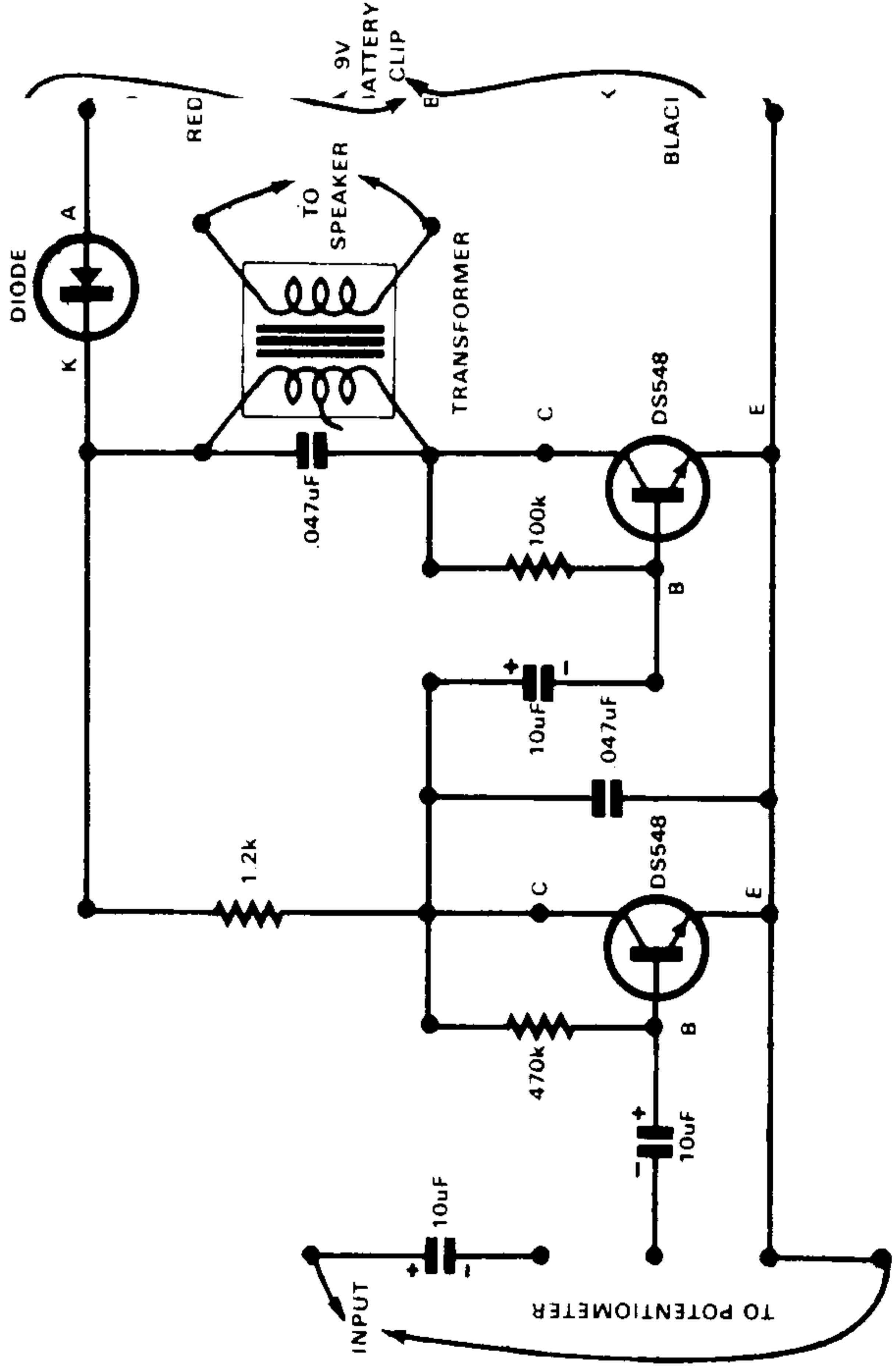

DICK SMITH'S 'FUN WAY INTO ELECTRONICS'
TWO TRANSISTOR AMPLIFIER
 PROJECT No. 15

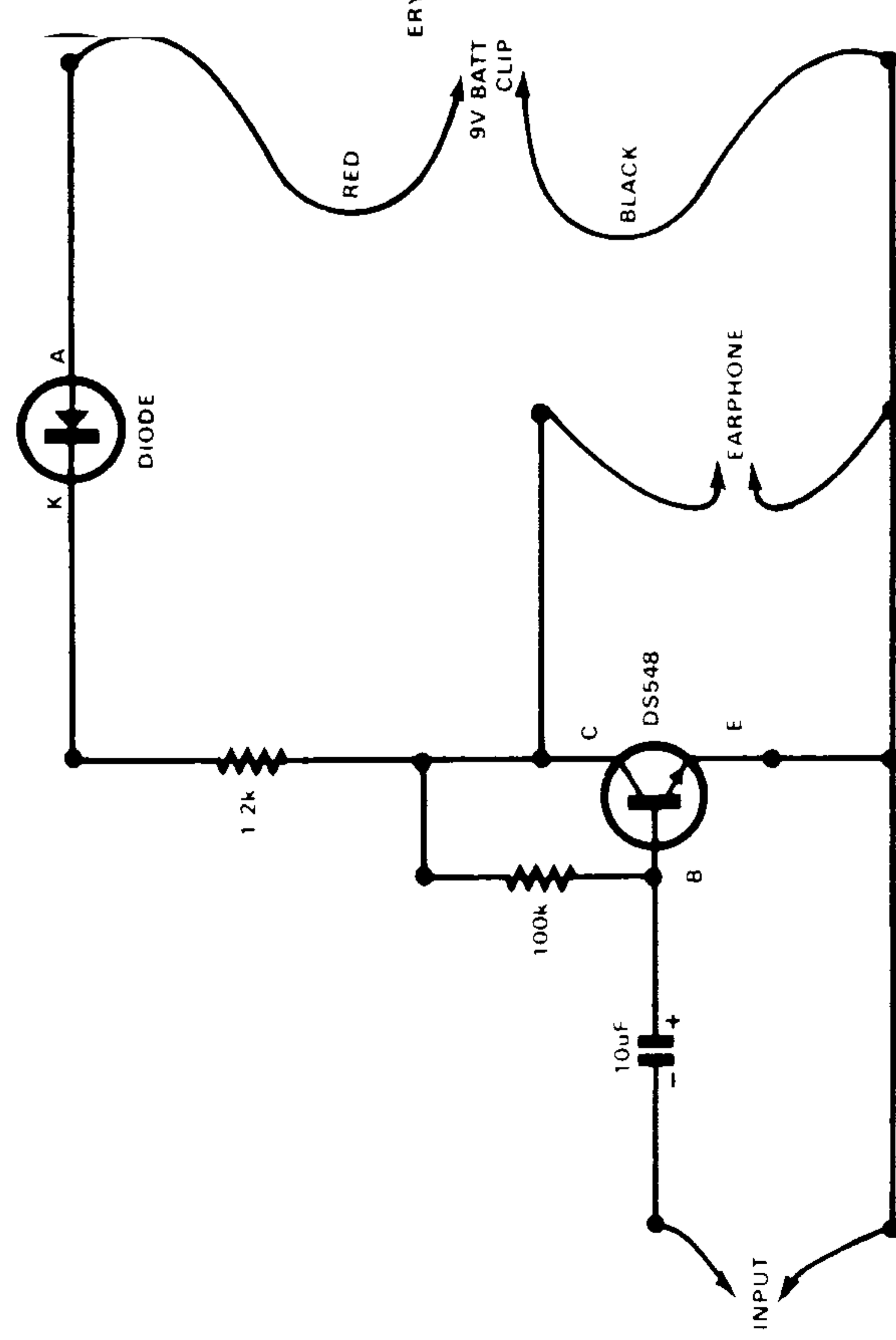

DICK SMITH'S 'FUN WAY INTO ELECTRONICS'
ONE TRANSISTOR AMPLIFIER
 PROJECT No. 13

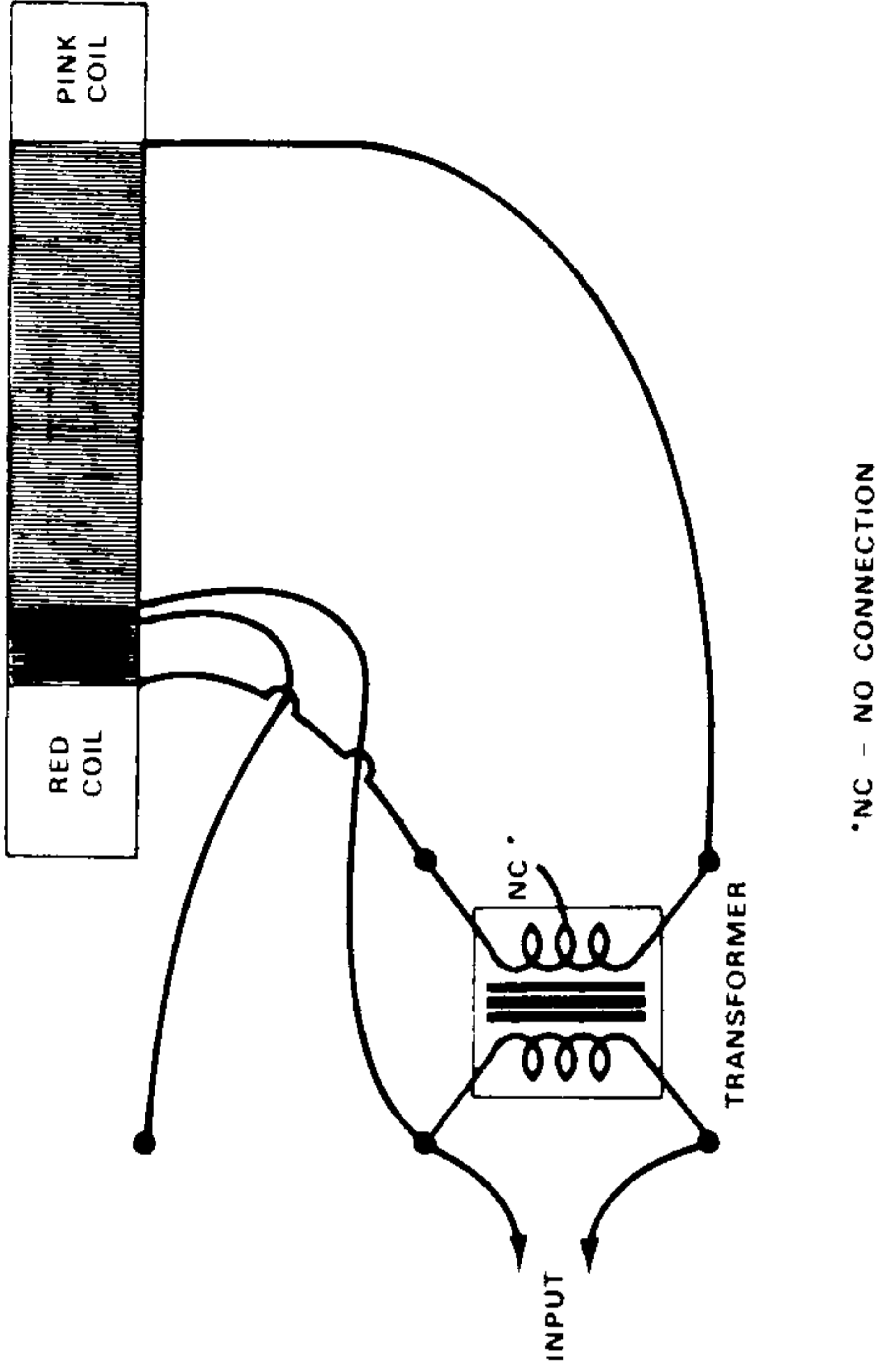

DICK SMITH'S 'FUN WAY INTO ELECTRONICS'
SIMPLEST RADIO TRANSMITTER
 PROJECT No. 16

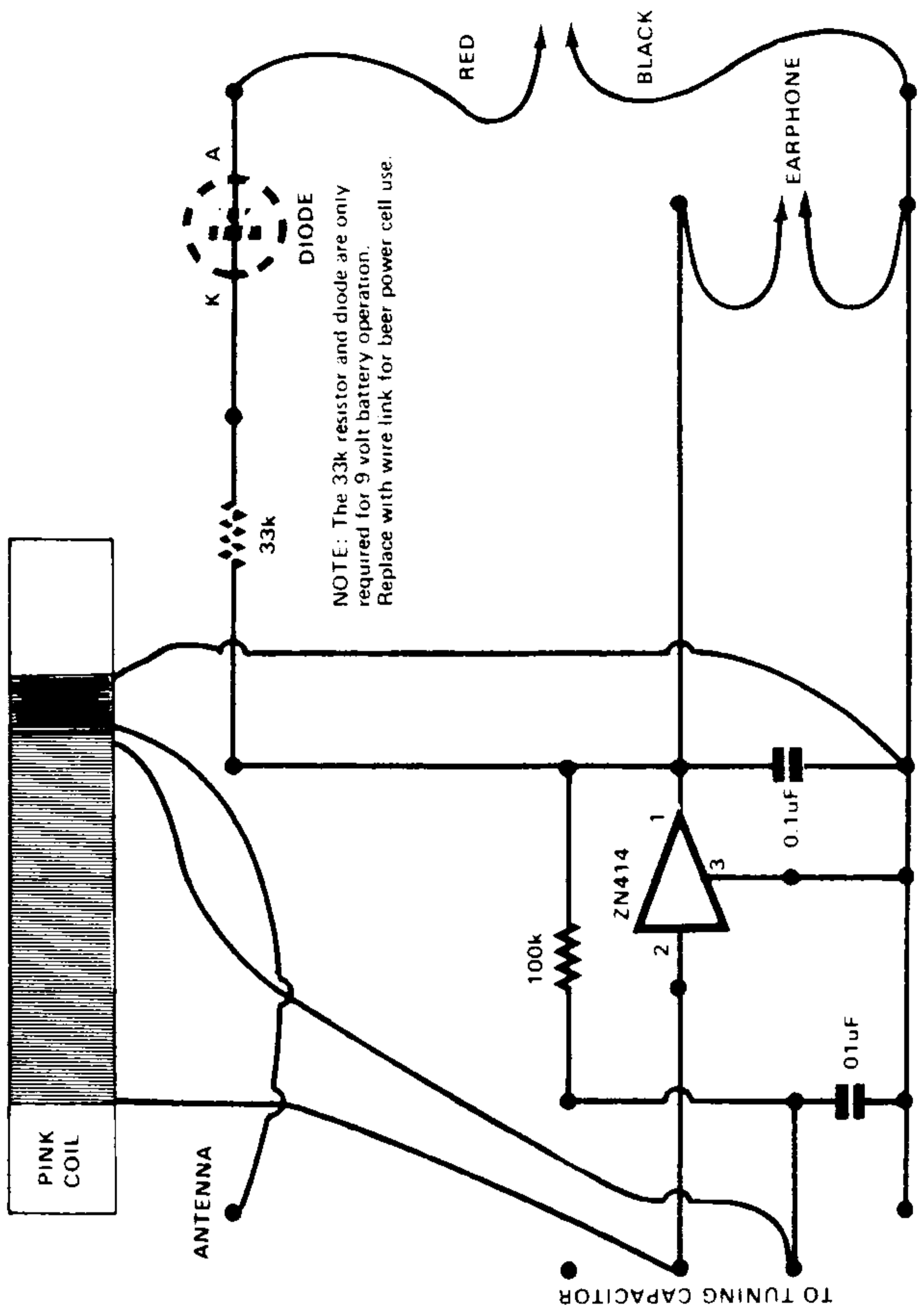

DICK SMITH'S 'FUN WAY INTO ELECTRONICS'
BEER POWERED RADIO
 PROJECT No. 14

NOTE: The 33k resistor and diode are only required for 9 volt battery operation. Replace with wire link for beer power cell use.

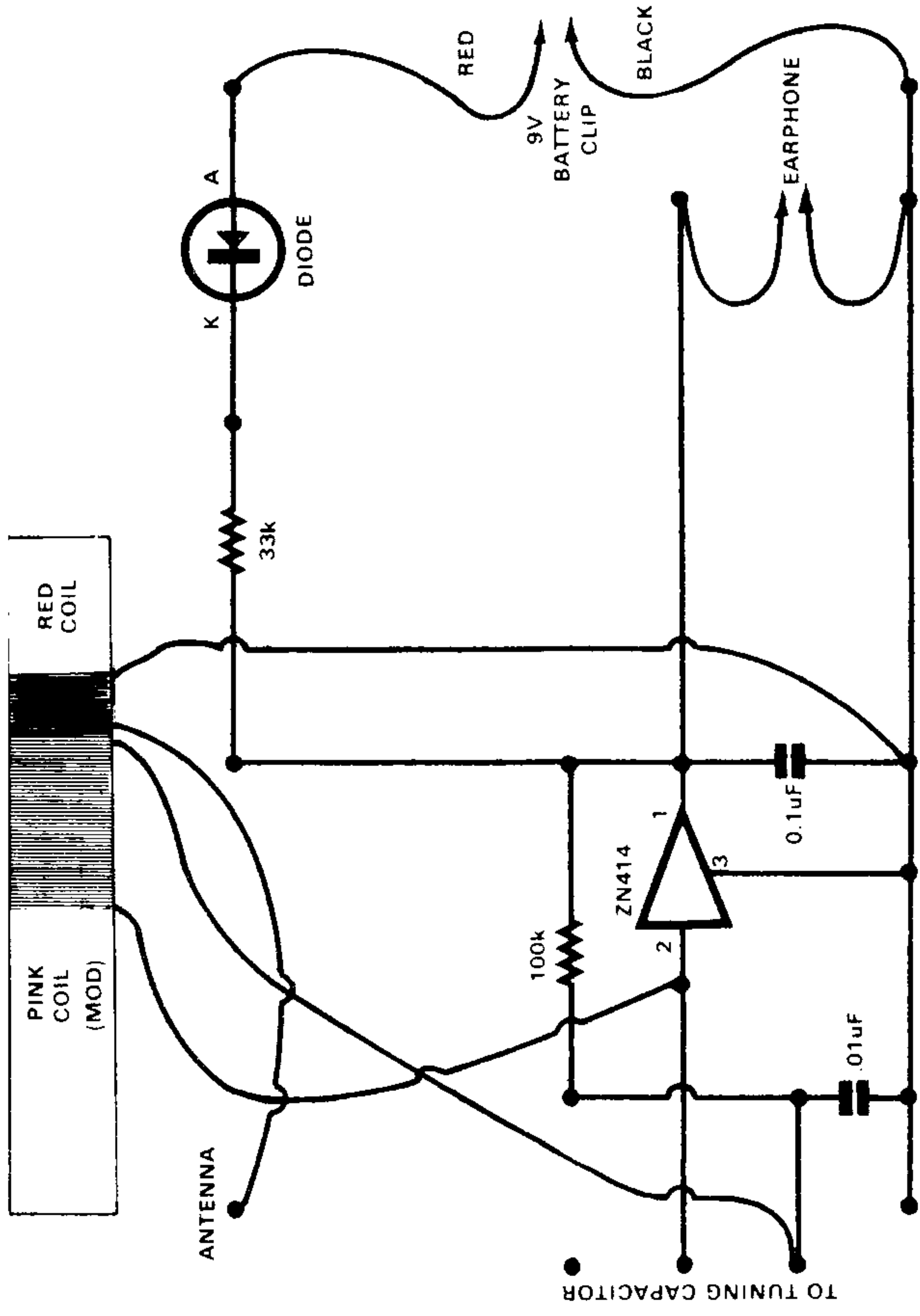

DICK SMITH'S
'FUN WAY INTO ELECTRONICS'

AMATEUR RADIO RECEIVER

PROJECT
No. 19

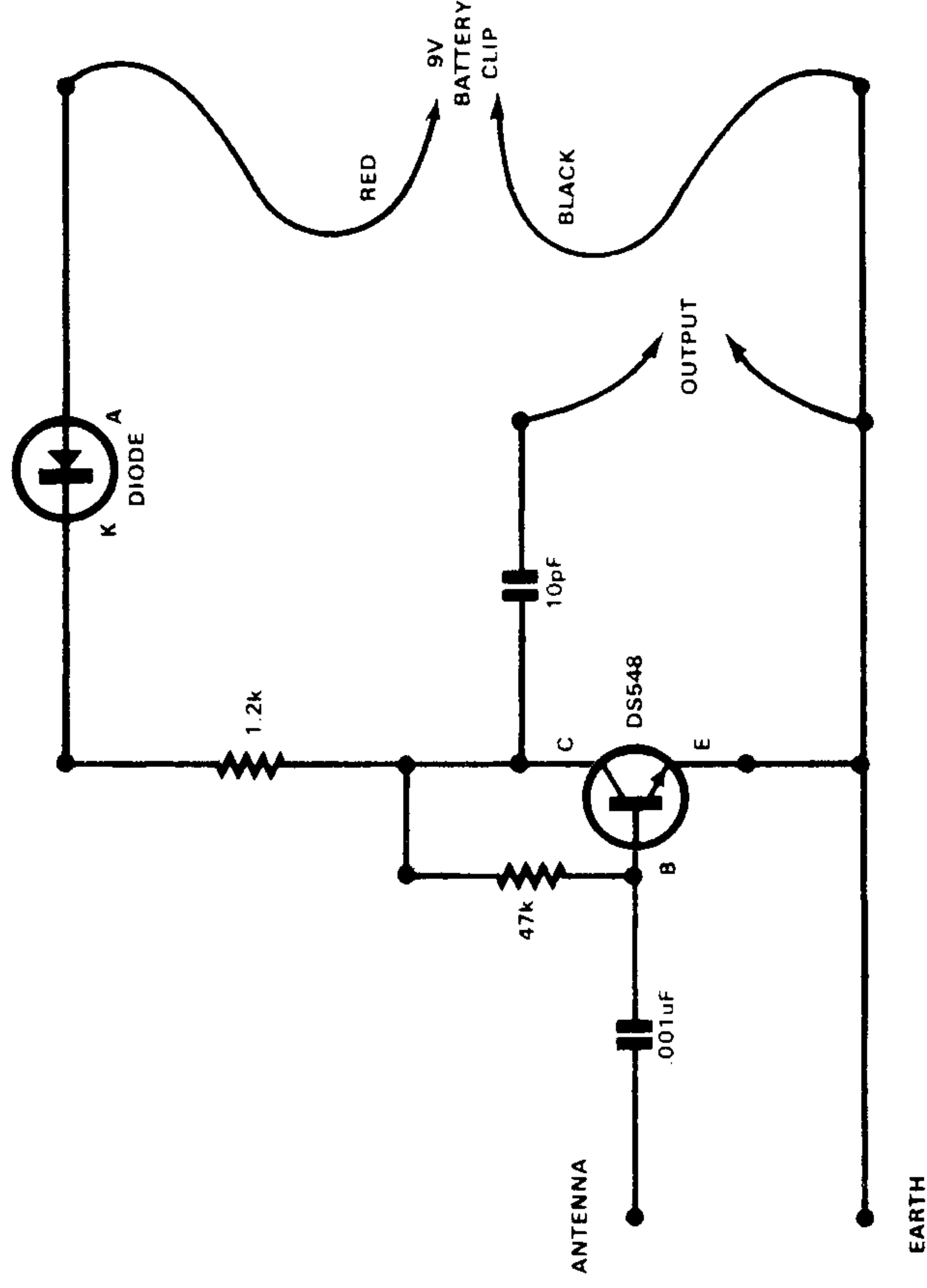

DICK SMITH'S
'FUN WAY INTO ELECTRONICS'

RADIO FREQUENCY AMPLIFIER

PROJECT
No. 20

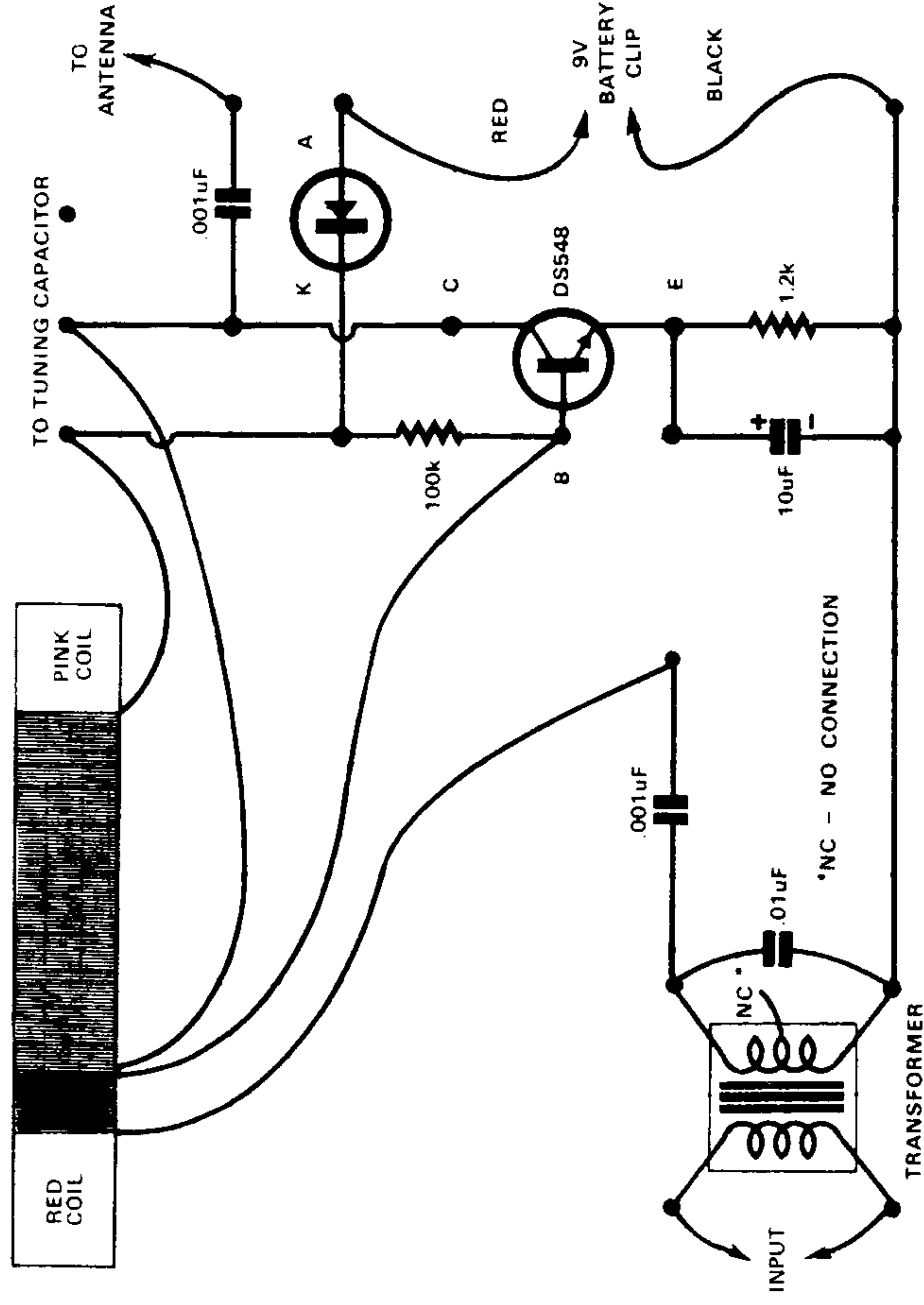

DICK SMITH'S
'FUN WAY INTO ELECTRONICS'

RADIO TRANSMITTER

PROJECT
No. 17

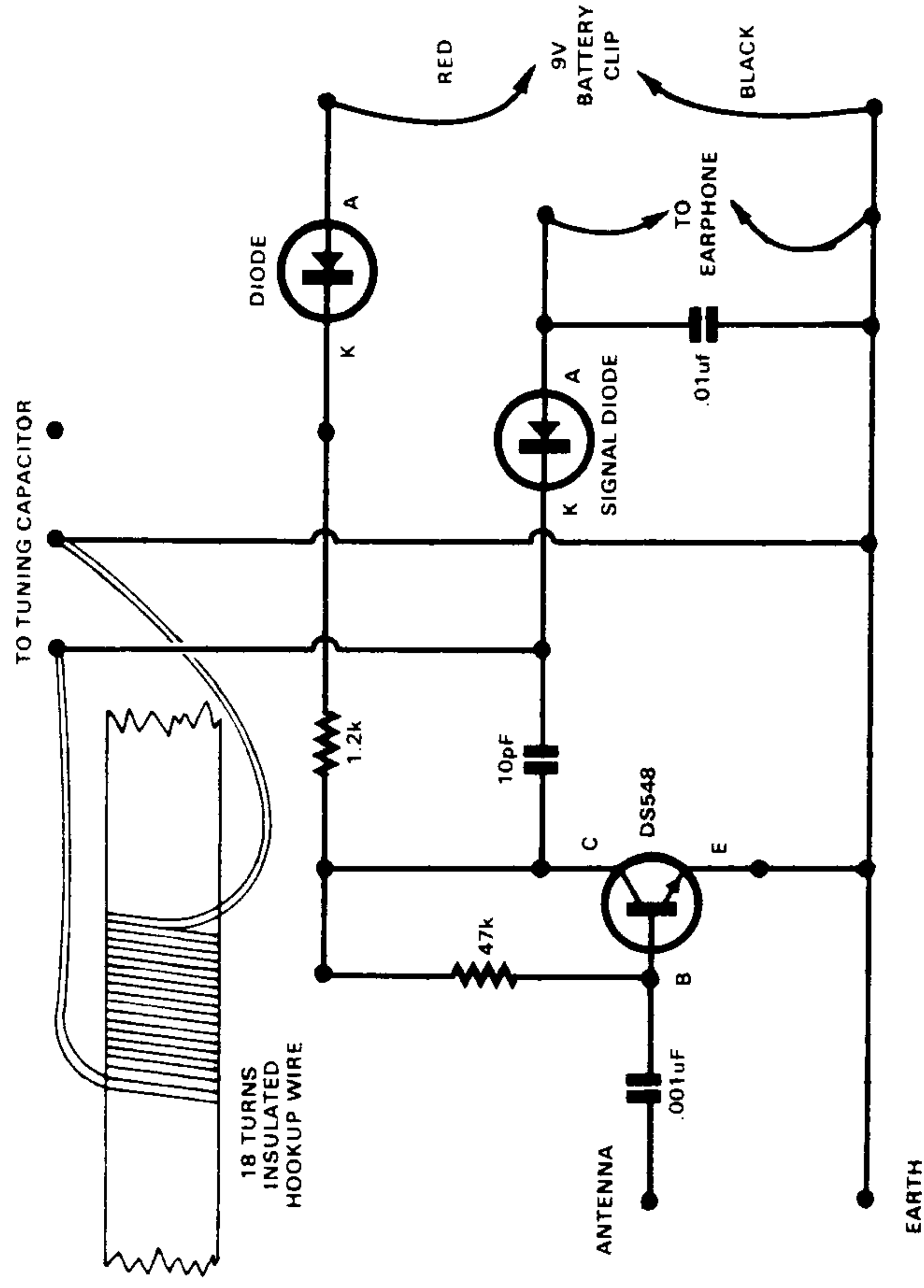

DICK SMITH'S
'FUN WAY INTO ELECTRONICS'

CB RADIO RECEIVER

PROJECT
No. 18

ready to make & you SAVE!

**SCHOOLS, COLLEGES, ETC:
ASK ABOUT OUR
INCREDIBLE DISCOUNTS
FOR BULK ORDERS!**



Kit K-2600 to build

Contains the following parts which allow you to build the first ten projects in the book.

One particle board 10 x 12cm, 28 self tapping screws, 28 washers, 1/2m tinned copper wire, four 30cm lengths of hookup wire, battery clip, 8 ohm speaker. Resistors: 47 ohms, 68 ohms, two 100 ohms, 390 ohms, two 1.2k, 1.5k, four 2.2k, two 3.3k, 3.9k, 4.7k, two 10k, two 33k, 47k, two 100k, ORP12 LDR. Semiconductors: 1N4001 diode, two TIL220R LEDs, two DS548 transistors, two DS558 transistors. Capacitors: two 0.01uF greencap, 10uF 16V electrolytic, two 100uF 10V electrolytic.

**contains over \$1000
worth of
components
at normal
prices**

ONLY

Kit K-2610 to build

Contains the additional parts, which, together with kit K2600, enables you to build the remaining ten projects.

Ferrite rod aerial, crystal earphone, audio transformer, 70cm length of insulated hookup wire. Resistors: 470k, 500k variable potentiometer. Semiconductors: OA91 diode, ZN414 integrated circuit. Capacitors: two 0.01uF disc, two 0.001uF disc, 0.1uF disc, 0.047uF disc, 10pF disc, 0.047uF greencap, two 10uF 16V electrolytics, 60 to 160pF variable.

**contains over \$1200
worth of
components
at normal
prices.**

ONLY

available from our stores at:

NSW 145 Parramatta Rd	AUBURN 648 0558	125 York St	SYDNEY 290 3377	Ross Smith Ave & Nepean Hwy	FRANKSTON 783 9144
755 Terrace Level	BANKSTOWN SQ 707 4888	173 Maitland Rd	TIGHES HILL 61 1896	QLD 166 Logan Rd	BURANDA 391 6233
613 Princes Hwy.	BLAKEHURST 546 7744	263 Keira St	WOLLONGONG 28 3800	842 Gympie Rd	CHERMESIDE 59 6255
552 Oxford St	BONDI JNC 387 1444	Tamworth Acde & Kable Ave	TAMWORTH 66 1961	SA 60 Wright St	ADELAIDE 212 1962
818 George St	BROADWAY 211 3777	ACT 96 Gladstone St	FYSHWICK 80 4944	435 Main North Rd	ENFIELD 260 6088
531 Pittwater Rd	BROOKVALE 93 0441	VIC 399 Lonsdale St	MELBOURNE 67 9834	Main South & Flagstaff Rds	DARLINGTON 298 8977
147 Hume Hwy	CHULLORA 642 8922	260 Sydney Rd	COBURG 383 4455	WA Wharf St & Albany Hwy	CANNINGTON 451 8666
162 Pacific Hwy	GORE HILL 439 5311	656 Bridge Rd	RICHMOND 428 1614	414 William St	PERTH 328 6944
396 Lane Cove Rd	NORTH RYDE 888 3200	Springvale & Dandenong Rds	SPRINGVALE 547 0522	TAS 25 Barrack St	HOBART 31 0800
30 Grose St	PARRAMATTA 683 1133	205 Melbourne Rd	GEE LONG 78 6363		

Dick Smith Mail Order Centre, PO Box 321, North Ryde, NSW 2113.

then Fun Way 2 is for you!

Had your fun with Fun Way number one? Then you are probably ready to try the exciting, fascinating and practical projects in Dick Smith's Fun Way into Electronics Volume 2.

Look at these features:

- ★ 20 practical, educational projects from a wireless microphone to electronic jewellery.
- ★ Beautifully clear, step-by-step instructions.
- ★ Full information on how to solder.
- ★ How to make your own printed circuit boards.
- ★ Plus details of dozens of extra, useful devices you can make by combining your projects.
- ★ Plus pre-printed labels to give your projects a professional finish.

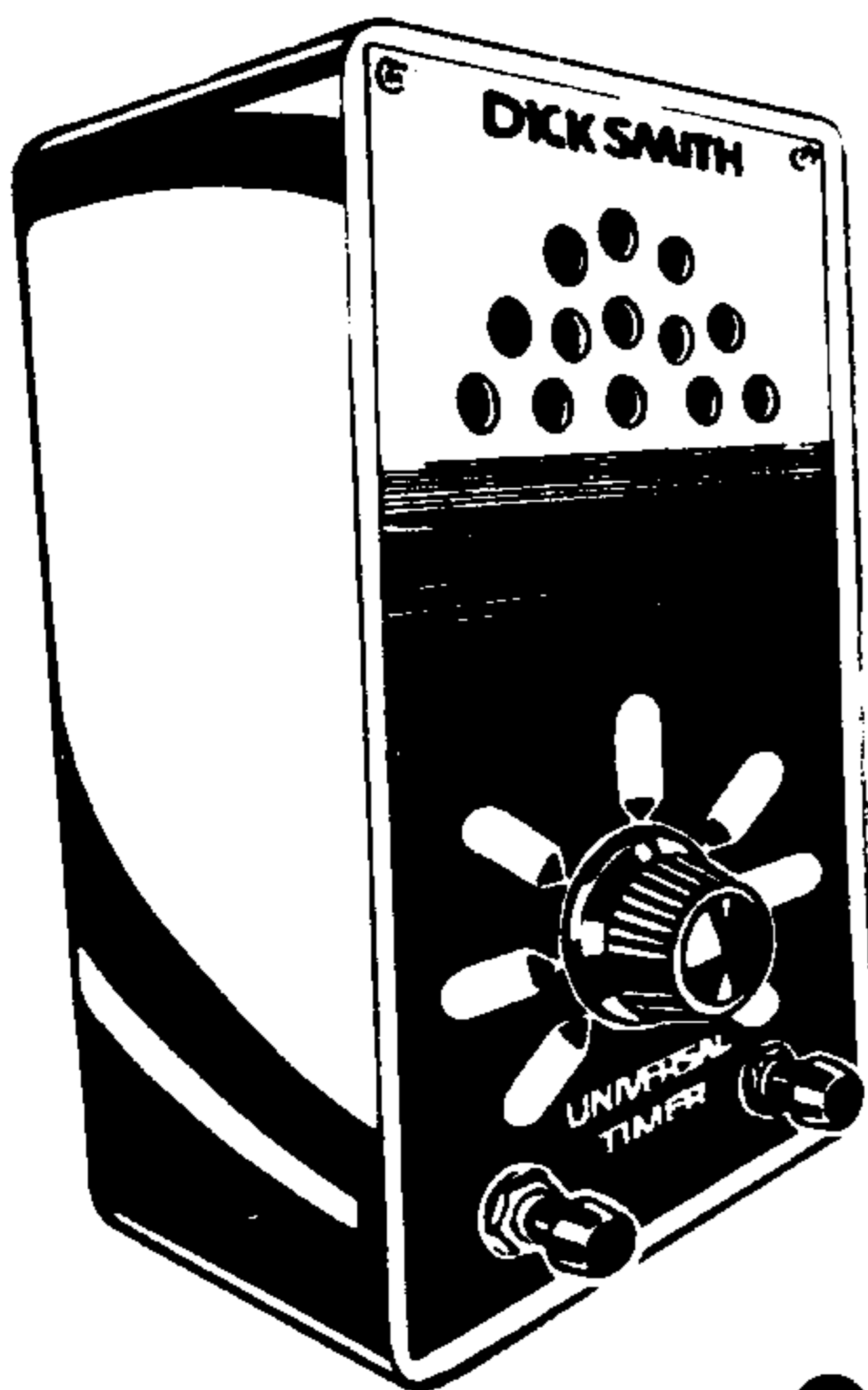
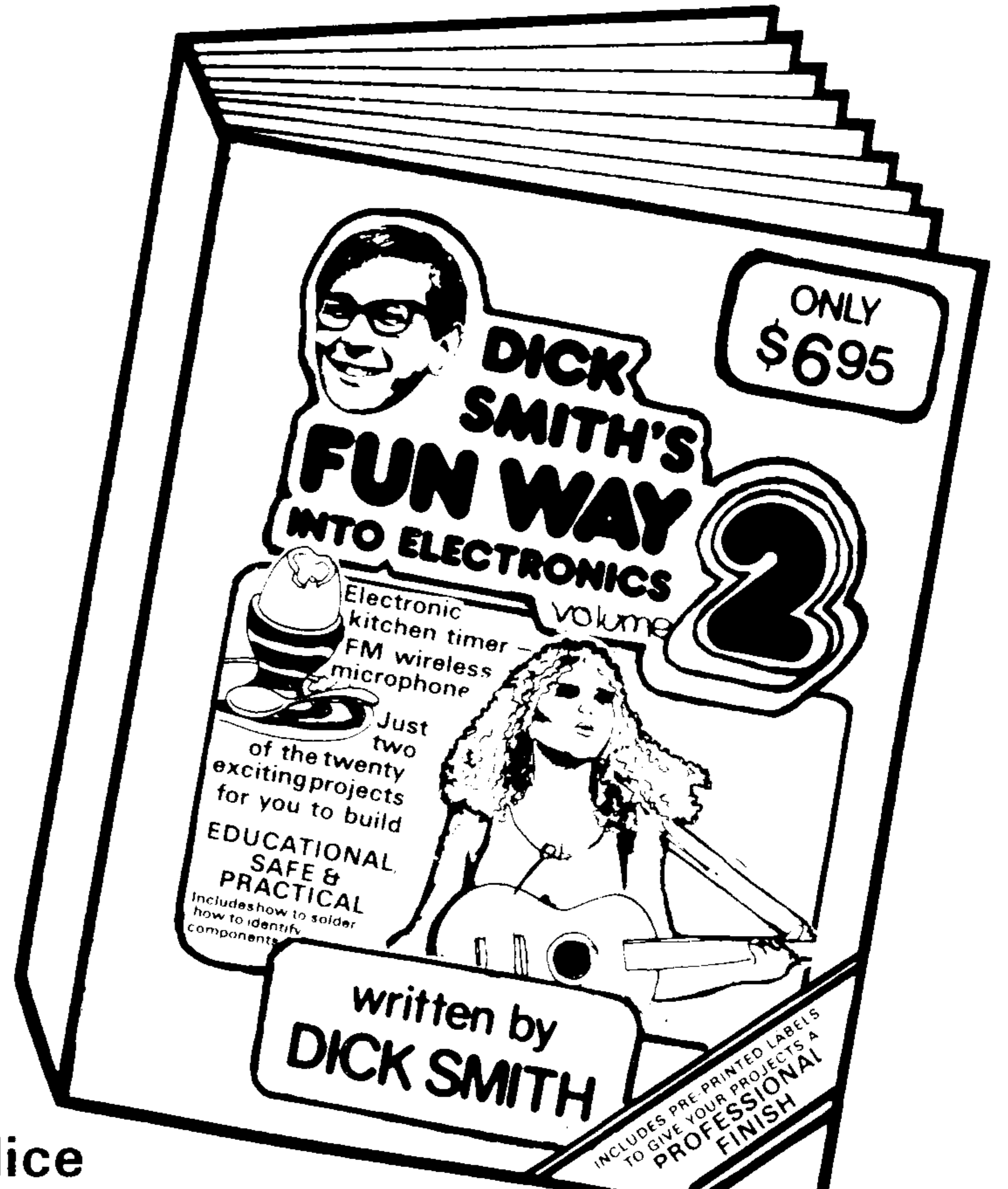

● universal timer

● transistor radio

● monophonic organ

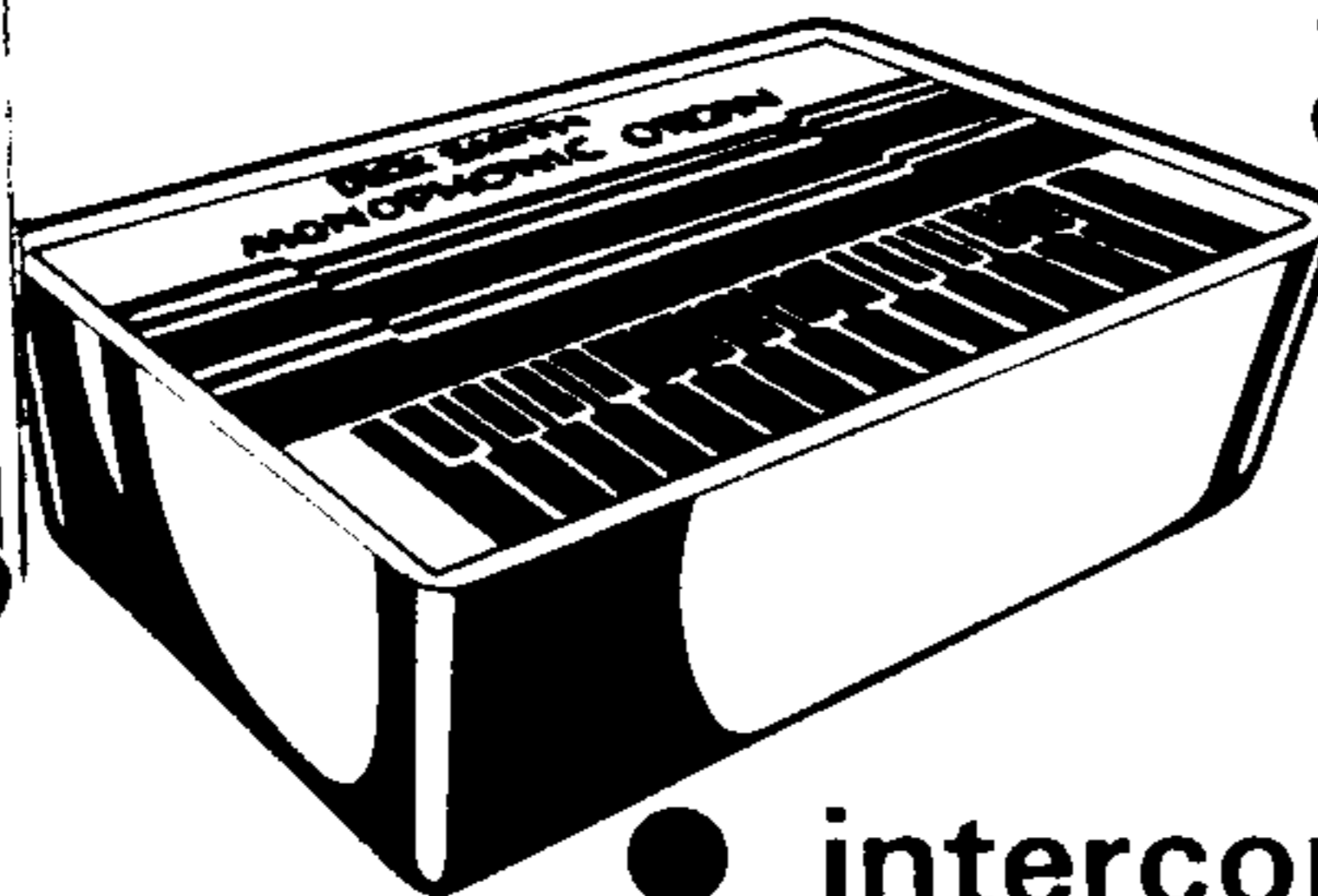

● FM transmitter

● intercom

● LED dice

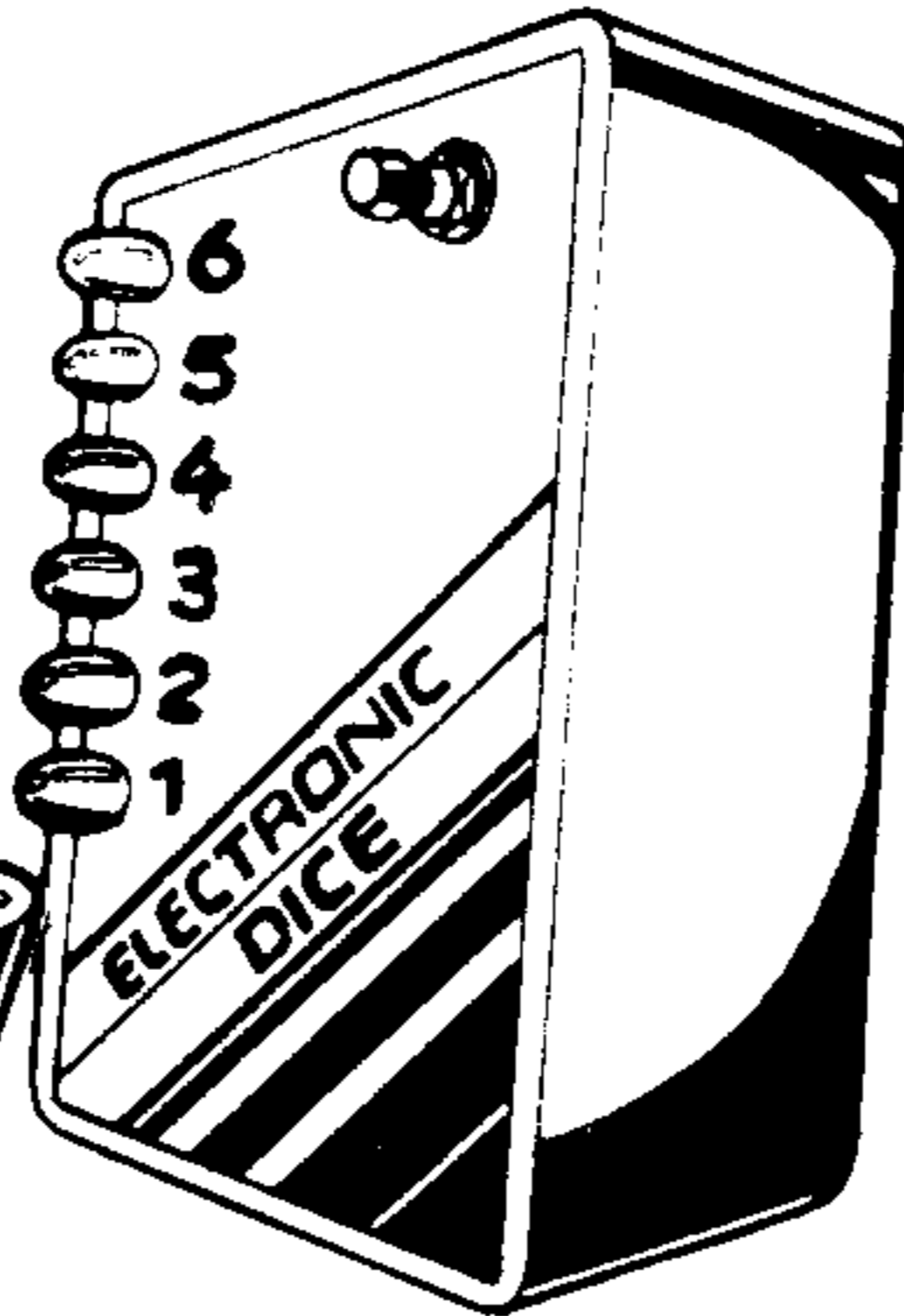

SAME GREAT VALUE!

Cat. B-2605

complete kits available for each project

Each kit contains all components & printed circuit board to make a project work. Mounted in your own box or one of our zippy boxes (not supplied) with the pre-printed label applied you'll have a professional looking & useful project.

from **\$2.75** only
(LED flasher kit)

available from our stores at:

NSW 145 Parramatta Rd	AUBURN 648 0558	125 York St	SYDNEY 290 3377	Ross Smith Ave & Nepean Hwy	FRANKSTON 783 9144
T55 Terrace Level	BANKSTOWN SQ 707 4888	173 Maitland Rd	TIGHES HILL 61 1896	QLD 166 Logan Rd	BURANDA 391 6233
613 Princes Hwy.	BLAKEHURST 546 7744	263 Keira St	WOLLONGONG 28 3800	842 Gympie Rd	CHERMESIDE 59 6255
552 Oxford St	BONDI JNC 387 1444	Tamworth Acde & Kable Ave	TAMWORTH 66 1961	SA 60 Wright St	ADELAIDE 212 1962
818 George St	BROADWAY 211 3777	ACT 96 Gladstone St	FYSHWICK 80 4944	435 Main North Rd	ENFIELD 260 6088
531 Pittwater Rd	BROOKVALE 93 0441	VIC 399 Lonsdale St	MELBOURNE 67 9834	Main South & Flagstaff Rds	DARLINGTON 298 8977
147 Hume Hwy	CHULLORA 642 8922	260 Sydney Rd	COBURG 383 4455	WA Wharf St & Albany Hwy	CANNINGTON 451 8666
162 Pacific Hwy	GORE HILL 439 5311	656 Bridge Rd	RICHMOND 428 1614	414 William St	PERTH 328 6944
396 Lane Cove Rd	NORTH RYDE 888 3200	Springvale & Dandenong Rds	SPRINGVALE 547 0522	TAS 25 Barrack St	HOBART 31 0800
30 Grose St	PARRAMATTA 683 1133	205 Melbourne Rd	GEE LONG 78 6363		

Dick Smith Mail Order Centre, PO Box 321, North Ryde, NSW 2113.

By the same author:

Australian CB Radio Handbook

Australian amateur Radio Handbook

First Published 1979

Second Printing 1979

Third Printing 1980

Fourth Printing 1981

Fifth Printing 1982

Sixth Printing 1984

Seventh Printing 1984

Eighth Printing 1985

**by Dick Smith Management Pty Ltd
Cnr Lane Cove Road and Waterloo Road,
North Ryde, NSW 2113**

**Distributed by
Dick Smith Distributors
Cnr Lane Cove Road and Waterloo Road,
North Ryde, NSW 2113**

Copyright © 1979 by Dick Smith Electronics

**National Library of Australia Card Number
and ISBN 0 9595080 0 7**

**Printed in Australia by
The Dominion Press-Hedges & Bell,
Maryborough, 3465**

*** Recommended price only**

TWENTY EXCITING PROJECTS FOR YOU TO BUILD

A water indicator

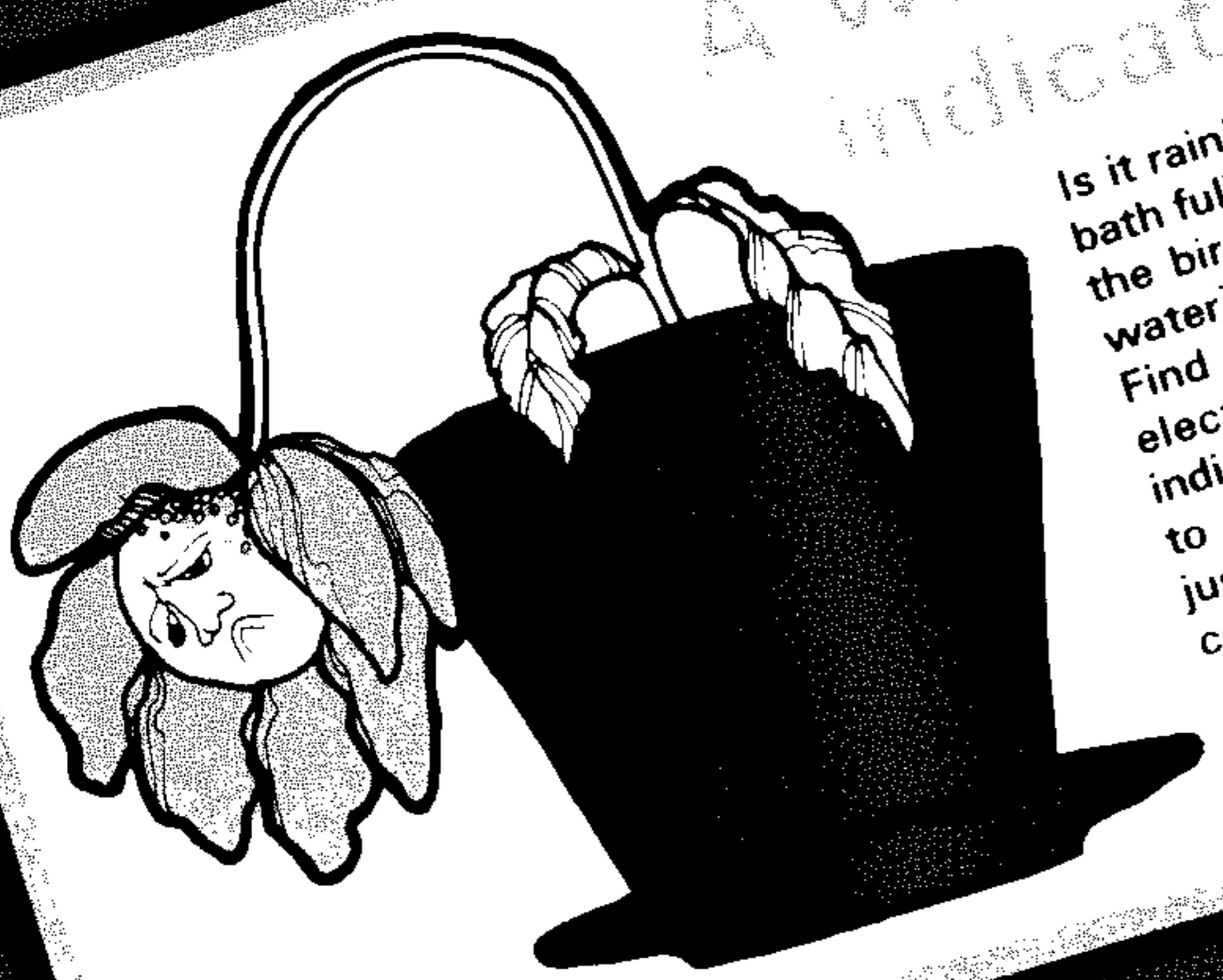

Is it raining? Is the bath full yet? Does the birdcage need water? Find out with this electronic water indicator. It's easy to build and uses just a couple of components.

Morse code communicator



Learn exciting Morse code with the great Morse code communicator. Talk to the world!

A decision maker

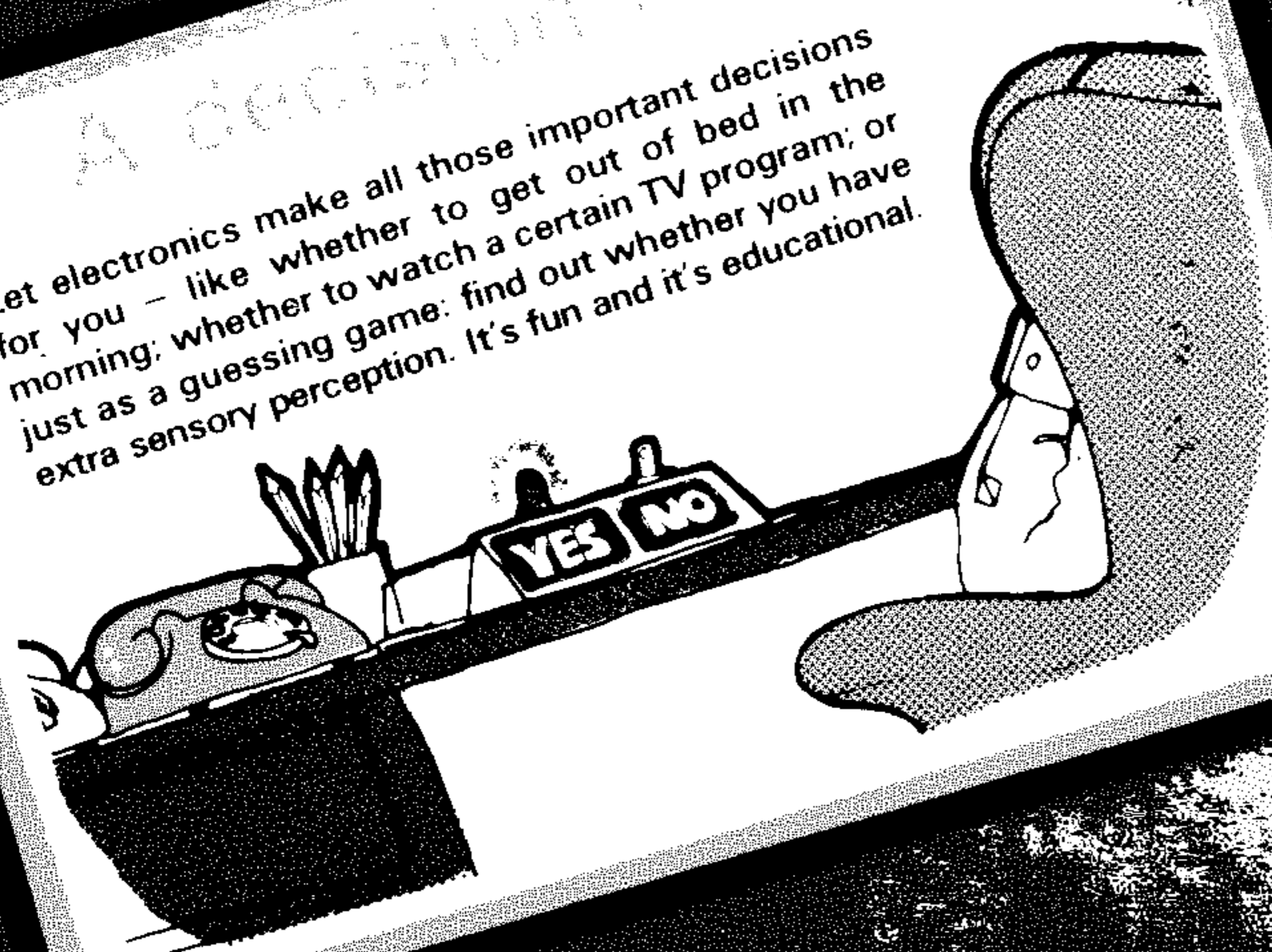

Let electronics make all those important decisions for you - like whether to get out of bed in the morning, whether to watch a certain TV program, or just as a guessing game: find out whether you have extra sensory perception. It's fun and it's educational.

An electronic siren

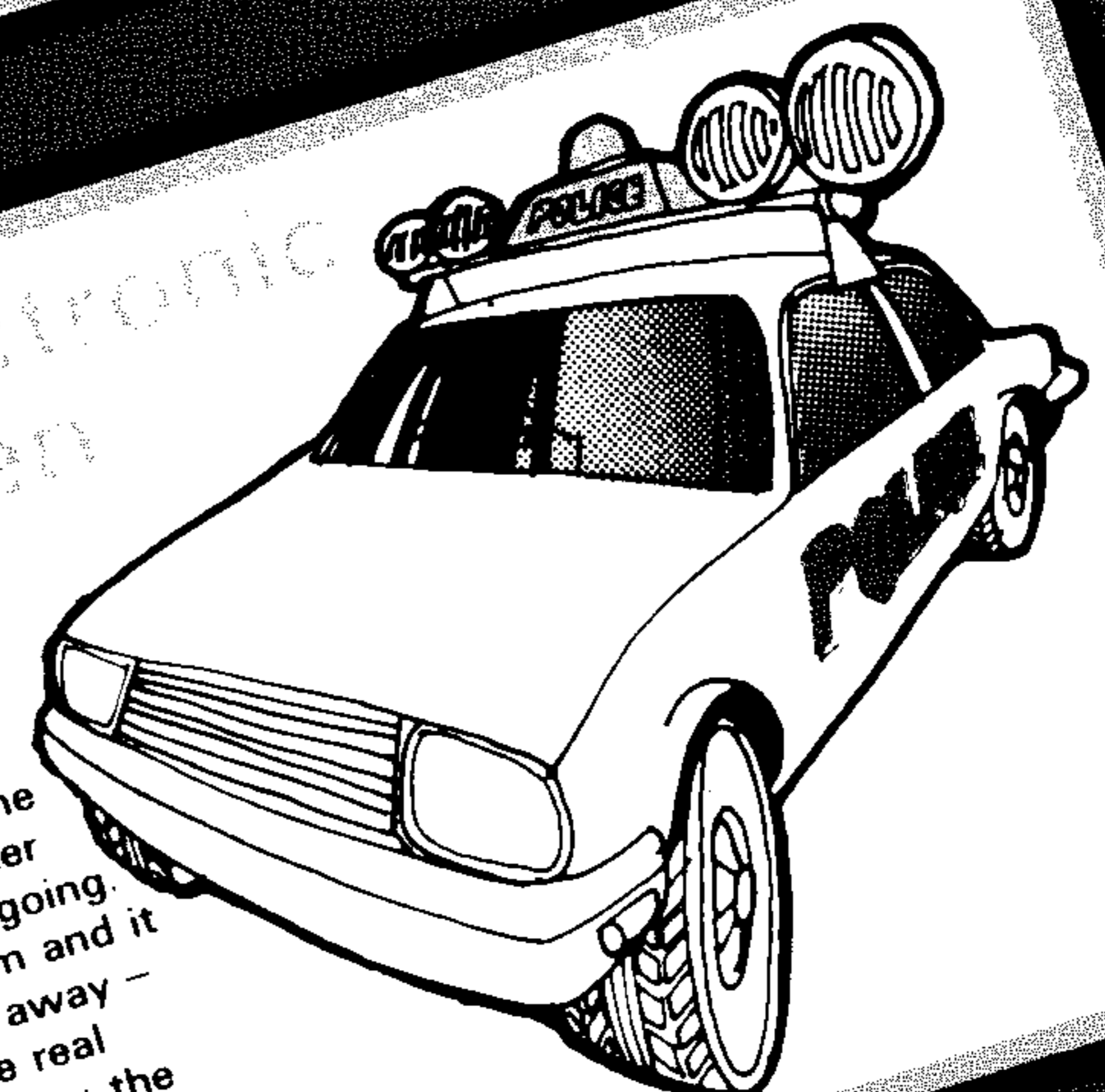

Is it the police? No! It is only you with your version of a siren. Touch the probes together and it starts going. Release them and it slowly dies away - just like the real thing. Imagine: the only siren-equipped pushbike on your street!